

2020 form five biology notes

Table of Contents

TOPIC 1: LEVELS OF ORGANISATION AND DIVERSITY OF LIFE	7
Syllabus extract.....	7
IMPORTANCE OF STUDYING BIODIVERSITY	9
SPECIMEN IDENTIFICATION AND KEYS	9
THE DOMAIN SYSTEM	10
THE FIVE KINGDOMS	10
VIRUSES	10
KINGDOM PROKARYOTAE/MONERA	12
KINGDOM PROTISTA	14
KINGDOM FUNGI	16
KINGDOM PLANTAE (plants)	18
ALTERNATION OF GENERATION	19
KINGDOM ANIMALIA	23
Sample questions	32
REFERENCES	35
TOPIC 2: CHEMICALS OF LIFE	36
Syllabus extract.....	36
Introduction	39
INORGANIC CHEMICALS OF LIFE	39
ACIDS AND BASES	39
MINERAL ELEMENTS	40
WATER	43
THE ORGANIC CHEMICALS OF LIFE	47
VITAMINS	48
CARBOHYDRATES	49
LIPIDS (fats and oils)	58
PROTEINS	61
ENZYMES	70
REVISION QUESTIONS	79
REFERENCES	85
TOPIC 3: INHERITANCE	86
SYLLABUS EXTRACT	86
NUCLEIC ACIDS	88

PROTEIN SYNTHESIS	96
CELL DIVISION.....	99
THE CELL CYCLE.....	99
MITOSIS.....	100
MEIOSIS.....	103
GENETICS	109
MENDEL'S GENETIC EXPERIMENTS AND MONOHYBRID INHERITANCE	110
MENDEL'S FIRST LAW OF INHERITANCE.....	112
CO-DOMINANCE	119
INCOMPLETE DOMINANCE	124
MULTIPLE ALLELES	125
Inheritance of ABO blood system	126
DIHYBRID INHERITANCE	129
INHERITANCE OF COMPLEMENTARY GENES	132
MODIFICATION OF 9:3:3:1 PHENOTYPIC RATIO.....	134
EPISTASIS.....	134
CROSSOVER VALUE AND CHROMOSOME MAPS.....	139
INHERITANCE OF SEX	142
Pedigree charts.....	147
VARIATION.....	149
OUT OF CLASS EXERCISES	158
TOPIC 4: CYTOLOGY, MICROSCOPY AND HISTOLOGY	177
Syllabus extract.....	177
CELL BIOLOGY	178
TYPES OF CELLS.....	179
MICROSCOPY	184
CELL STRUCTURE.....	187
The nucleus	193
Mitochondria	194
Chloroplast.....	195
Ribosomes.....	197
Endoplasmic reticulum	197
Lysosomes (suicide bag).....	198
Golgi apparatus/body.....	200
Plant cell wall.....	202
Flagella and cilia	204

Microbodies.....	204
Vacuoles.....	204
Protoplasm	205
Microtubules	205
HISTOLOGY.....	207
HISTOLOGY OF PLANTS	207
MERISTEMS.....	207
PERMANENT TISSUES	207
THE VASCULAR TISSUE.....	210
HISTOLOGY OF ANIMALS	214
EPITHELIAL TISSUE	214
CONNECTIVE TISSUE.....	220
SAMPLE QUESTIONS	225
REFERENCES	229
TOPIC 5: MOVEMENT IN AND OUT OF CELLS	230
Syllabus extract.....	230
Introduction	230
SIMPLE DIFFUSION.....	231
FACILITATED DIFFUSION	232
ACTIVE TRANSPORT.....	234
OSMOSIS.....	236
Water potential	237
Solute potential (Ψ_s)	238
Pressure potential (Ψ_p).....	238
Osmosis and plant cells	239
Plant-water relations	241
Osmosis and animal cells	243
BULK TRANSPORT ACROSS THE CELL MEMBRANE.....	245
Cytosis.....	245
Endocytosis.....	245
Phagocytosis (cellular eating)	246
Pinocytosis (cellular drinking).....	246
Receptor mediated endocytosis	247
Exocytosis	247
SAMPLE QUESTIONS	248
REFERENCES	255

TOPIC 6: TRANSPORT IN LIVING ORGANISMS	256
Syllabus extract.....	256
Need for a transport system.....	258
BLOOD	259
ERYTHROCYTES (Red blood cells)	259
LEUCOCYTES (white blood cells)	260
BLOOD PLATELETS (thrombocytes)	261
TRANSPORT OF OXYGEN	262
Oxygen tension and oxyhaemoglobin formation	263
Effect of carbon dioxide on the oxygen dissociation curve (Bohr's effect).....	264
TRANSPORT OF CARBON DIOXIDE	270
VASCULAR SYSTEMS IN ANIMALS	271
MAMMALIAN BLOOD CIRCULATION	275
THE MAMMALIAN HEART	275
Initiation of the heart beat	276
Intrinsic control of the heart beat	279
Hormonal control of the heart rate.....	279
Control of the rate of the heart beat	279
BLOOD VESSELS	281
TOPIC 7: DEFENCE AGAINST DISEASES	286
Clotting of blood	286
Mechanism of immune responses.....	293
Cell mediated immune response.....	295
THE LYMPHATIC SYSTEM	300
Vaccines	301
BLOOD TRANSFUSION	301
RHESUS FACTOR (D-Antigens)	302
UPTAKE AND TRANSPORT IN PLANTS	304
TRANSPIRATION	304
STOMATA	310
LENTICELS	314
WATER UPTAKE BY THE ROOTS	315
Vascular tissues.....	318
THE UPTAKE OF WATER FROM THE ROOTS TO THE LEAVES	321
UPTAKE AND TRANSLOCATION OF MINERAL IONS	323
TRASLOCATION OF ORGANIC MOLECULES	326

SAMPLE QUESTIONS	331
Time days	334
REFERENCES	344
TOPIC 8: EVOLUTION	345
SYLLABUS EXTRACT	345
THEORIES FOR THE ORIGIN OF LIFE	346
THEORIES TO EXPLAIN THE MECHANISM OF EVOLUTION	346
DARWINISM	346
LAMARCKISM	347
NEODARWINISM (Modern synthetic theory of organic evolution)	348
EVIDENCE FOR EVOLUTION	349
COMPARATIVE EMBRYOLOGY	349
PALEONTOLOGY (The study of fossils)	350
CELL BIOLOGY	351
TAXONOMY (CLASSIFICATION)	351
COMPARATIVE ANATOMY	352
COMPARATIVE BIOCHEMISTRY AND PHYSIOLOGY	354
BIOGEOGRAPHY (SPECIES DISTRIBUTION/GEOGRAPHICAL ISOLATION)	355
INDUSTRIAL MELANISM	357
CROSS BREEDING/ ARTIFICIAL SELECTION	357
RESISTANCE TO DRUGS AND PESTICIDES	357
SELECTION	358
NATURAL SELECTION	358
ARTIFICIAL SELECTION	362
SEXUAL SELECTION	362
KIN AND GROUP SELECTION	363
SPECIATION	363
INTERSPECIFIC HYBRIDISATION	363
MECHANISM OF SPECIATION	364
EXTINCTION OF SPECIES	368
THE HARDY-WEINBERG PRINCIPLE	370
SAMPLE QUESTIONS	372
TOPIC 9: ECOLOGY	376
SYLLABUS EXTRACT	376
Introduction	378
2.0 CONCEPT OF THE ECOSYSTEM	381

B.O.D (Biological oxygen demand)	386
ECOLOGICAL SUCCESSIONS	389
Energy flow through an ecosystem	392
Energy budgets	394
ECOLOGICAL PYRAMIDS	395
BIOLOGICAL AND GEOCHEMICAL CYCLING (NUTRIENT CYCLING)	396
3.0 POPULATION AND NATURAL RESOURCES	400
Population growth	401
Population growth and survivorship curves	405
Determination of population size of organisms	407
4.0 INTERDEPENDENCE	412
Interaction within the populations	412
Competition	412
Predation	414
Parasitism	417
5.0 EFFECTS OF HUMAN ACTIVITIES ON ECOSYSTEMS	418
POLLUTION	418
Chemical pest control	424
NATURAL RESOURCES	427
Conservation of natural resource	430
SAMPLE QUESTIONS	430

TOPIC 1: LEVELS OF ORGANISATION AND DIVERSITY OF LIFE

Syllabus extract

Specific objectives: The learner should be able to;	Content
1.1 Diversity of living things	
<ul style="list-style-type: none"> Explain the principles of taxonomy. Explain the principles of classification. Explain the importance of studying diversity. List 3 criteria for classifying organism. State the hierarchy of classification according to Carl Linnaeus. 	<ul style="list-style-type: none"> Principles of taxonomy: identification, classification and nomenclature. Principles of classification: artificial and natural. Importance of studies on diversity. 3 criteria of classifying organisms: (morphology, anatomy, physiology) Hierarchy of classification according to Carl Linnaeus (kingdom-phylum/ division-class-order-family-genus-species). Binomial classification (scientific and local name).
1.2 Classification Practical	•
<ul style="list-style-type: none"> Distinguish between organisms using the binomial system of nomenclature. Construct simple biological keys. Explain the need to conserve biodiversity. 	<ul style="list-style-type: none"> Differences between organisms using the Binomial nomenclature. Construction of simple biological keys. Importance of conserving biodiversity.
1.3 Viruses (Akaryotae)	•
<ul style="list-style-type: none"> Draw and label a diagram to show the structure of a virus. Describe the general structure of a virus. Explain characteristics of viruses. Describe the economic importance of viruses. Suggest methods of preventing the spread of viral diseases. 	<ul style="list-style-type: none"> Structure of viruses Characteristics of viruses Economic importance of viruses Methods of preventing the spread of viral diseases.
1.4 Kingdom Monera	•
<ul style="list-style-type: none"> Differentiate between bacteria and viruses. Make a labeled diagram to show the structure of bacteria. Describe characteristics of bacteria. State the role of bacteria in the environment. 	<ul style="list-style-type: none"> Differences between bacteria and viruses. Structure of Bacteria. Characteristics of bacteria: shape, cell wall, reproduction, movements. Economic importance of bacteria in the environment.
1.5 Kingdom Monera. Practical	
<ol style="list-style-type: none"> Draw, label and state the types of bacteria. State the role of bacteria in the production of daily products. Name common bacterial diseases. Describe methods of preventing the common bacterial diseases. 	<ol style="list-style-type: none"> Types of bacteria. Role of bacteria in production of dairy products. Common bacterial diseases. Methods of preventing them.
1.6 Kingdom Protoctista	•
<ul style="list-style-type: none"> State characteristics of the Protoctista. Describe the structure of protozoa and Algae Outline the role of protozoa and Algae organisms in the environment. Name common diseases caused by protozoa Culture methods of preventing spread of diseases caused by protoctists. 	<ul style="list-style-type: none"> Characteristics of the Protoctista. Structure of Protozoa and Algae Economic importance of Protozoa and Algae, e.g. <i>Amoeba</i>, <i>Euglena</i>, <i>Entamoeba</i>, <i>Paramecium</i>, <i>Trypanosome</i>, <i>Plasmodium</i>. Common diseases caused by protozoa Methods to prevent spread of diseases caused by protozoa.
1.7 Kingdom Protoctista Practical	•
<ul style="list-style-type: none"> Prepare temporary mount of <i>Spirogyra</i> filaments. Draw and label structure of <i>Spirogyra</i> as seen under a light microscope Identify and draw protozoa from prepared slides. 	<ul style="list-style-type: none"> Structure of the spirogyra Characteristics and structure of protozoa
1.8 Kingdom Fungi Practical	•

<ul style="list-style-type: none"> • State characteristics of fungi. • State characteristics of <i>Rhizopus</i> of <i>Mucor</i>, yeast, and the mushroom. • State the economic importance of fungi • Name common fungal diseases. • Describe the methods of preventing the spread of fungal diseases. • Explain the use of yeast in brewing alcohol and bread making. 	<ul style="list-style-type: none"> • Characteristics of fungi (feeding, reproduction) • Characteristics of <i>Rhizopus</i> of <i>Mucor</i>, yeast, and the mushroom. • Economic importance of fungi. • Common fungal diseases. • Methods of preventing the spread of fungal diseases. • Use of yeast in brewing alcohol and bread making.
1.9 Kingdom Fungi Practical	•
<ul style="list-style-type: none"> • Prepare a temporary mount of yeast <i>Mucor</i>/<i>Rhizopus</i>. • Draw and label structure of <i>Rhizopus</i> or <i>Mucor</i>, yeast, and the mushroom. 	<ul style="list-style-type: none"> • Structure of yeast, <i>Mucor</i>/<i>Rhizopus</i> as seen under the light microscope. • Structure of the mushroom.
1.10 Kingdom Plantae	
<ul style="list-style-type: none"> • Identify lower plants and higher plants using structural features. • Name the plant divisions phyla • Outline briefly the characteristics and structures of the named plant domain/phyla • State the role of plants in the environment 	<ul style="list-style-type: none"> • Structural features of lower plants and higher plant. • Plant divisions/ phyla: Bryophyte and Pteridophyta (Ferns)/ Filicinophyta, Coniferophyta, Spermatophyte. • Characteristics and structures of named plant domain/ phyla, Bryophyte, Filicinophyta, Coniferophyta, Spermatophyte (gymnosperms and angiosperms to class level). • Economic importance of plants in the environment
1.11 Kingdom Plantae, Practical	•
<ul style="list-style-type: none"> • Identify distinguishing structural features of plant groups in lower plants. • Identify distinguishing structural features of plant groups in higher plants. 	<ul style="list-style-type: none"> • Structural features of lower plants; Bryophyta, pteridophytes/ Filicinophyta. • Structural features of: higher plants; Coniferophyta, Spermatophyta; (gymnosperms, angiosperms)
1.12 Kingdom Animalia	•
<ul style="list-style-type: none"> • State characteristics of invertebrates and vertebrates • State the distinguishing structural features of organisms in different animal phyla. • Explain the role of animals in the environment • Discuss the welfare of domestic and wild animals. 	<ul style="list-style-type: none"> • Characteristics of invertebrates and vertebrates. • Distinguishing structural features of the following phyla: <ul style="list-style-type: none"> - Porifera - Coelenterate/ Cnidaria - Platyhelminthes - Nematode - Annelid - Mollusca - Echinodermata - Arthropoda down to classes, Consider class insect down to order - Chordate down to vertebrate classes • Economic importance of the animal groups • Welfare of domestic animals (consider care and feeding) and wild animals (Mention protection and conservation).
1.12 Kingdom Animalia Practical	
<ol style="list-style-type: none"> 1 Classify phylum Arthropod to class level using structural features. 2 Identify structural features of class insecta to order level. 3 State distinguishing structural features of animals other than arthropods 	<ol style="list-style-type: none"> 1 Structural features of Arthropod organisms down to class level. 2 Structural features of other animals other than arthropods.

Classification is defined as the grouping of organisms together basing on the features they have in common.

Taxonomy is defined as the science of classification.

Branches of taxonomy

Nomenclature is the giving of names to organisms.

Systematics is the placing of organisms into groups basing on their similarities and differences.

Binomial nomenclature is the assigning of two Latin names to each organism. The first name/word is the *generic* name and the second name/word is the *specific* name.

In binomial nomenclature, the following rules are observed;

- i. The generic name starts with the upper case (capital) letter while the species name starts with a lower case (small) letter.
- ii. Unless written in italics, the two words must be underlined separately e.g. Homo sapiens/ *Homo sapiens*.

THE TAXONOMIC HIERARCHY

This is the descending order in size of the taxonomic group. The order is Kingdom, Phylum (division in plants), Class, Order, Family, Genus and Species.

Each taxonomic group is called a **taxon** or taxa (plural). Each taxon possess a **diagnostic feature** i.e. features which are unique (peculiar) to that group e.g. presence of the vertebral column is a diagnostic feature for phylum Chordata. Fur is a diagnostic feature for class mammalia and feathers are peculiar to birds.

What is a species? This is a group of organisms having many common physical and other features and if sexually reproducing, they can breed to produce fertile offsprings.

PRINCIPLES OF CLASSIFYING ORGANISMS

Artificial classification: this is based on one or a few easily observable characteristics for simplicity and convenience.

Natural classification: this considers natural relationships between organisms e.g. internal and external features. The features considered include;

- Embryology
- Physiology
- Biochemistry
- Cell structure
- Behavior

Phylogenetic classification: this is based on evolutionary history (phylogeny) of organisms. Organisms belonging to the same group are believed to share a common ancestor. It bases so much on fossil evidence.

Phonetic classification: this is based only on observable characteristics and all characters are considered to be of importance. A lot of data is

collected and the degree of similarity between different organisms is usually calculated by computers.

NOTE: classification today is mostly natural and phylogenetic.

IMPORTANCE OF STUDYING BIODIVERSITY

The survival of humanity depends upon properly functioning ecosystems to maintain drinkable water, breathable air and productive soils to grow food.

THE NEED TO CONSERVE BIODIVERSITY

1. **Food.** 75% of our food supply comes from just 12 plant species, and more than 90% of global livestock production comes from just 15 species of mammals and birds. That's deceptive, though, because those 27 species-along with many others that also provide food for humans couldn't exist without help from hundreds of thousands of lesser-known species working behind the scenes e.g. pollinators and wild relatives which are gene reserves for the domesticated plants and animals
2. **Health.** By having a diverse mix of plants, fungi and animals to eat, we ensure nutrition that buffers our bodies against diseases and other hardships.
3. **Ecosystem services.** These include **clean air** (oxygen from photosynthesis of forests as well as phytoplanktons, these absorb carbon dioxide), **clean water** (forests help soil absorb more water which reduces flooding, limits erosion, filter out contaminants and refill aquifers), **healthy soil** (many arthropods and microorganisms play important roles in maintain soil fertile), **raw materials** (biodiversity supplies a variety of materials from both wild and cultivated species).
4. **Resilience.** Biodiversity provides insurance, it allows for ecosystems to adjust to disturbances like extreme fires and floods.
5. Ethics, aesthetics and awe.

SPECIMEN IDENTIFICATION AND KEYS

A specimen key involves listing observable characteristics of organisms and matching them with those features which are diagnostic in a particular group.

The characteristics used in keys should be readily observable morphological characters. They may be qualitative e.g. shape or quantitative e.g. number of segments. The characteristics must be constant for that species and not subject to variations as a result of

environmental influence, colour and size are highly discouraged.

Dichotomous key

This is a simple diagnostic key in which pairs of statements called **leads**, each dealing with a particular characteristic is numbered e.g. 1, 2, 3, e.t.c. The paired statements of each lead should be contrasting and mutually exclusive. Such that by considering them in order, a large group of organisms is broken down into progressively smaller groups until the unknown organism is identified. An example of a dichotomous key for identifying arthropods is shown below,

- 1 a) Has 8 legs.....W
- b) Has 6 legs.....2
- 2 a) Has long antennae.....X
- b) Has short antennae.....3
- 3 a) Has proboscis.....Y
- b) Has mandibles.....Z

THE DOMAIN SYSTEM

The domain is the most inclusive taxonomic category; larger than a Kingdom. The three domains as proposed by Woese, are

- a. Bacteria, which includes kingdom Eubacteria
- b. Archaea, which includes Kingdom Archaeobacteria
- c. Eukarya, which includes Kingdom Protista, Fungi, Plantae and Animalia.

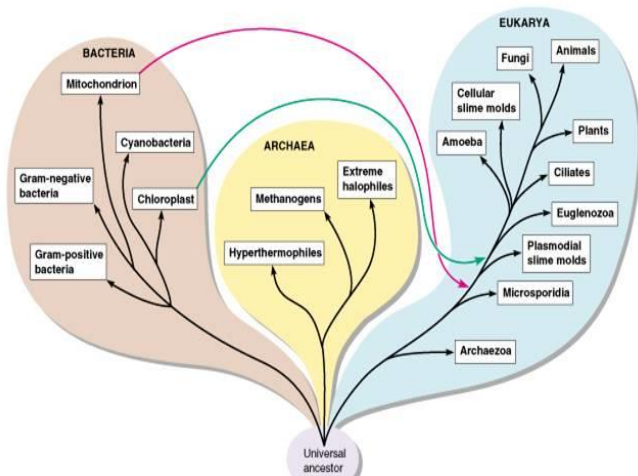

THE FIVE KINGDOMS

Kingdom Monera:

Eubacteria - new bacteria -Prokarya

Archaeobacteria – old bacteria

celled organisms- Eukarya

Kingdom Fungi- multicellular fungi/yeast-Eukarya

Kingdom Plantae- photosynthetic plants - Eukarya

Kingdom Animalia- animals from zygote-Eukarya

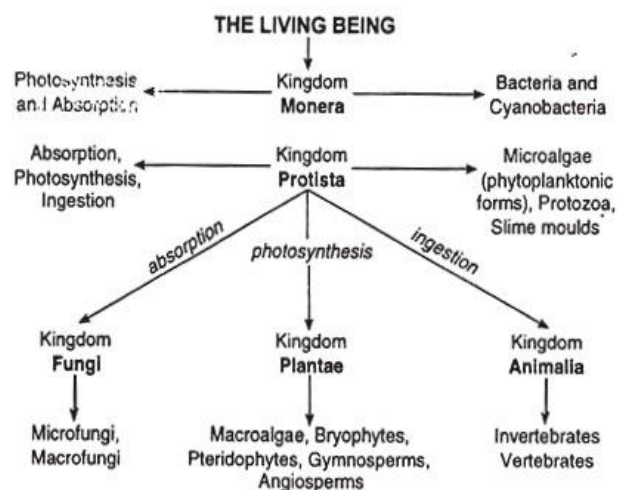

VIRUSES

Viruses do not fit in any of the above kingdoms because they are on the border of living and non-living things. Viruses have a simple structure consisting of a small piece of nucleic acid either DNA or RNA which in most viruses is surrounded by a protein or a lipoprotein.

Characteristics of viruses

- i. They lack a cellular structure i.e. they are acellular
- ii. They are the smallest living things 20-300nm in diameter
- iii. They are obligate endoparasites i.e. they can only live parasitically inside other cells.
- iv. They depend on host cells for reproduction
- v. Viruses are highly specific i.e. each virus recognises and infects a particular host.
- vi. Most viruses enter their hosts by phagocytosis and pinocytosis

Reasons why viruses are considered to be living things

- a. They possess genetic material
- b. They can mutate and hence evolve
- c. They carry out protein synthesis in host cells

- d. They are capable self-replication when inside host cells
- e. They can transmit characteristics to the next generation

Reasons why viruses are considered to be non-living things

- a. They can be crystallised
- b. They lack enzyme systems
- c. They cannot metabolise unless they are inside host cells
- d.

Generalised structure of a virus

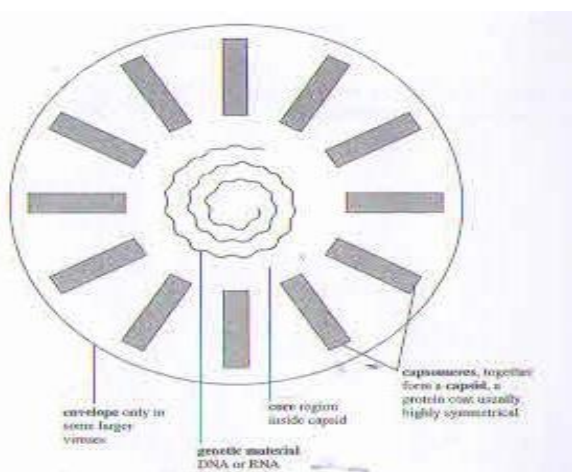

Core	This is the inner region in which the genetic material (DNA or RNA) is found. The DNA or RNA may be single stranded or double stranded
Capsid	This is the protective coat of protein surrounding the core. The Capsid is made up of subunits called capsomeres.
Envelop	This is found only in some large viruses

Structure of HIV

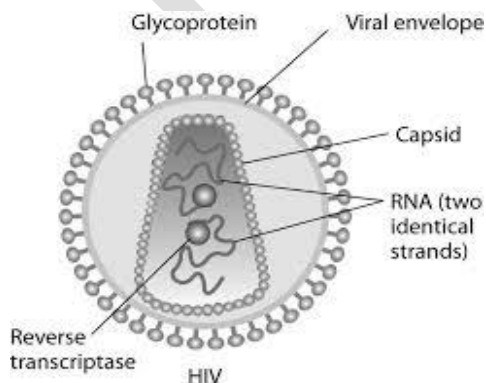

HIV is spherical and about 1000nm in diameter. The core region contains 2 molecules of single stranded RNA and reverse transcriptase enzyme surrounded by a cone shaped protein capsid. The capsid is enclosed by an envelope composed of a lipid and glycoprotein.

The reverse transcriptase enzyme converts single stranded RNA into double stranded DNA copies. HIV is referred to as a **retrovirus** because the enzyme reverse transcriptase, found in retroviruses, catalyses the conversion of viral RNA into DNA i.e. reverse transcription. The viral DNA made is then inserted into the host's DNA where it directs the production of more viral properties.

The envelope contains glycoproteins which bind specifically to help T-cell receptors, enabling the virus to enter the helper T-lymphocytes.

Examples of viral diseases;

- a. In plants
 - i. Cassava mosaic disease
 - ii. Tobacco mosaic disease
 - iii. Tomato bush stunt disease
 - iv. Southern bean mosaic disease
- b. In animals
 - i. Small pox
 - ii. The Acquired Immuno Deficiency Syndrome (AIDS)
 - iii. Rabies
 - iv. Measles
 - v. New castle disease

Economic importance of viruses

Useful roles

1. **In preparing antidotes/ vaccine:** Pox, mumps, polio, jaundice e.t.c. diseases can be controlled by penetrating using or dead virus in human body as vaccines
2. **In controlling harmful animals and insects:** Some animals and insects which are harmful for humans can be controlled by some special virus
3. **Control of disease:** T2 bacteriophage virus saves humans from dysentery by spoiling some harmful bacteria, like, e-coli.
4. **In laboratory:** Virus is used in lab, as the simplest living model. In the research of genetics virus used. It is an important subject in genetic engineering.
5. **In the evidence of evolution:** Virus plays a vital role to acquire knowledge about the trend of evolution and the process of formation of living organisms because virus contains both living and non-living characteristics.

Harmful roles:

6. Virus destroys plenty of bacteria useful for humans. Different diseases like common Cold, Influenza, Mumps, Pox, Polio, Yellow fever, Harpies, Aids etc. are caused by the attack of virus.

State the ways of spreading viral diseases

- 1.
- 2.

Methods of preventing spread of viral diseases

1. Vaccination: Vaccines are not available for all viruses. For those that there are, public policy decisions must be made as to whether at-risk populations are targeted or whether universal vaccination is pursued.
2. Hygiene and Sanitation: Proper waste water treatment is important in keeping viruses out of the water supply since virus contamination in sewage is between 10^3 and 10^4 particles per liter.
3. Vector control: Mosquito control is often more effective than vaccination given the sporadic nature of most arboviral (arthropod-borne) diseases.
4. Lifestyle changes: For diseases transmitted sexually and by intravenous drug use, lifestyle change should change transmission patterns if it can be implemented.
5. Eradication:

Not all viral disease are eradicable. The necessary features for eradication are:

- An effective vaccine that optimally doesn't require a cold chain and is easily administered
- No animal reservoir
- Lack of recurrent infection
- One or a few stable serotypes
- No infectivity before symptoms and no unapparent infections, making early containment possible

KINGDOM PROKARYOTAE/MONERA

Prokaryotes are organisms whose genetic material is not bound by a nuclear membrane.

All members are unicellular and they belong to two main groups;

a. Archaea

This group contains organisms that grow under extreme conditions e.g. halophiles which grow under extremely high salt concentration

b. Hyperthermophiles

This group contains organisms that grow under very high temperatures.

BACTERIA

They are the smallest unicellular organisms and they are the most abundant.

Generalised structure of a bacteria

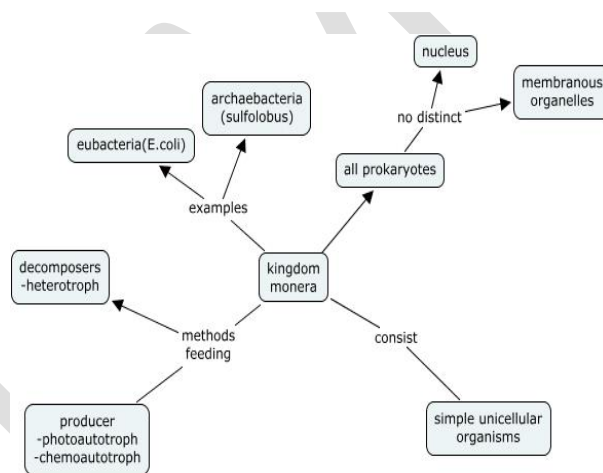
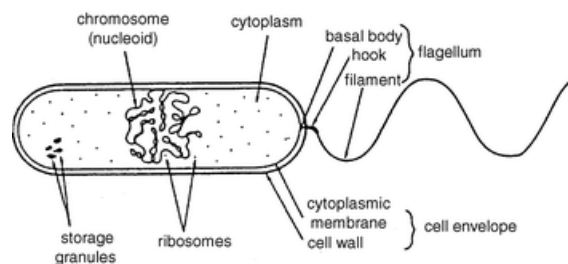

CLASSIFICATION OF BACTERIA

This is based on structural and metabolic features.

Classification by shape

There are four main shapes of bacteria and they are as follows;

a. Spherical shape (cocci, singular = coccus)

They may be clusters e.g. *Staphylococcus aureus* which causes boils and food poisoning.

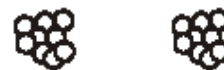

They may occur in pairs enclosed by a capsule, diplococci e.g. *Diplococcus pneumoniae* which causes pneumonia.



They may occur in chains, streptococci e.g. *Streptococcus thermopiles* which gives yoghurt the creamy flavor



b. Rod shaped (bacilli, singular = bacillus)

They may occur as single rods e.g. *Escherichia coli* which lives in the guts of humans and *Bacillus anthrax* which causes anthrax.



They may occur in chains e.g. *Azotobacter* which fixes nitrogen in the soil.

**c. Curved or spiral shaped**

Spiral shaped bacteria include *Spirillum* species



Curved shaped bacteria include the comma shaped (vibrios) bacteria such as *Vibrio cholera* which causes cholera.

**d. Filamentous bacteria**

This group includes *Actinomyces* which occur in the mouth and may cause dental caries.

Classification by method of respiration**a. Aerobic bacteria**

These bacteria require oxygen for respiration. Obligate aerobes cannot survive without oxygen but facultative aerobic bacteria can survive in the absence of oxygen.

b. Anaerobic bacteria

They respire without oxygen and obligate anaerobes are killed in the presence of oxygen. Facultative anaerobic bacteria can use oxygen but can respire without it.

Classification by methods of nutrition**a. Autotrophic bacteria**

These bacteria manufacture their own organic food from carbon dioxide.

Photoautotrophic (photosynthetic) bacteria use energy of sun light to convert carbon dioxide into carbohydrates. Examples include; the blue-green bacteria, sulphur bacteria and cyano bacteria.

Chemoautotrophic (chemosynthetic) bacteria use energy from chemical reactions to convert carbon dioxide into carbohydrates. Inorganic substances such as ammonia, methane and hydrogen sulphide are oxidized to release energy.

Examples include;

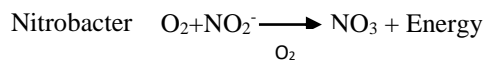
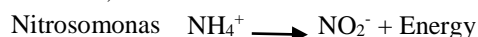
**b. Heterotrophic bacteria**

They feed on already made organic food but in different ways.

Chemo-heterotrophic bacteria obtain energy from chemicals in food.

Saprotrophic bacteria obtain their food from dead and decayed organic matter.

Such bacteria secrete enzymes into the food, and absorb the soluble products of extra cellular digestion with the saprotrophic body for assimilation.

Parasitic bacteria live on other organisms (hosts) from which they obtain food as the host suffers harm.

Mutualistic bacteria live in close associations with other organisms e.g. in the root nodules of legumes

Note: *Escherichia coli* contribute vitamins B and K groups. *Rhizobium* fixes nitrogen into the plants as it is provided with a shelter.

Classification by staining reaction

Gram positive bacteria; they stain purple with a gram stain. The cell wall has an extra outer membrane made up of lipopolysaccharides.

Gram negative bacteria; they stain pink with a gram stain. Their cell wall lacks an extra outer membrane which is made out of lipids and polysaccharides. The outer membrane gives them protection against penicillin and lysozymes.

ECONOMIC IMPORTANCE OF BACTERIA

1. They are cultured for research purposes e.g. genetics studies
2. They facilitate the making of foods like yoghurt, cheese and vinegar
3. They are used for making antibiotics, amino acids and enzymes.
4. In humans, vitamin K and B complex are produced by the symbiotic bacteria (*E. Coli*) while in animals it is used to break down cellulose.
5. They cause decomposition of dead organic matter, hence enabling their disposal.
6. They take part in nutrient recycling e.g. the nitrogen cycle, carbon cycle and the phosphorous cycle.
7. On the other hand, bacteria cause food to get spoilt
8. Bacteria like *Thiobacillus* and *Disulphovibrio* produces sulphuric acid which destroys underground metal pipes.

9. Manufacturing processes e.g. making soap powders, tanning leather, making linen.

Examples of bacterial diseases

- 1.
- 2.
- 3.

Methods of preventing common bacterial diseases

- 1.
- 2.
- 3.

Differences between bacteria and viruses

Viruses	Bacteria
They are very small (ultra-microscopic)	They are larger in size as compared to viruses (microscopic)
Non-cellular (acellular)	Single-celled
Have no metabolism of their own	Have metabolism of their own
Do not grow and do not divide	Grow in size and divide to produce more bacteria
Take no food by any method	Take food by adsorption
Command the host cell to reproduce virus	Can reproduce by their own
Can be crystallised	Cannot be crystallised
All produce diseases in man, animals or plants	Some are harmless, some useful and some are disease causing
Either DNA or RNA is present in virus body	Both DNA and RNA present in bacteria body
Virus is a true parasite	Bacteria is parasite of saprophytic or photosynthetic

KINGDOM PROTISTA

Protists are eukaryotes and they may be unicellular or multicellular. They are placed under several phyla but those of much importance at this level include the following.

PHYLUM RHIZOPODA

Examples include;

- i. *Amoeba proteus* which lives in fresh water
- ii. *Entamoeba histolytica* which causes amoebic dysentery

Characteristics

- They are unicellular and bear pseudopodia (false feet) which enables movement and phagocytosis
- They reproduce asexually
- They feed heterotrophically
-

Diagram of Amoeba

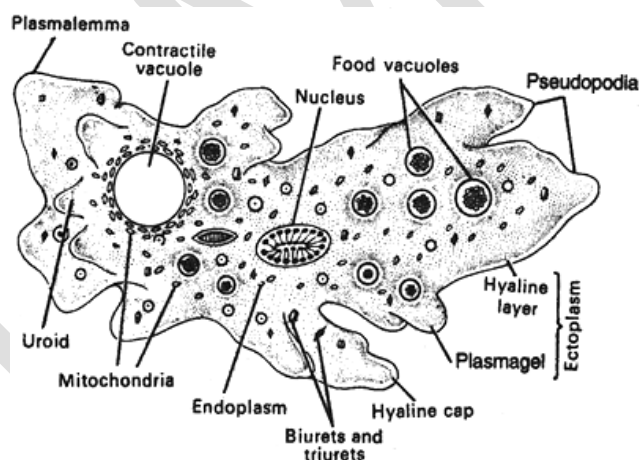

Structure of Amoeba proteus

Functions of the parts

The **mitochondria** is used in the production of energy for the contractile vacuole

The **cytoplasm** is the place where all the important chemical reactions take place.

The **contractile vacuole** is used for osmoregulation

The **nucleus** is essential for directing activities

PHYLUM CILIOPHORA (CILIATES)

Examples include Paramecium, Stentor, Vorticella, Didinia e.t.c.

Characteristics

- They are unicellular
- They feed heterotrophically
- Their cilia has a 9+2 tubule arrangement
- The cilia collects food and enable locomotion in water
- Their habitat is fresh water and marine water

- They have two types of nuclei, the larger macro nucleus which controls all cell metabolic activities and the micro nucleus which controls sexual reproduction called conjugation.
- The macro nucleus is polyploid i.e. it has more than two sets of chromosomes and the micro nucleus is diploid i.e. it has two sets of chromosomes.

Diagram of a paramecium

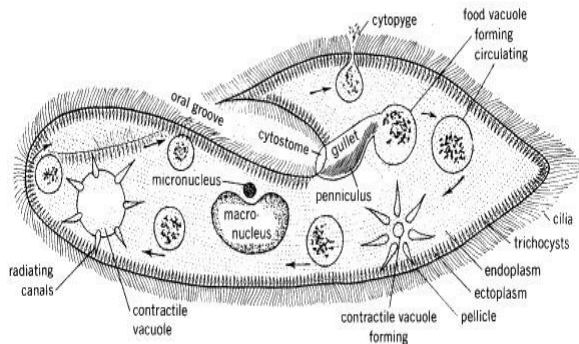

PHYLUM ZOOMASTIGINA (Flagellates)

Examples include trypanasoma which causes trypanosomiasis (sleeping sickness), trychomonas

Characteristics

- They bear flagella for locomotion
- They are heterotrophic
- They are unicellular
- They reproduce both asexually and sexually
- They bear a 9+2 tubule arrangement
-

PHYLUM EUGLENOPHYTA

The only member is euglena which lives in an aquatic environment.

Characteristics

- They are mostly unicellular
- They reproduce asexually
- They move by flagella
- Some are photosynthetic while others are heterotrophic or autotrophic

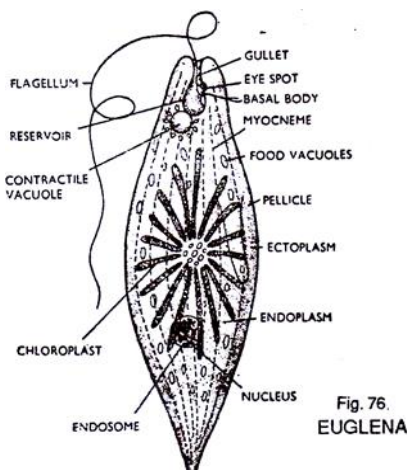

PHYLUM APICOMPLEXA (sporozoans)

Members include plasmodium which causes malaria in humans

Characteristics

- they are unicellular
- they are heterotrophic
- they lack locomotory structures
- they are spore producing parasites of animals
- they reproduce sexually and asexually
- their lifecycles are complex involving several animal hosts

Life cycle of plasmodium

An infected anopheles mosquito bites a person, injecting plasmodium sporozoites in its saliva. The sporozoites enter the person's liver cells. After several days, the sporozoites undergo multiple divisions and become merozoites, which use the apical complex to penetrate red blood cells. The merozoites divide asexually inside the red blood cells. At intervals of 48 or 72 hours (depending on the species), large numbers of merozoites break out of the blood cells, causing periodic chills and fever. Some of the merozoites infect other red blood cells. Some merozoites form gametocytes. Another anopheles mosquito bites the infected person and picks up plasmodium gametocytes along with blood.

Gametes form from the gametocytes; each male gametocyte produces several slender male gametes. Fertilisation occurs in the mosquito's digestive tract, and a zygote forms. An oocyst develops from the zygote in the wall of the mosquito's gut. The oocyst releases thousands of sporozoites, which migrate to the mosquito's salivary glands.

PHYLUM CHLOROPHYTA (green algae)

The members include volvox, chlorella and spirogyra

Chlorella which is a unicellular non filamentous alga that lives in fresh water ponds

Chlamydomonas which is a motile unicellular algae

Characteristics

- They contain chlorophyll and therefore they are photosynthetic
- Their cell walls contain cellulose
- They store starch
- They reproduce sexually and asexually
- Spirogyra is a filamentous algae that lives in fresh water ponds

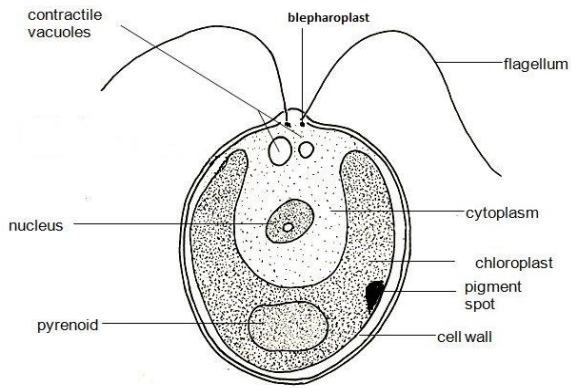

Chlamydomonas

Spirogyra is a filamentous algae that lives in fresh water ponds

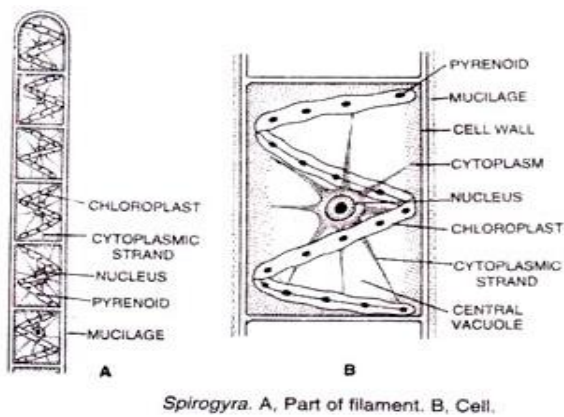

Spirogyra. A, Part of filament. B, Cell.

PHYLUM PHAEOPHYTA

These are the brown algae. The members include Fucus, Laminaria and Ascophyllum.

Characteristics

- They possess chlorophyll and therefore carry out photosynthesis
- They are multicellular
- They are marine and are therefore called the sea weed
- They contain a brown pigment called fucoxanthin which gives them a brown colour

PHYLUM RHODOPHYTA

These are red algae and members include Chlorella.

Characteristics

- It is marine
- It contains chlorophyll hence it carries out photosynthesis
- It contains a red pigment called phycoerythrin
- It also contains a blue pigment called phycocyanin

- It produces agar which is extracted from them for laboratory purposes

PHYLUM OOMYCOTA

Includes peronospora which grows on grapes and pythium which causes late potato blight and tomato rot

They are characterized by production of spores that bear flagella. Such spores are produced both sexually and asexually.

These are referred to as the lower fungi

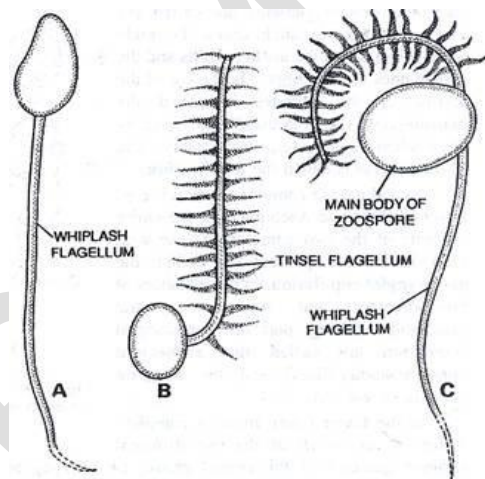

Fig. 8.16. Zoospores. A, posteriorly uniflagellate with a whiplash flagellum; B, anteriorly uniflagellate with a tinsel flagellum; C, biflagellate with an anterior tinsel and posterior whiplash flagellum.

ECONOMIC IMPORTANCE OF ALGAE

1. They can be used as fertilisers in farms
2. They carry out photosynthesis in oceans which:
 - Provide food for other organisms
 - Release oxygen
 - Reduce carbon dioxide which would cause acidity in water
3. Some of their products are useful in various industrial processes
4. Algae blooms result in severe pollution of water bodies.
5. Chlorella can be cultivated to provide Single Cell Protein (SCP) for humans and animal consumption

KINGDOM FUNGI

Characteristics that distinguish them from plants

- Carbohydrates are stored as glycogen but not as starch
- Their cell walls contain chitin but not cellulose
- They have no chlorophyll hence they don't carry out photosynthesis

- They reproduce by spores that lack flagella
- They carry out heterotrophic nutrition as parasites and saprophytes on microorganisms.
- Their bodies are usually made up of a mycelium of thread like multi nucleate hyphae without distinct cell bodies (aseptate) or they may have cross walls (septate)
- They undergo nuclear mitosis i.e. their cytoplasm, nuclear membrane and cell membrane never divided
- Fungal mitochondria have flattened cristae (whereas plants have tubular ones)

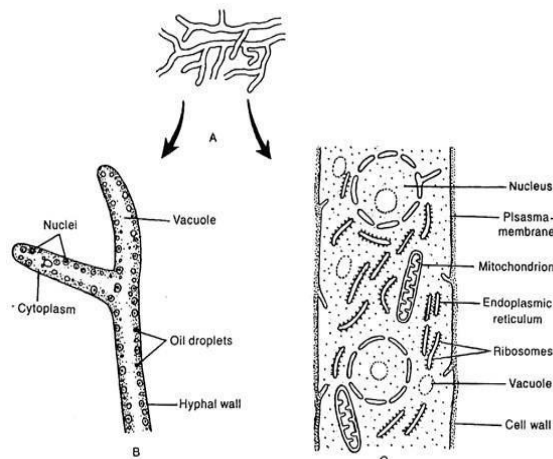
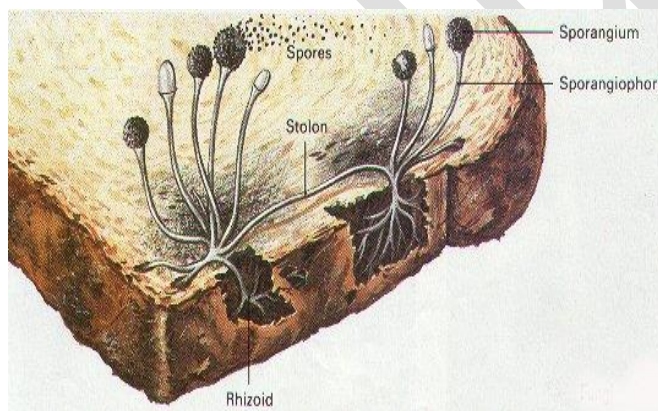

Fig. 4.27 : *Mucor* : A. Vegetative mycelium, B. Portion of hypha under light microscope, C. Portion of hypha under electron microscope

PHYLUM ZYCOMYCOTA

Members include mucor and rhizopus (bread mould). They live in damp organic matter e.g. bread



Note;

- The sporangium is black when ripe and colourless when immature. It produces spores for asexual reproduction
- The sporangiophore is a vertically growing hypha that bears the sporangium.
- Rhizoids which are root like structures

PHYLUM ASCOMYCOTA

Members include Penicillium, Aspergillus and Yeast sacchromycetes.

Characteristics

- Penicillium species form blue; some are green or sometimes yellow moulds on bread, decaying fruit e.t.c.
- Their hyphae have cross walls called septa, therefore Penicillium is septate
- It reproduces asexually by means of spores called conidia formed at the tip of special hyphae called conidiophores.
- Penicillium produces penicillin which is an antibiotic, during aerobic respiration.

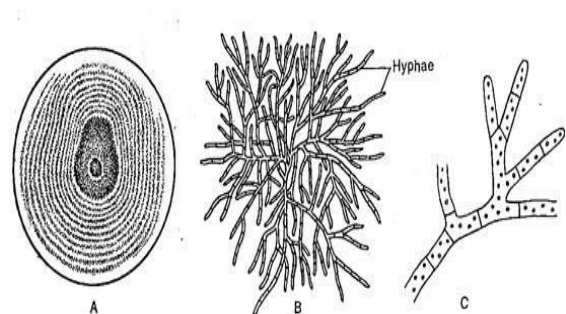
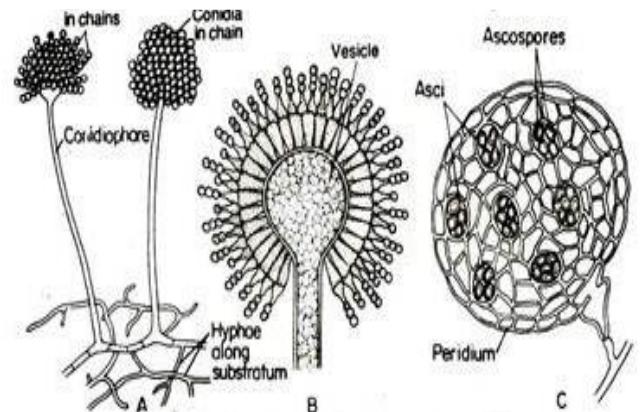

Fig. 4.42 : *Penicillium* : A. A colony, B. Mycelium of *Penicillium*, C. Mycelium, enlarged view



Aspergillus Sp.: A - Conidia on conidiophore, C - Ascocarp.

Characteristics of the yeast cell

- It has oval shaped cells
- It is unicellular
- Reproduces by budding
- Yeast produces ethanol during anaerobic respiration

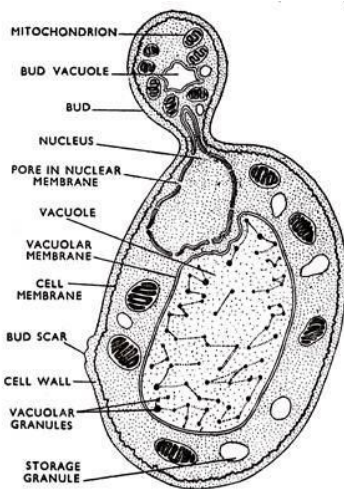
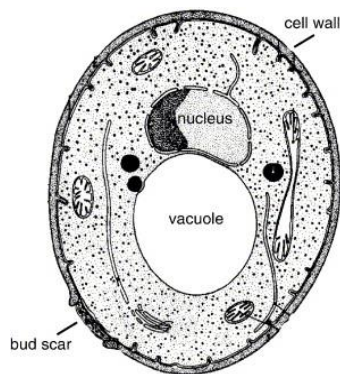

Fig. 215. *Saccharomyces cerevisiae*. Sectional view of a budding cell.

PHYLUM BASIDIOMYCOTA

Members include mushrooms, toad stools, puff balls and rusts. Rusts attack cereal crops

Characteristics

- They reproduce asexually by sporulation
- They have septate hyphae
-

ECONOMIC IMPORTANCE OF FUNGI

1. They cause decomposition of sewage and organic material in soil
2. Penicillium and Aspergillus form antibiotics during aerobic respiration
3. Yeast forms alcohol during anaerobic respiration
4. Yeast is used in bread production
5. Fermentation of Aspergillus forms citric acid used in lemonade formation
6. Used for experimental purposes especially in genetic investigations

7. Fungi causes decomposition of stored food and deterioration of natural materials like leather
8. Some fungi cause plant diseases e.g. powdery mildew caused by *Erysphiegraminae*
9. Some are poisonous to man
10. They cause skin irritations e.g. ringworms
11. They are eaten as food e.g. mushrooms

KINGDOM PLANTAE (plants)

Characteristics

- Their cell walls contain cellulose
- They reproduce both sexually and asexually
- They are multi cellular
- They are photosynthetic except for some parasites that lack chlorophyll
- They have alternation of generations i.e. the haploid and diploid generations alternate in the lifecycle.

PHYLUM BRYOPHYTA (bryophytes)

The members include mosses and liverworts. The members live in damp shady soils or tree logs.

Bryophytes are the smallest land plants and they are thought to have evolved from green algae.

Characteristics

- They lack vascular tissues
- They lack true roots, stems or leaves
- Their body is a **thallus** which is differentiated into simple "leaves and stems"
- Alternation of generation occurs and the gametophyte generation is dominant
- The gametophyte is anchored by thallus rhizoids which grow from the stem.

NOTE: Water and mineral salts are absorbed by the whole plant surface because the plant surface lacks a cuticle; therefore water uptake occurs by **osmosis**.

Phylum bryophyta contains two main classes;

1. Class hepaticae (liverworts)
2. Class Musci (mosses)

EXTERNAL FEATRES OF A MOSS

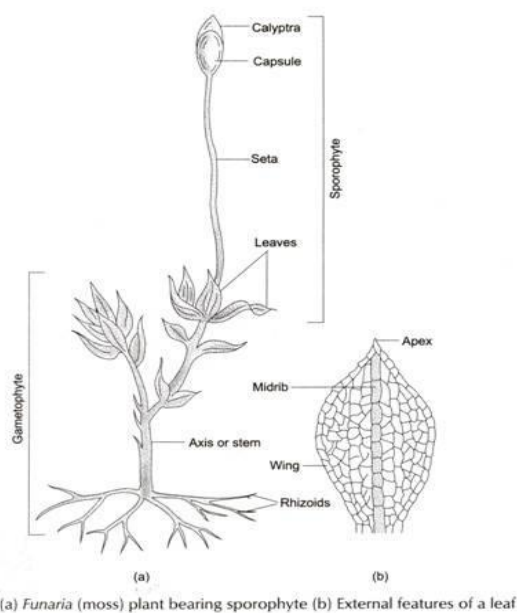

When mature, the antheridia shade their sperms (antherozoids) into the archegonia aided by the rain-splash.

The haploid biflagellate sperms fuse with haploid eggs (ospheres) to form a diploid zygote (oospheres)

The zygote develops into sporophytes which attach and survive on the gametophyte

When mature, the sporophyte produces haploid spores by meiosis. The spores are released by splitting of the spore capsule when dry.

When the spores land on moisten soils, they germinate into a protonema which later develops into a new diploid gametophyte

ALTERNATION OF GENERATION

This is the occurance of two or more generations within the lifecycle of an organism, a haploid gametophyte and a diploid sporophyte.

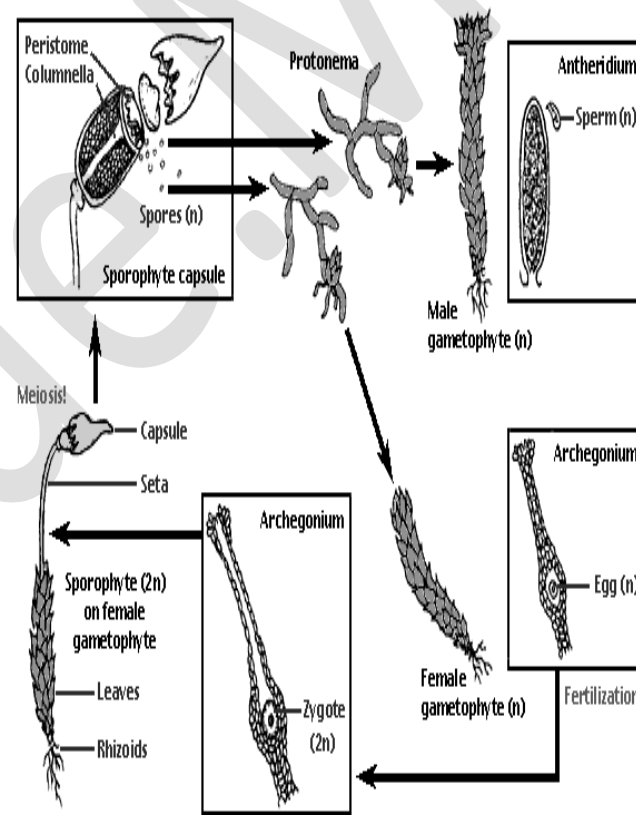
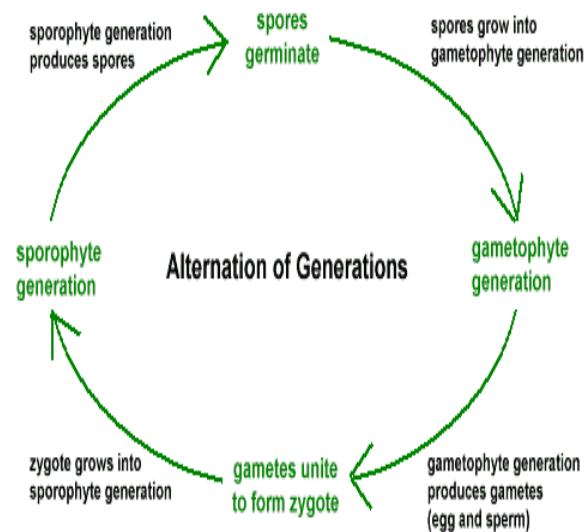

Description of alternation of generation in a bryophyte like a moss

A moss consists of two distinct forms in its lifecycle i.e. the haploid gametophyte which is dominant and the diploid sporophyte

The antheridia (sperm producing organ) and archegonia (egg producing organ) may be located on the same plant or different plants.

PHYLUM PTERIDOPHYTA (Filicinophyta or the ferns)

Members include; Pteridium and Dryopteris

Characteristics

- The vascular tissue (xylem and phloem) are present.
- The leaves are relatively large and are called fronds. The large surface area of the leaves increases the photosynthetic surface of the plant

- Spores are produced in sporangia (singular; sporangium), usually in clusters called sori (sorus, singular)
- Alternation of generation occurs and the sporophyte is dominant
- The gametophyte is reduced to a small simple prothallus
- The sporophyte generation posses true roots, stems and leaves.

The roots penetrate the soil to absorb water and dissolved mineral salts

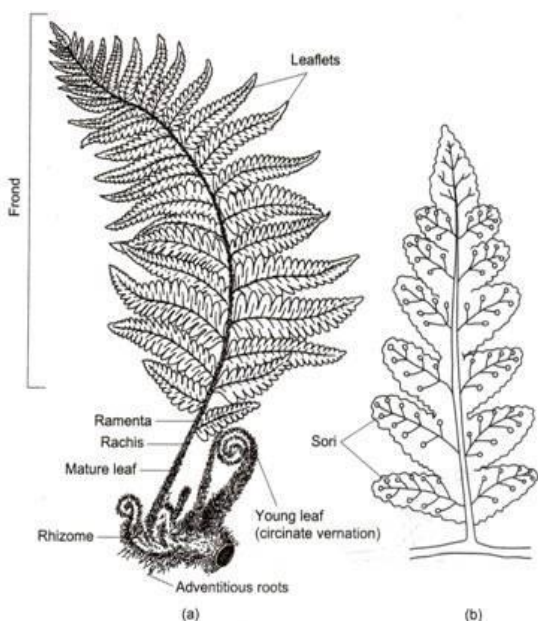

(a) External features of *Dryopteris* (fern) (b) Ventral view of a pinna showing sori

ALTERNATION OF GENERATIONS IN A FERN (Pteridophyte/filicinophyte)

A fern consists of two distinct forms in its life. The diploid sporophyte, which is the dominant stage and the haploid gametophyte

- The diploid spore (mother cell) inside the sporangia divide
- When mature, the protecting covering (indusium), shrinks and catapults the spores of the sporangia
- The spores germinate into a heart-shaped prothallus which is the gametophyte
- Prothallus bears antheridia which produces haploid sperms and archegonia which produces eggs by mitosis

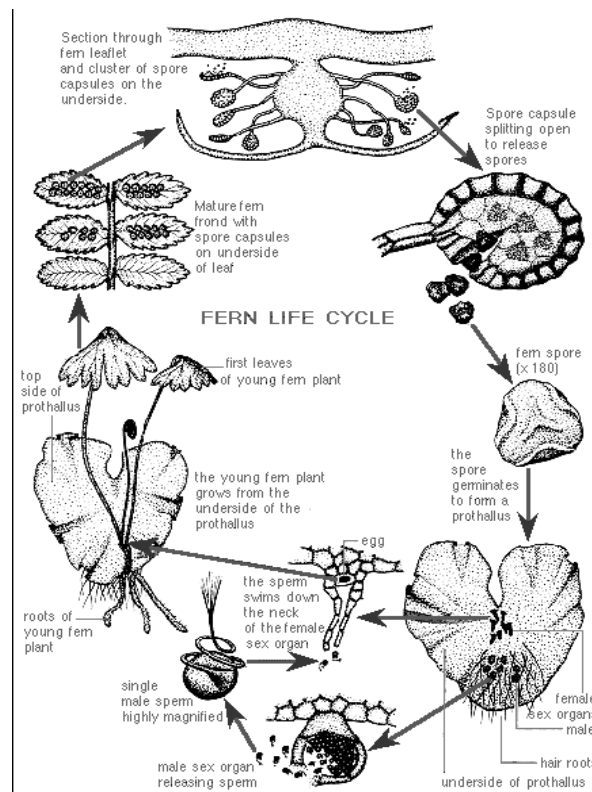

- On rupturing, the ciliated sperms from the antheridia swim towards the fertile eggs in the archegonia
- The zygotes develops into sporophytes

COMPARISON BETWEEN A MOSS AND A FERN

Similarities

- Both form spores
- Both grow in damp soils/ organic matter
- Alternation of generation occurs in both
- In both the gametophyte is anchored by the rhizoids

Differences

Moss	Fern
No vascular tissue	Vascular tissue present
No sorus	Sorus present at leaf underside
Spore capsule present	No spore capsule
Saprophyte is attached to gametophyte	Gametophyte is attached to sporophyte
It lacks true roots, leaves and stems	True roots, stems and leaves are present

Rhizoids present	No rhizoid
Gametophyte not heart shaped	Gametophyte is heart shaped
Leaves are simple and small	Leaves are relatively large

COMPARISON OF ALTERNATION OF GENERATION BETWEEN MOSSES AND FERNS

Similarities

- Spore formation occurs in spore bearing sporangia
- Sporophytes are diploid while gametophytes are haploid
- Spores form by meiosis whereas gametes are formed by mitosis
- Sexual and asexual reproduction occurs
- Male gametes are motile while eggs are non-motile
- In both there's only one dominant stage
- The gametophyte bears the archegonia
- Sperms formed in the antheridia are brought into contact with the eggs by some mechanism

Differences

Moss	Ferns
The sperms are biflagellate	The sperms are ciliated
Sporophytes grow on the gametophyte	Sporophyte is self-supporting
Spores germinate into a protonema first and then into a gametophyte	Spores germinate directly into a gametophyte
Gametophyte is a dominant generation	Saprophyte is a dominant generation
There is much dependency on water for growth, spore dispersal and gamete transfer	There is less dependency on water, only being used for gamete transfer and spore germination
Gametophytes may or may not bear both sexual reproductive organs	Gametophytes always bears both sexual reproductive organs

SIGNIFICANCE OF ALTERNATION OF GENERATION

1. Spores cause rapid multiplication of species
2. Different habitats of the ecosystem are exploited by the different generations
3. It enables plants to cope with adverse environmental conditions
4. Reduces chances of extinction
5. Gametes are formed by meiosis which brings about genetic variations

PHYLUM CONIFEROPHYTA

Members include Cedars, Horches and Christmas tress i.e. Firs and Spruce

Characteristics

- They bear cones in which spore producing sporangia and seeds develop
- They lack fruits and flowers
- The seed is naked i.e. it is not enclosed by the ovary wall.
- Leaves are usually needle-like with a thick waxy cuticle

Economic importance

1. A source of soft wood for timber
2. Pine nuts are used in cooking
3. Spruce and firs are used as Christmas trees

PHYLUM ANGIOSPERMOPHYTA

This phylum includes all flowering plants

Characteristics

- They flowers in which sporangia, spores and seeds develop
- The seeds are enclosed in an ovary
- After fertilisation, the ovary develops into a fruit
- There are two classes of Angiospermatophyta
 - Monocotyledon
 - Dicotyledon

Monocots	Dicots
Embryo sac has one seed leaf (cotyledon)	Embryo sac has two seed leaves (cotyledons)
Have scattered vascular bundles in the stem	Have a ring of vascular bundles in the stem

Flower parts are usually in 3's or multiples of 3	Flower parts are usually in 4's or 5's or multiples of 4 or 5
Calyx and corolla are not usually easily distinguishable	Calyx and corolla are easily distinguishable
They are usually wind pollinated	They are often insect pollinated
Have narrow leaves with parallel venation	Have broad leaves with network venation

Comparison between conifers and angiosperms.

Similarities

1. Both bear seeds
2. Sporophyte generation is dominant
- 3.

Differences

Angiosperms	Conifers
Have flowers and	Do not have flowers
Produce seeds enclosed within a carpel	Seeds unprotected by an ovary or fruit
Leaves are flat	Leaves are scale-like
Xylem contains vessels	Xylem only contains tracheids, but not vessels
Phloem contains sieve tubes with companion cells	Phloem does not contain sieve tubes with companion cells
Both male and female reproductive structures occur in the flower	Reproductive structures occur in the cones
Flowers can be unisexual or bisexual	Cones are always unisexual
Ovules are covered by the ovary	Ovules are attached to the megasporophylls
Do not produce archegonia	Have archegonia
Sperms do not contain flagella	Sperms have flagella
Under go double fertilisation	Do not under double fertilisation
Endosperm and plant body are triploid	Endosperm and plant body are haploid
Seeds are covered by a fruit	Seeds are naked

Challenges or problems faced by plants

1. Desiccation/ dry out
2. Support in air/ on land
3. Obtaining nutrients

4. Obtaining gases for respiration
5. Movement of the reproductive gametes
6. Environmental variables such as light intensity, temperature, pH e.t.c.

Summary of adaptations of seed bearing plants to life on land

1. Leaves possess stomata for gaseous exchange
2. Leaves and stems are covered by a waxy cuticle which minimises water loss
3. They possess true roots which enable water and dissolved mineral salts to be absorbed
4. They undergo secondary growth which enable seed bearing plants to compete effectively for light and other resources
5. The fertilised ovule (seed) is retained for sometime on the parent plant (sporophyte) from which it obtains protection and food before dispersal.
6. Fertilisation is not dependent on water therefore reduces necessity for water inside the sporophyte which is well adapted for terrestrial life.

The adaptations above may also be considered as the advantages of seed bearing plants over mosses and ferns

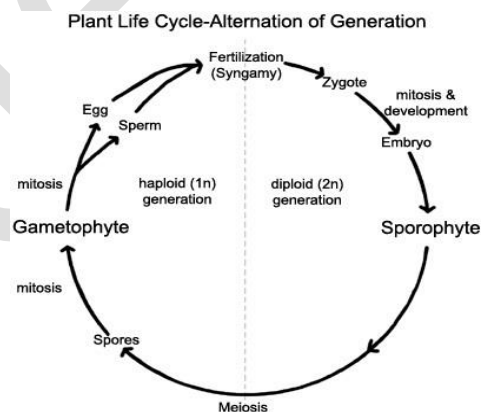

Economic importance of plants in the environment

1. Unlike animals, plants synthesize their own food via **photosynthesis**, which uses carbon dioxide and water to form carbohydrates with the help of sunlight and releases oxygen and energy into the environment, thereby becoming the source of oxygen that animals and humans breathe in to sustain life.
 - Humans and other living things on earth depend on plants for their food and energy.
 - Plants along with the help of bacteria and other organisms to fix the minerals and inorganic elements as foods, hence known as primary producers.
 - Primary herbivores that feed on plants incorporate the food into their body.
 - Carnivores (secondary consumers) feed on these primary consumers.

• Some carnivores feed on these secondary consumers and become tertiary consumers.

2. Food Production/Agriculture

Most of the foods that we consume are plant products only: e.g. wheat, rice, corn, vegetables, nuts, oils, beverages, and fruits. Agriculture also forms a way of earning money for farmers.

3. Plants in Industry

Several industrial products are derivatives of plants: hemp, cotton, linen, rubber, furniture, paper pulp, and components to be used in other industries such as tannin in leather industry; essential oils in soaps, perfumes, and shampoos; and lubricants for automotive industry.

4. Plants as Medicines

Since ancient era, plants have been used in the medicinal field to cure various diseases and conditions, and still, it is increasing. Herbs form the major sources of medicinal compounds in pharmaceutical industries.

5. Plant Fossils as Fuel

Even the plant fossils are used by humans as source of fuels: coal and petroleum.

The economic importance of plants is almost found in every aspect of the planet and other living things. Destruction of plants leads to ecological imbalance and in turn survival of any organism on the planet. Hence, saving the existing trees and planting more trees are vital for the very existence of living organisms and protecting the environment.

KINGDOM ANIMALIA

General characteristics

- Their cells lack cell walls
- Most can move from one place to another i.e. they are motile
- They are multicellular eukaryotes
- They have a nervous common system except the sponges

Definition of terms

1. Tissue

This is a group of cells, often similar in structure and origin, operating together to perform a specific function

2. Tissue differentiation

This is the specialisation of tissue for different functions

3. An organ

This is the structural distinct part of the body which usually performs a particular function.

An organ is made up of similar types of tissue which are highly organised and have structural relationship with each other.

4. Organism

This is the interrelationship of different organ systems which together perform a specific function

5. Symmetrical body

This is the body which when cut, may produce halves which are mirror (identical) images of each other.

Bilateral symmetrical body

This is the body which can be divided into two identical halves along one plane only.

Radial symmetrical body

This is the body which can be cut along more than one plane to produce halves that are identical to each other.

6. Asymmetrical body

This is a body which cannot produce halves that are mirror images of each other if cut along any plane.

LEVELS OF ORGANISATION

Four levels of organisation are recognised;

1. Unicellular level (single cell organisation)

Protists have all the functions which are carried out by an organ system being performed by a single organelle in the cell. Such organisms include paramecium, amoeba plasmodium e.t.c.

2. Tissue level of organisation

These are primitive multicellular animals in which physiological processes are carried out mainly by isolated cells and tissues. Apart from reproductive organs, there are no structures that can be regarded as organs but most of the cells are integrated to form tissues.

Such animals represent a stage in evolution preceding the development of organs and organisms which are the characteristics of higher forms.

Tissue level is considered to be between the colonial and unicellular levels of organisation.

Tissue level of organisation includes animals such as hydra.

3. Colonial level of organisation

These organisms have different types of cells each carrying out a different function. They are therefore regarded as colonies of single cells rather than multicellular individuals e.g. sponges

4. Organ level of organisation

Plants, mammals and the majority of animals have their functions carried out mostly by organ and organs systems

Advantages and disadvantages of unicellular level of organisation

Advantages

1. Their small size enables living in a variety of habitats
2. There is less food intake

- There is no need for the development of complex excretory organs since they take in less food.
- No necessity for development of complex circulatory and gaseous exchange structures since simple diffusion combines with their large surface area to volume ratio
- There's no need for development of complex support systems like cartilage, bones, xylem e.t.c.

Disadvantages

- Predators

Advantages and disadvantages of multicellular level of organisation

Advantages

- Worn out cells are easily replaced by cell division
- Multicellularity allows tissue specialisation which increases efficiency in performing body functions
- They have complex physiological mechanisms which enable the maintenance of a relative constant internal environment
- They have a larger complex support system which increase the chances of catching prey but also reduces chances of predation
- They have an efficient sensory system due to tissue specialisation which enables animals to escape from predators quickly.

Disadvantages

- They require large quantities of food
- They require specialised locomotory structures to enable motion
- They produce a large quantity of waste products hence a necessity for development of complex excretory systems
- They have a small surface area to volume ratio that requires development of transport systems since simple diffusion cannot supply enough nutrients to the animal

PHYLUM CNIDARIA (Cnidarians)

Members include Hydra, Obelia, sea anemone, Portuguese man of war and Jelly fish.

Characteristics

- They are **diploblastic animals** i.e. they have two cell layers separated by the mesogloea (a Jelly-like non-cellular layer)

The mesogloea may contain cells that have migrated from other layers.

Transverse section through the body of Cnidarians

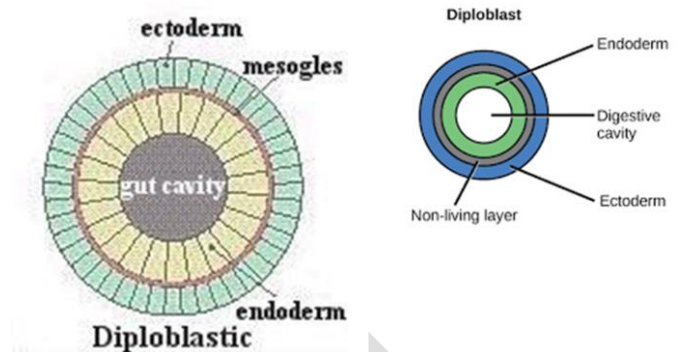

- They have nematoblasts (stinging cells) which when touched (stimulated) release a chemical which can be used to capture prey or used to defend against predators

Nematoblasts occur in the ectoderm and when touched, can inject toxins into the prey/ predator which results into paralysis of the small animals.

The structure of a body wall of hydra

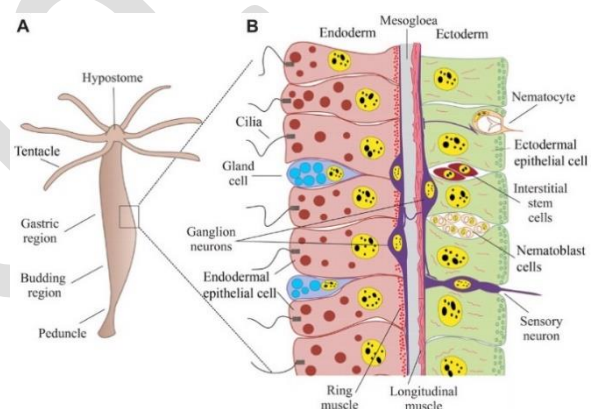

- They are radially symmetrical i.e. the body can be divided into equal halves by more than one straight line/plane which passes through the central body
- They exhibit polymorphism i.e. individual cells have specialised shapes with different functions

Polymorphism is the existence of the cell organisms in a number of morphologically distinct forms.

- They have tentacles which bear stinging cells called nematoblasts

Hydra belongs to the tissue level of organisation which enables cells to act together in a relatively coordinated manner so as to carry out various functions effectively.

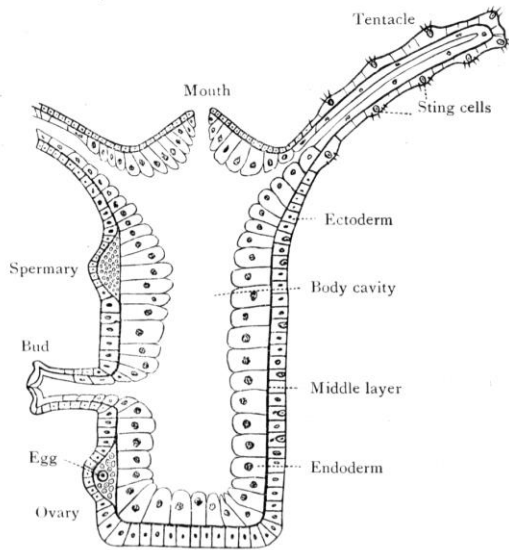

PHYLUM PLATYHELMINTHES

Members include tapeworm (*Taenia solium* and *Taenia Saginata*), blood fluke (*Schistosoma*), liver fluke (*Fasciola hepatica*) and planaria which causes Schistosomiasis (Bilharzia) in tropical countries,

Characteristics

- They are Triploblastic i.e. the body is composed of three layers, the outer ectoderm and the inner endoderm and between these two is the mesoderm

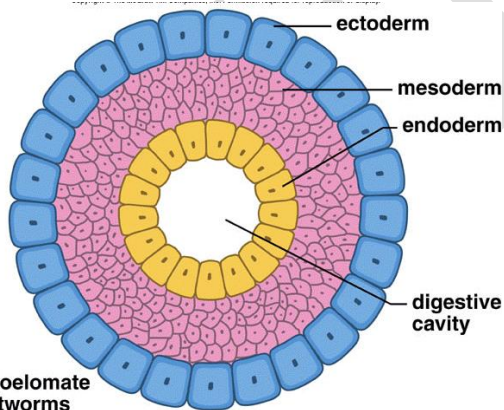

a. Acoelomate flatworms

- They have bilateral symmetry i.e. The body can only give two equal and opposite halves if cut along one plane.
- They have an un-segmented body
- Their bodies are dorsal ventrally flattened
- They are hermaphrodites, often with elaborate precautions to minimise self fertilisation
- They have flame cells for excretion and osmoregulation

Significance or importance of possessing a mesoderm in the body

1. It allows triploblastic organisms to increase in size and thus results into the considerable separation of the alimentary canal from the body wall
2. Used in forming a variety of organs which may combine together and contribute towards an organ system of organisation
3. It enables the improvement of muscular activity by triploblastic organisms. It's necessary because of their increased size which renders the use of flagella or cilia inappropriate.

ADAPTATIONS OF PLATYHELMINTHES TO A PARASITIC MODE OF LIFE

1. They have a special way of gaining entry into the body of the host but locomotory structures are generally reduced or absent.
2. They have structures which anchor them onto their host. Liver flukes have suckers; tapeworms have both hooks and suckers.

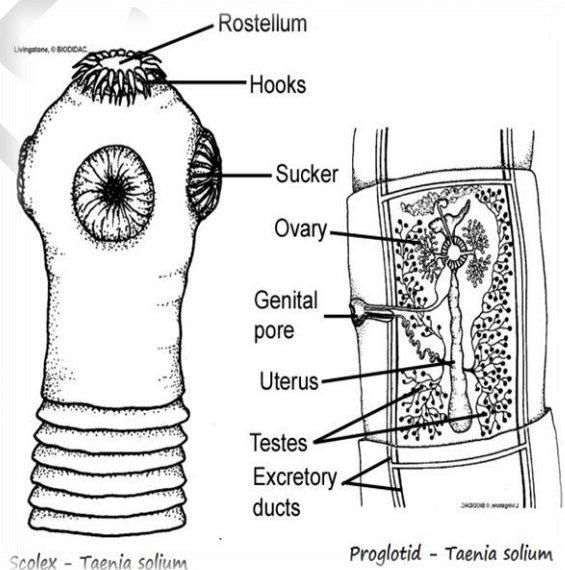

3. They protect themselves against the internal environment. Flatworms produce inhibitory substances to prevent their being digested by host enzymes.
4. They have complex lifecycles. Fasciola and Taenia have a secondary host which transfers one parasite from the primary host to another.
5. They have a very high reproductive output. Adults devote much of their energy and body space to sexual reproduction.

PHYLUM NEMATODA (round worms)

Members include;

- Ascaris Lumbricoides*, which is an intestinal parasite
- Wuchereria bancrofti*, which infects the human lymphatic system and causes elephantiasis
- Thread worms* which are endoparasites of dogs and cats plus humans, mainly children.

Characteristic features

- They are triploblastic
- They have bilateral symmetry
- They have an un-segmented cylindrical body
- Their alimentary canal is straight from the mouth to the anus.
- Their sexes are separate
- They lack cilia
- A cuticle of protein is present
- Some are free living plant and animal parasites
- They are elongated and round in cross-section with pointed ends

PHYLUM ANNELIDA

(segmented worms)

General characteristics

- They are coelomate and triploblastic
- They have no Chitinous cuticle
- They possess Chitinous bristles called *chaetae*
- They exhibit *metameric segmentation* i.e. their segments are repeated and are of the same age and size
- They have bilateral symmetry

Examples include *Lumbricus* and *Hirudo* the medicinal leech

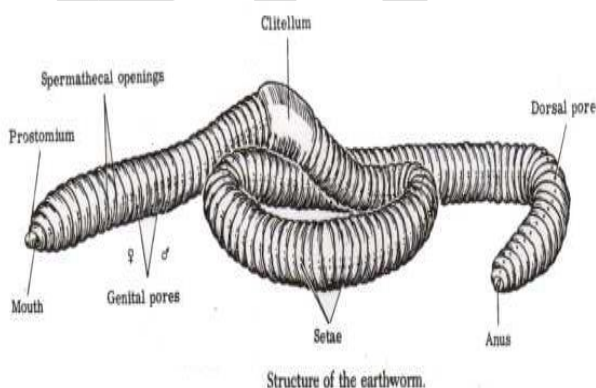

Biological importance of earthworms

1. They mix soil layers

2. They burrow tunnels which improves aeration and drainage of the soil
3. They add organic matter to soil by excretion and death
4. Secretions of the gut neutralise acidic soils
5. Dead vegetation is pulled into the soil where decay takes place

THE COELOM

This is the main (secondary) body cavity of many triploblastic animals, in which the gut is suspended. The principal mode of origin is by separation of the mesoderm from the endoderm. It contains a fluid (coelomic fluid) which receives excretory wastes and/gametes, which reach the exterior via ciliated funnels and ducts.

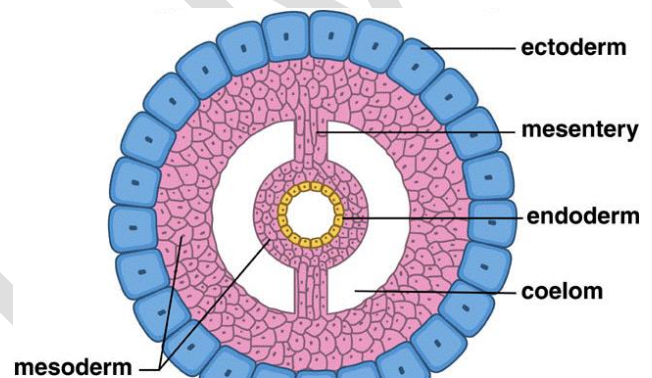

- c. Coelomate molluscs annelids arthropods echinoderms chordates

Biological significance of the coelom

1. It provides space in which internal organs can grow, develop and function independently of each other
2. It contains coelomic fluid which bathes the organs and can act as a hydrostatic skeleton
3. It allows the animal's internal organs to move independent of each other and move independent of the whole body e.g. the gut can perform peristalsis without causing the body wall to move into waves of contraction
4. Coelomic fluid may be used to circulate food, waste materials and respiratory gases although these functions are mainly carried out by the body vascular system.
- 5.

Problems caused by the coelom

- i. It separates the body wall from the gut, causing difficulty in transporting digested food and respiratory gases resulting into the development of transport system

- ii. Increased size and complexity requires a more complex coordination system, therefore a more elaborate nervous system

PHYLUM MOLLUSCA

Characteristics

- These are triploblastic coelomate animals
 - They have soft bodies which are covered by a calcareous shell i.e. shell containing calcium. These shells are produced by special epidermal tissue called *mantle*
 - They have an un-segmented body with a head, foot with a visceral hump is a central mass of internal organs
 - They have bilateral symmetry
- Members include slugs and *Helix* (the garden snail), mussels, oysters, clams, squids, octopus and cat fish.

PHYLUM ECHINODERMATA

Examples include starfish, sea cucumbers, sea lilies, brittle stars and sea urchins.

Characteristics

- Their skin bears spines hence the name of the phylum
- Adults show penta-radial symmetry (5-way symmetry) but their larval forms show bilateral symmetry
- The mouth generally occurs on the lower side (oral side) while the anus occurs on the upper side (lateral side)

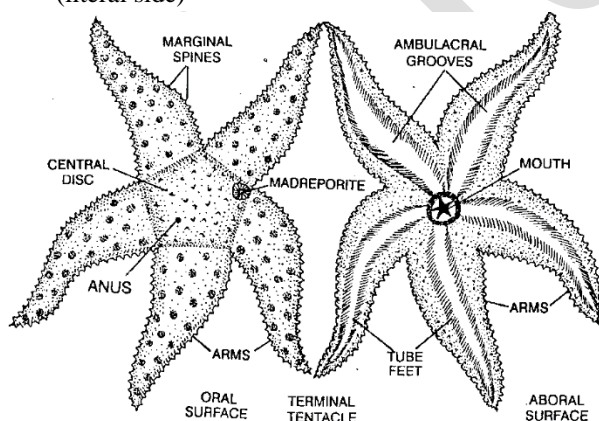

- They lack a proper circulatory system
- They are exclusively marine inhabitants
- They have a calcareous skeleton
- They move slowly by the concerted action of numerous suctional tube feet
-

PHYLUM ARTHROPODA

Arthropods contain more species than any other phyla. Insects in particular, account for more than half of all known arthropods. Insects have been successful in exploiting every type of habitat because they have undergone adaptive radiation i.e. they suited for flying, burrowing, living in aquatic areas, parasitism e.t.c.

Diagnostic features of arthropods

Possession of jointed appendages for feeding, locomotion and sensory purposes

Possession of an exoskeleton comprising of a chitinous cuticle and sometimes calcareous matter which makes it rigid and stiff at the mouth parts but flexible at the joints

Other characteristic features

- Triploblastic coelomate
- Bilateral symmetry
- Metameric segmentation
- The coelom is much reduced and the main body cavity is a haemocoel i.e. the coelom is almost completely displaced during development by another cavity called the haemocoel which is filled with blood

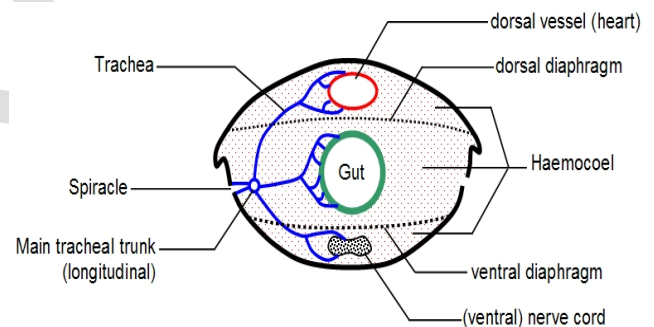

Transverse section of insect abdomen
(Showing tracheal system on left-side only)

NOTE

- Arthropods are at a high danger of blood loss from injury because they have the open blood system
- The high blood volume in arthropods enables them to maintain a high metabolic rate allowing them to be very active animals

Disadvantages associated with the presence of an exoskeleton

1. It's weight to strength ratio decreases with the size of the animal making it less efficient as the animals becomes larger

2. It resists growth and therefore periodical moulting (ecdysis) is required if the animal is to grow
3. During moulting, the body of the arthropod is soft and very vulnerable to attack by predators and pathogens

The groups of arthropods include;

Class Crustacea/ crustaceans

Members in this phylum include; Lobsters, Barnacles, Water fleas, Daphnia, and Astacus

Barnacles are sessile and remain attached to rocks by the head. Wood lice are the only terrestrial crustacean.

Characteristics

- Two pairs of antennae
- A pair of compound eyes
- Gaseous exchange occurs by gills
- Three pairs of mouth parts (jaws)
- They are mainly aquatic
- Head and thorax are not distinctively separate i.e. they possess a cephalothorax

Class Chilopoda

This class has Lithobius, (the centipede)

- Terrestrial and mainly carnivorous
- Have a clearly defined head, but all other body parts are similar
- They possess one pair of antennae
- They possess one pair of mouth parts (jaws)
- Eyes, either simple or compound, are absent
- Numerous identical legs i.e. one pair per segment
- No larval form
- Gaseous exchange occurs by the trachea

Class Diplopoda

The only member of this class is the millipede.

Characteristics

- Mainly terrestrial
- Mainly herbivorous
- The head is distinct but all other body segments are similar
- One pair of mouth parts
- One pair of antennae
- Eyes, either simple or compound, are absent
- Numerous identical legs with two pairs per segment
- They lack a larval form
- Gaseous exchange is by the trachea

Class Arachnida

Members include mites, ticks, scorpions, spiders (Epeira, the web spinning spiders) e.t.c.

Characteristics

- Mainly terrestrial
- Mainly carnivorous
- Two major body divisions present i.e. a cephalothorax and abdomen
- No antennae
- No true mouth parts but a pair of appendages are used for capturing prey and the second pair is used as sensory palps.
- Simple eyes present but no compound eyes
- Four pairs of walking legs
- No larval form
- Gaseous exchange is by lungs or gill books or trachea

Class Insecta

Diagnostic features

- a. Three main body divisions i.e. head, thorax and abdomen
- b. Three pairs of legs on the thorax, one pair per segment
- c. Three thoracic segments i.e. prothorax, mesothorax and metathorax.

Other characteristic features

- Mainly terrestrial
- No gills in adults
- They have simple eyes
- Usually three pairs of mouth parts
- Gaseous exchange occurs by trachea
- Lifecycles commonly involves metamorphosis

Subclass Apterygota, these are wingless insects and they include Lepisma (silverfish) a common inhabitant of bathrooms and kitchens

Subclass Pterygota, these are winged insects which are further divided into two;

a. Exopterygota

This is whereby the wings develop externally.

They undergo incomplete metamorphosis i.e.

Hemimetabolus

Examples include;

- Locusta (the long horned grass hopper)
- Periplaneta (cockroach)
- Dragon flies

b. Endopterygota

The wings develop internally.

They undergo complete metamorphosis i.e. holometabolus

Egg → larva → pupa → adult

The larval stage is specialised for eating and growing. They are known by such names as caterpillars and grub. The adult is specialised for dispersal and reproduction. Examples include;

- Pieris (butterfly)
- Apis (honey bee)
- Musca (housefly)

Some orders of class insecta

Order Orthoptera

Examples include crickets, grasshoppers and walking sticks.

Characteristics

- Chewing mouth parts
- Straight wings
- Complete metamorphosis
- Two pairs of wings with the front wings being narrow and leathery. The hind wings are broad, membranous and folded when at rest

Order Dictyoptera

Examples include cockroaches and mantids and their characteristics include;

- They are dorso ventrally flattened
- They undergo incomplete metamorphosis
- Two pairs of wings with the front wings being narrow and leathery. The hind wings are broad, membranous and folded when at rest.

Order Isoptera

Members include termites and their characteristics include;

- Chewing mouth parts
- Workers and soldiers are wingless
- They undergo incomplete metamorphosis
- Reproductive termites possess two pairs of similar membranous wings which are held out flat when at rest and the wings are shed off after the mating

Order Hemiptera

It includes all the bugs, and their characteristics include;

- Piercing and sucking mouthparts
- Two pairs of membranous wings

Order Homoptera

It includes aphids and cicadas. Their characteristics include the following;

- They have piercing and sucking mouth parts
- Incomplete or complete metamorphosis
- Some species can reproduce without mating
- Some are wingless, others possess one or two pairs of membranous wings

Order Hymenoptera

Members include ants, wasps, bees and sawflies. Their characteristics include;

- Chewing and lapping mouth parts
- Worker ants and few others are wingless
- Two pairs of small stiff and membranous wings that interlock during flight
- The front wings are larger than the hind wings
- They undergo complete metamorphosis

Order Lepidoptera

Members include butterflies and moth.

- Long antennae
- Complete metamorphosis
- Sucking mouth parts shaped like a coiled tube when at rest
- The front wings are usually larger than the hind wings
- Possess to pairs of usually broad wings which possess scales

Order Diptera

Members include houseflies, mosquitoes and midges. Their adult characteristics include;

- Two large compound eyes
- Piercing mouth parts
- Complete metamorphosis
- The two front wings are transparent and the two hind wings are reduced to halteres which serve as balancing organs during flight

Order Siphonoptera

This order includes the fleas and their characteristics include;

- They are wingless
- They lack eyes
- They exhibit incomplete metamorphosis
- They possess piercing mouthparts

Order Odonata

Members include dragon flies and damsel flies. Their adult characteristics include;

- Chewing mouthparts
- Two pairs of equal sized transparent membranous wings that cannot be folded.
- They have huge eyes
- They possess very small antennae
- Legs cannot walk but are used to capture prey in air
- They mate in flight
- They exhibit incomplete metamorphosis

PHYLUM CHORDATA

During their lifetime, all chordates possess the following structures;

1. Notochord

This is a rigid but flexible dorsal rod which consists of vacuolated cells surrounded by a tough outer coat. In primitive chordates, a notochord prevents shortening of the body so that most of the force of muscle contractions is transmitted into bending movements, which are useful for swimming.

2. Hollow dorsal nerve cord (central nervous system)

This is formed by invaginations from the outer wall layer (ectoderm) of the embryo and develops as a group of cells which is later closed off at the top.

3. Pharyngeal gill slits (visceral clefts)

These are perforations on either side of the pharynx which occurs in all chordate embryos.

In vertebrates, the number of slits is greatly reduced and may be modified for different purposes. For example, in fish and larval amphibians, their walls are lined with feathery gills which are used for gaseous exchange. In reptiles, birds and mammals, the only opening which remains is the Eustachian tube in the ear. In primitive chordates, visceral clefts are retained for straining food particles from water.

Other features possessed by my most but not all chordates include;

4. **Post anal tail** i.e. a post anal extension of the body or a true tail
5. **Segmented muscle blocks** (myotomes) which are considered as a secondary adaptation for swimming.
6. **Closed circulatory system** in which blood flows forward ventrally and backwards dorsally

Phylum Chordata is divided into two main groups

a. Acraniata

These are chordates without a skull and the notochord remains i.e. it is not replaced by a vertebral column. Acraniates are sub-divided into two;

Tunicata (urochordata)

Members of this subphylum include the sea squid and its characteristics include;

- The notochord is present
- The adult tunicates are sessile filter feeders which are enclosed in a tunic.

Cephalochordata

Members of this phylum include amphioxus and its characteristics include;

- The larvae are free swimming
- The adults possess a pharynx which is modified for filter feeding
- The notochord persists

b. Craniata (vertebrata)

These are chordates with a cranium (skull) enclosing the brain. The notochord is replaced by a vertebral column made of cartilage/bone.

They have two pairs of limbs/fins.

They have a well-developed central nervous system

Vertebrates are subdivided into the following taxa.

Subphylum Agnatha i.e. craniates without jaws or jawless fishes

Class cyclostomata

Members include Lampreys and Hag fish. Their characteristics include;

- No paired fins
- Semi ectoparasites i.e. they attach onto the body of fish, sucking on the fish's blood.
- They have numerous gills
- They have round suctorial mouthparts and a rasping tongue
- They have a well-developed notochord in adults.

Subphylum Gnathostomata i.e. craniates with jaws. It includes all the following classes.

Class chondrichthyes

Examples of members of this phylum include dog fish, skates, rays and sharks. Their characteristics include;

- The skin bears placid scales (tooth-like scales)
- The skin contains dermal denticles i.e. tooth-like structures with a central pulp cavity surrounded by an outer covering of enamel
- Pectoral and pelvic fins are paired

- Visceral clefts are present as separate gill openings (5 pairs)
- The anus is ventrally positioned
- They are poikilothermic
- They are marine dwellers.
- The tail is heterocercal i.e. the dorsal lobe of the tail fin is usually larger than the ventral lobe and this enables balancing since a swim bladder is lacking
- They have a cartilaginous skeleton

Class osteichthyes

Members include tilapia, perch and the herring. Their characteristics include;

- Bony endo skeleton
- Mouth is terminal
- Visceral clefts present i.e. separate gill openings (4 pairs) but covered by a bony flap called operculum
- The skin bears a cycloid and others ctenoid scales
- Fertilisation is external
- The tail is homocercal
- They are poikilothermic
- The swim bladder is present
- Some are marine while others are fresh water dwellers

Class crossopterygota

It includes the lung fish.

- They have paired fins
- They are mostly predators
- They live mostly in fresh water

Class amphibia

Members include Bufo (toad), Rana (frog), newts and salamanders. Their characteristics include;

- Partly aquatic and partly terrestrial
- Have simple sac-like lungs
- Have a soft moist skin used as a supplementary gaseous exchange surface
- They have two pairs of pentadactyl limbs
- Breeding occurs in water i.e. fertilisation is external
- They are poikilothermic
- Visceral clefts (gills) are present in aquatic larvae and gills are present in adults
- Newts and salamanders possess tails in adults and in the larva stage but frogs and toads possess the tail in the larva form only.

Class reptilia

Members of this class include alligators, crocodiles, snakes and reptiles.

- They exhibit internal fertilisation
- They have a bony endo skeleton
- They have a dry scaly skin with horny scales
- They are poikilothermic
- They have soft shelled eggs
- They are mostly terrestrial
- Gaseous exchange occurs by lungs
- They lay a cleidoic (shelled egg)

Class aves

This class includes all birds and their characteristics include;

- The skin bears feathers
- Their legs bear scales
- Fore limbs modified into wings
- They exhibit internal fertilisation
- They lay well developed cleidoic eggs
- They are homeothermic
- They possess lungs for gaseous exchange

Class mammalia

The characteristics for the members of this class include;

- Having mammary glands
- Possession of a pinna (external ear)
- They are endothermic or homeothermic
- Fertilisation is internal
- The skin bears fur with two types of glands i.e. the sebaceous glands and the mammary glands
- They are mostly viviparous i.e. they give birth to active young ones rather than laying eggs

Subclass prototheria

It includes all egg laying mammals e.g. the spiny anteater and the duck billed platypus. They lay large yoked eggs but like other mammals, their young ones suckle.

Subclass theria

These are non-egg laying mammals which are divided into groups;

a. Meta-theria/marsupial mammals

These are mammals which have pouches in which the young ones are located and suckle for most of their development, having been born in a very immature state e.g. kangaroo

b. Eutheria/placental mammals

These are mammals whose young ones develop to mature ones while in the womb or placenta before they are born. Examples include humans

Some orders of class mammalia include;

1. Order insectivora which includes moles and shrews
2. Order carnivora which includes cats and dogs.
3. Order cetacea which includes dolphins and whales
4. Order chiroptera which includes bats
5. Order rodentia which includes rats
6. Order primate which includes chimpanzee, humans, monkeys, apes and lemurs.
7. Order proboscidea which includes the elephant
8. Order ungulate which includes cattle, sheep, horses and goats.

Problems faced by animals living on land

- i. Obtaining support
- ii. Water loss
- iii. Gaseous exchange
- iv. Homeostasis
- v. How to reproduce without water

Adaptations of animals to live on land

1. Oxygen being less soluble and more plentiful in air than in water has led to the animals developing moist gaseous exchange surface coupled with breathing mechanisms e.g. lungs in invertebrates
2. To avoid desiccation, various animals have developed different mechanisms e.g. amphibians are restricted to damp habitats. Reptiles, birds, mammals and insects have a water tight surface layer which enables them to inhabit dry areas. Reptiles and birds produce a semi-solid nitrogenous waste containing uric acid which requires less water.
3. Internal fertilisation and production of shelled eggs in reptiles and internal development in mammals enables them to conserve water and become fully terrestrial. Amphibians have failed to overcome the problem of reproducing on land as they keep reverting to water for egg laying to prevent them from drying.
4. Air provides very little supply to terrestrial animals because of its low density as compared with water which has a high density. These animals have developed skeletons for support in air and muscular mechanisms for locomotion.

Amphibians, reptiles, birds and mammals have strong muscles and they are tetrapods (four limbed animals) with limbs built on the pentadactyl. This enables the

body to be lifted off the ground and propel the animal forward.

5. A variation in environmental conditions, most especially temperature has been overcome completely only by birds and mammals by evolving homeothermy i.e. they generate heat within their tissues physiologically and maintain a constant body temperature independent of external conditions. This provides optimum conditions for enzyme reaction and proper brain development. All other remaining terrestrial animals are poikilothermic and regulate their body temperature by bathing in the sun e.g. reptiles

Sample questions

1. Figure 1 below shows three types of organisms (not drawn to the same scale)

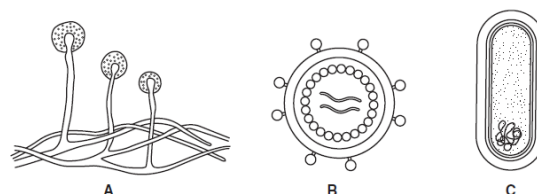

- a) Identify the three types of organism shown above (03 marks)
 - i. A.
 - ii. B
 - iii. C
- b) List the organisms above in order of their actual size, starting with the largest (01)
- c) State which of these organisms might bring about decay of organic matter (01)
- d) On the figure above, label (02 marks)
 - A structure (N) that is always made mostly of DNA
 - A structure (P) that is made of protein
2. (a) Explain why it may be incorrect to state that bacteria are unicellular (04 marks)
- (b) With the aid of examples, describe the classification of bacteria as heterotrophic (06)
3. Table 3 shows the output of the contractile vacuoles of two protists of different sizes. The data are the mean value of numerous estimations.

Species	Rate of output/ $\mu\text{m}^3\text{s}^{-1}$	Cell volume/ μm^3	Time to eliminate Equivalent of cell volume/hours
<i>Amoeba proteus</i>	80	1200×10^3	8.5
<i>Paramecium caudatum</i>	105	305×10^3	0.5

(a) i) Compare the rate of the output of the contractile vacuoles in both protists (01 m)

(ii) State the relationship between output and the time taken to eliminate equivalent of cell volume (01 mark)

4. b i) Calculate the rate of discharge of the two protists per hour (02 minutes)

(ii) Calculate the volume of the fluid discharge by the two protists (02 marks)

c) Explain the difference in the volume of fluid discharge by the two protists (04 marks)

(d) Explain why contractile activity is important in the life of protists. (04 marks)

5. (a) State **two** similarities and **three** differences in the structure of the Angiospermophyta and coniferophyta (05 marks)

6. Table 2 below shows the results an investigation in the morphological characteristics of different migratory East African Grasshoppers, *Homorocorypus nitudulus*. Study it carefully and answer the questions that follow

Colour forms	Sex (percentage)		Parentage total
	Female	Male	
Green	42	14	56
Brown	14	28	42
Other colours	1	1	2
Total	57	43	100

a) What general conclusion can you draw from the data? (04 marks)

b) Of what ecological advantage are the green and brown forms? (02 marks)

c) State reasons why class insecta is referred as the most successful class among the classes in phylum arthropoda. (04 marks)

7. Certain animals have the following features in common

Segmentation, setae, bilateral symmetry and a coelom

(a) (i) Name the phylum to which they belong (01 mark)

(ii) State any **one** class of the phylum mentioned in a) (i) above (01 mark)

(iii) Name **one** other phylum which has three of the features stated (01 mark)

(b) State **three** features that distinguish members of the phyla stated in a) i) and a) iii) other than those listed above (03 marks)

8. (a).State **four** distinguishing features of angiosperms (04 marks)

(b) Briefly describe any **six** features of seed plants that have contributed to their success on land?

9. Give 2 **main** differences between

bryophytes and pteridophytes (02 Mar)

(b) There is a wide range of algal types ranging from unicellular chlamydomonas to large multicellular sea weeds. State any;

i. Advantages of multicellular organisms over unicellular organisms. (03 Marks)

ii. Disadvantages of multicellular organisms over unicellular organisms. (02 Marks)

(c) What is the ecological role of algae in the biosphere? (03 Marks)

10. Fungi were originally classified under the plant kingdom.

(a) State the **unique features of fungi** that necessitated them to have a kingdom of their own. (05 marks)

(b) What is the economic importance of fungi in natural ecosystem (05 marks)

11. Hydra is a diploblastic, radially symmetrical animal

(a) Explain how radial symmetry may be an advantage to a sessile animal (02 s)

(b) Hydra exhibits polymorphism

i) What is meant by the term **polymorphism**? (02 marks)

ii) State the forms of polymorphism found in hydra (01 marks)

iii) Of what significance is polymorphism to hydra (02 marks)

(c) Larger animals, such as members of phylum chordate, possess blood systems while smaller animals, such as members of phyla Cnidaria and Platyhelminthes, do not. Explain the link between body size and the possession of a transport system.

12. Distinguish between classes of phylum Angiospermophyta, using features of their stems (05 marks)

(b) (i) Describe the adaptations of angiosperms to life on land (10 marks)

(ii) State any five importances of plants in the environment (05 marks)

13. a) What is meant by the term **alteration of generations** (03 marks)

b) Outline the similarities and differences between Bryophytes and Pteridophytes.

c) What is the significance of alteration of generations? (07 marks)

14. a) What are the adaptations of the plasmodia to its parasitic mode of life (03 marks)

b) Describe the life cycle of plasmodia. (11)

c) Why is malaria still such an unrelenting disease in sub-Saharan Africa? (06 marks)

15. (a) What is meant by alternation of generations. (04 marks)

(b) Give an outline of the life cycle of a moss plant. (09 marks)

(c) How does the lifecycle of a moss plant differ from that of a typical flowering plant? (07 marks)

16. (a) What is meant by the term **alternation of generations**. (03 marks)
 (b) Give an outline of the life cycle of a moss plant. (09 marks)
 (c) How does the life cycle of a moss plant differ from that of a typical flowering plant?
17. (a) State the distinguishing features of the classes of the angiosperms seen in the structure of the stems (05 marks)
 (b) Discuss the characteristic features that have made angiosperms achieve success in the terrestrial environment (15 marks)
18. (a) Describe the process of alternation of generations in a named pteridophyte.
 (b) How are pteridophytes better adapted to life on dry land than bryophytes? (08 marks)

19. Figure 1 below shows the body temperature of a person suffering from a certain kind of malaria.

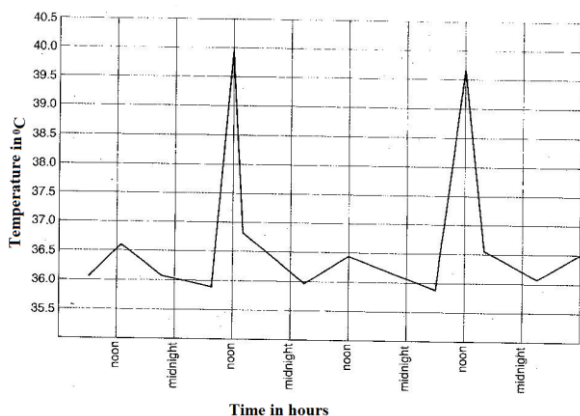

In another experiment, rats were infected with different numbers of the tapeworm, *Hymenolepis diminuta*. After 16 days, the mature worms were measured. Figure 2 below shows the results of the investigation.

Figure 2

Number of worms per rat	Mean mass per worm (g)	Mean number of eggs per gram of worm
1	2.2	3.1×10^6
5	1.35	1.7×10^6
10	0.98	1.05×10^6
30	0.33	0.18×10^6

Echnococcus granulosis is a tapeworm that inhabits intermediate hosts, mainly domestic animals with man as the definitive host. The infection of man with this parasite results from consumption of meat infected with larvae. Figure 3 below shows the results of an investigation of the incidence of this parasite at a Kampala Capital City Authority abattoir.

Figure 3

Month	CATTLE			
	Total slaughtered	Infected livers	Infected lungs	% infection
Jan	1099	10	18	2.5
Feb	1014	1	18	1.8
March	947	8	45	5.6
April	1201	0	71	5.9
May	940	4	59	6.7
June	1070	7	74	7.6
July	1050	8	112	11.4
August	768	8	65	9.5
September	1253	8	81	7.1
October	1091	5	55	5.5

Month	GOATS			
	Total slaughtered	Infected livers	Infected lungs	% infection
Jan	1074	5	15	1.9
Feb	1481	3	8	0.7
March	1055	4	39	4.1
April	1053	0	0	0.0
May	60	0	29	4.8
June	1239	5	42	3.8
July	1209	12	89	8.4
August	1150	5	41	4.0
September	851	3	37	4.7
October	649	2	22	3.7

From figure 1,

- (a) (i) Comment on the data given.
 (ii) Explain the changes in temperature of the patient above
- (b) Give an account of the main features of *Plasmodium* life cycle.

Using the data of figure 2,

- (c) Plot a suitable graph to reflect the results
 (d) What is the effect of crowding of worms on their:
 (i) growth
 (ii) reproduction
 (e) (i) Explain why there never exists more than a single tapeworm, *Taenia* in the human gut.
 (ii) Compare the mode of life of this endoparasite within its host with that of mammalian foetus in the uterus
 (f) Using the figure 3 data,
 (i) Comment on the results
 (ii) Plot histograms of percentage infection for the entire period, using the same axes
 (ii) Account for the observed patterns of infection for both goats and cattle.

END

REFERENCES

1. D. T. Taylor, N.P.O. Green, G.W. Stout and **R. Soper**. Biological Science, 3rd edition, Cambridge University Press
2. M. B. V. **Roberts**, Biology a Functional approach, 4th edition, Nelson
3. C. J. **Clegg** with D. G. McKean, ADVANCED BIOLOGY PRICIPLES AND APPLICATIONS, 2nd EDITION, HODDER EDUCATION
4. Glenn and Susan **Toole**, NEW UNDERSTANDING BIOLOGY for advanced level, 2nd edition, Nelson thornes
5. Michael **Kent**, Advanced BIOLOGY, OXFORD UNIVERSITY PRESS
6. Michael Roberts, Michael Reiss and Grace **Monger**, ADVANCED BIOLOGY
7. J.**SIMPKINS** & J.I.WILLIAMS. ADVANCED BIOLOGY

END

TOPIC 2: CHEMICALS OF LIFE

Syllabus extract

<i>Content</i>	SPECIFIC OBJECTIVES <i>The learner should be able to:</i>
<i>Acids, bases, salts and vitamins.</i>	
<ul style="list-style-type: none"> • Properties of acids, bases, and vitamins • Functions of acids, bases, mineral salts and vitamins in organisms. 	<ul style="list-style-type: none"> • Describe properties of acids, bases and vitamins. • Explain the role of acids, bases, salts and vitamins in maintaining a stable internal environment for physiological processes.
<ul style="list-style-type: none"> • Test for presence of mineral salts in food samples/extracts (<i>refer to inorganic analysis in chemistry practical</i>) • Testing for Vitamin C. • Effects of heat on vitamin C content in vegetables. • Effects of storage on quality of fresh foods. 	<p><i>Mineral salts, to organic</i></p> <ul style="list-style-type: none"> • Identify salts using quantitative and qualitative analysis. • Test for Vitamin C. • Demonstrate the effect of heat on vitamin C content in vegetables. • Demonstrate the effect of storage on quality of fresh foods.
<ul style="list-style-type: none"> • Molecular structure of water. • Functions of water. • Water as a solvent. • Role of water in the life of organisms (Biological significance in relation to properties water.) • Testing for water • Measuring water content in tissues • Field study on water habitats. <p><i>(The natural relationship of water and organisms).</i></p>	<p><i>Water & practical</i></p> <ul style="list-style-type: none"> • Describe the molecular structure of water. • State functions of water. • Explain the importance of water as a solvent. • Relate the water properties to its role in the life of organisms (<i>biological significance</i>) • Test for water • Carry out dry weight technique to determine water content in tissues • Explain the natural relationship of water and organisms in a habitat (including humans)
<ul style="list-style-type: none"> • Structure and components of carbohydrates. • Properties of carbohydrates. • Importance of carbohydrates: monosaccharide, disaccharides, polysaccharides • Condensation of carbohydrates. • Hydrolysis of carbohydrates. 	<p>Structure of Carbohydrates</p> <ul style="list-style-type: none"> • Describe the structure and components of various carbohydrates • Explain properties of carbohydrates. • Explain the functions of carbohydrates in organisms. • Describe condensation of carbohydrates. • Describe hydrolysis of carbohydrates.
<ul style="list-style-type: none"> • Testing for carbohydrates • Hydrolysis of non-reducing sugars to reducing sugars 	<p>Test for carbohydrates Practical</p> <ul style="list-style-type: none"> • Carry out food test for carbohydrates on food samples / extracts. • Demonstrate hydrolysis of non reducing sugars.
<ul style="list-style-type: none"> • Structure and components of lipids molecules. <ul style="list-style-type: none"> • Properties of lipids. • Importance of lipids • Steroid structure. • Effects of lipids and Steroids to organisms • Condensation of fatty acids and glycerol to form 	<p>Structure of Lipids.</p> <ul style="list-style-type: none"> • Describe the structure and components of lipid molecules. • State properties of lipids. • Explain the functions of lipids in the organisms. • Describe structure of steroid.

<p>lipids.</p> <ul style="list-style-type: none"> Hydrolysis of lipids to fatty acids and glycerol. Comparison between waxes and lipids. Importance of cholesterol in organisms. 	<ul style="list-style-type: none"> Explain effects of lipids and steroids to organisms Describe the condensation of fatty acids and glycerol. Describe the hydrolysis of lipids. Compare waxes and lipids. State the importance of cholesterol in organisms.
<ul style="list-style-type: none"> Tests for Lipids Food samples /extracts containing lipids 	<p>Test for lipids practical</p> <ul style="list-style-type: none"> Carry out food tests for lipids on food samples extracts/ extracts Identify food samples/extracts containing lipids.
<ul style="list-style-type: none"> Structure and components of proteins Properties Importance of proteins Functions of proteins (buffer, enzymes/catalytic, growth, carriers e.t.c.) Condensation of amino acids Hydrolysis of proteins Effects of heat on peptide bond linkages or formation in amino acids/ proteins 	<p>Structure of proteins</p> <ul style="list-style-type: none"> Describe the structure and components of proteins. Describe the properties of proteins Explain the importance of proteins Explain the functions of proteins to organisms. Describe condensation of amino acids. Describe hydrolysis of proteins. Explain effects of heat/temperature changes on proteins.
<ul style="list-style-type: none"> Testing for proteins. 	<p>Test for proteins practical</p> <ul style="list-style-type: none"> Carry out food tests for proteins on food samples / extracts
<ul style="list-style-type: none"> Criteria of naming enzymes. (Use of suffix –ase, intracellular and extracellular.) Characteristics of enzymes: Protein in nature i.e. can be denatured. Properties of enzymes relating to factors affecting enzyme activities. <p>Catalytic/change rates of reactions. Work in small amounts. Specific to reactions they catalyze. Reversible reactions. Can be inhibited. Affected by temperature, pH, concentration of substrate and enzymes.</p> <ul style="list-style-type: none"> Factors affecting enzyme action pH, temperature, inhibitors, substrate concentration etc. The lock and key mechanism of enzyme action. <p>Induced fit</p> <ul style="list-style-type: none"> Role of enzymes in living organisms including inhibition, competitive/noncompetitive, reversible/non reversible 	<p>Enzymes</p> <ul style="list-style-type: none"> Describe the criteria for naming enzymes Explain characteristics of enzymes Explain the properties of enzymes State factors that affect enzyme action Explain the lock and key mechanism of enzyme action Explain the role of enzymes in the organisms' life

<ul style="list-style-type: none">• Enzyme properties relating to factors (temperature and pH, concentration of substrate and enzyme) affecting enzymes' activities.• Enzymes in the different parts of the gut based on their actions on different food substances.• Food tests using the animal gut contents and enzymes.	<p>Enzymes</p> <ul style="list-style-type: none">• Demonstrate properties of enzymes action in specific temperature, pH range, substrate/enzyme concentration.• Identify enzymes in the different parts of the gut based on their actions on different food substances.• Carry out food test on gut contents.
---	--

N. Jude. M

Introduction

All living organisms made up of chemicals which constitute the protoplasm of their cells. These are known as the chemicals of life i.e. the chemicals which keep the cells alive.

The study of the chemicals of life and the chemical reactions in which they take place is known as **bio-chemistry**. These chemicals of life are divided into two categories; organic and inorganic chemicals of life.

The **organic chemicals of life** are all derived from carbon and include; carbohydrates, proteins, lipids, nucleic acids (DNA and RNA), waxes and steroids as well as vitamins. The **inorganic chemicals of life** include, water, mineral salts, acids and bases. All inorganic and organic chemicals of life must be supplied in appropriate quantities in the diet except nucleic acids and a few vitamins. Therefore there is need for a balanced diet to keep the cells alive.

INORGANIC CHEMICALS OF LIFE

These are mainly acids, bases, water and inorganic mineral salts such as calcium, magnesium, potassium, nitrates, chlorine, phosphates e.t.c.

ACIDS AND BASES

Acids

A compound which when dissolved in water ionizes to produce hydrogen ions as the only positive charged ions e.g. hydrochloric acid, nitric acid, Sulphuric acids e.t.c.

Note: The strength of the acid is determined by the extent to which it dissociates .e.g. HCl is considered to be a strong acid because it completely dissociates in solution to give hydrogen ions. Whereas ethanoic acid is a weak acid because it partially dissociates in solution

A PH of 7 represents neutrality while a pH below 7 represents acidity while that above 7 represents alkalinity or basis.

Functions of acids

- They provide a suitable pH for the proper functioning of enzymes e.g. pepsin
- Acids like hydrochloric acids activate organic substances like pepsinogen
- Acids kill bacteria, which may be ingested together with food

Bases

A base is a compound, which can react with acids to produce a salt and water only. Some bases are alkalis.

An alkali on the other hand is a substance which when dissolved in a solvent produces hydroxyl ions as the only charged ions. This implies that alkalis are bases but not all bases are alkaline. Strong alkalis completely ionize e.g. $NaOH(aq) \longrightarrow Na^+_{(aq)} + OH^-$

Weak alkali don't ionize completely e.g. ammonium hydroxide

Functions of bases

- Provide an optimum pH range for enzyme activity e.g.in the duodenum
- They are buffers in the body

Buffers

A buffer is a substance that minimizes changes in the concentrations of H^+ and OH^- in a solution when small amounts of acids or bases are added.

The internal pH of most living cells is close to 7. Even a slight change in pH can be harmful because the chemical processes of the cell are very sensitive to the concentrations of hydrogen and hydroxide ions. The pH of human blood is very close to 7.4, which is slightly basic.

Carbonic acid (H₂CO₃), which is formed when CO₂ reacts with water in blood plasma dissociates to yield a bicarbonate ion (HCO₃⁻) and a hydrogen ion (H⁺):

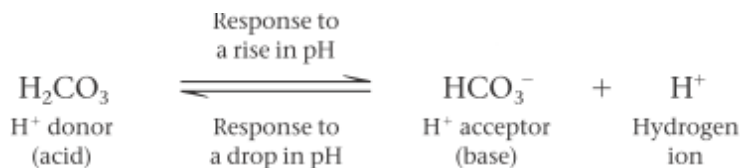

The chemical equilibrium between carbonic acid and bicarbonate is a pH regulator, the reaction shifting left or right as other processes in the solution add or remove hydrogen ions.

Thus, the carbonic acid–bicarbonate buffering system consists of an acid and a base in equilibrium with each other. Most other buffers are also acid-base pairs.

Consider the reactions below;



from the above equations, it is clear that NaHCO₃ removes ions from aqueous solutions thereby lowering the aqueous solutions acidity in so doing it is working as buffer however, though sodium hydrogen carbonate works as a buffer on its own, in most cases two or more compounds interact to form a buffer solution or system.

In case of increased acidity, the NaHCO₃ combines with free hydrogen ions as shown above if alkalinity is increased, it reacts with free hydroxyl ions to form carbonate ions and water.

Salts e.g. K₃ PO₄ Na₃ PO₄ etc combine with hydrogen ions to form H₂PO₄⁻ (Di-hydrogen phosphate).

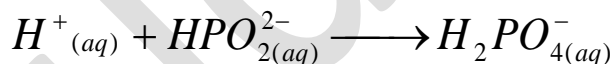

Certain organic compounds like proteins and haemoglobin can also accept H⁺ and are therefore important as buffer. Since they occur in higher ions, than the phosphate salts they are even more important than the acids and the bases. The biological importance of these buffers is that cells and tissues can only function properly at a narrow range of pH, which is usually around neutrality.

Acids and bases also provide rightful pH ranges for certain chemical reactions to effectively proceed in the body basicity.

NB: A number of acids are found in the body and these include

- Nucleic acid
- succinic acid
- HCl
- amino acids
- lactic acid
- Uric acid

MINERAL ELEMENTS

A salt is a compound which is formed when the hydrogen ions in an acid are either partially or fully replaced by a metal ion or NH₄⁺ e.g.

HCl	NaCl, KCl, NH ₄ Cl
H ₂ CO ₃	Na ₂ CO ₃ , NaHCO ₃
CH ₃ COOH	CH ₃ COONa

Functions of mineral salts

1. They form body structures e.g. the bones, the teeth, etc. Comprise calcium ions, phosphate ions etc. They also form connective tissue and other structures a body.
2. They form body pigments e.g. Haemoglobin contains Iron, cytochromes contain copper and chlorophyll contains magnesium.
3. They form chemicals in the body e.g., Sulphur and Nitrogen form proteins, nucleic acids, ATP etc.
4. They are metabolic activators. Certain ions activate enzymes e.g. magnesium activates enzymes that are involved in phosphorylation of glucose.
5. They are constituents of enzymes e.g. nitrogen in proteins.
6. Constituents of various chemicals e.g. ATP contains phosphorous while thyroxin contains iodine.
7. They are determinants of osmotic pressure. Mineral salts and other solutes determine the osmotic pressure of cells and body fluid. The osmotic pressure must not be allowed to fluctuate beyond narrow limits since much of the physiology is directed to preventing this.

The mineral ions in the body can be grouped as major or minor ions depending of their need in the body.

Major/ macro ions are needed fairly in large amounts than **minor ions**.

Mineral element	major dietary sources for humans	Major functions in the body	Symptoms of deficiency or excess in animals
MACRO ELEMENTS			
Calcium	Dairy products, dark green vegetables and legumes	bone and tooth formation , blood clotting, nerve and muscle function	Retarded growth, possibly loss of bone mass
			Stunted growth
Phosphorous	Dairy products, meats and greens	bone and tooth formation , acid-base balance, nucleotide synthesis	Weakness, loss of minerals from bones, calcium loss
			Stunted growth particularly of roots
Sulphur	Proteins from many sources	Proteins from many sources	Symptoms of protein deficiency
			Chlorosis
Potassium	Meats, dairy products, grains, many fruits and vegetables,	Acid-base balance , water balance and nerve function, cofactor in photosynthesis and respiration	Muscular weakness, paralysis, nausea , heart failure
			Yellow and brown leaf margins; premature death;
Chloride	Table salt	Acid-base balance, formation of gastric juice, nerve function, osmotic balance	Muscle cramps, reduced appetite
Sodium	Table salt	Acid-base balance, nerve function, water balance	Muscle cramps, reduced appetite
Magnesium	Whole grains, green leafy vegetables	Co-factor, ATP synthesis	Nervous system disturbance
			Chlorosis
Nitrogen			Stunted growth

	Lean meat, fish, milk	Synthesis of proteins, nucleic acids; formation of chlorophyll and a coenzyme	Stunted growth and strong chlorosis of old leaves
MICRO ELEMENTS			
Iron	Meats, eggs, legumes, whole grains, green leafy vegetables	Component of haemoglobin and of electron carriers in energy metabolism, enzyme cofactor	Iron-deficiency anaemia, weakness, impaired immunity strong chlorosis of young leaves
Fluorine	Drinking water, tea, seafood	Maintenance of tooth and bone structure	Higher frequency of tooth decay
Zinc	Meats, seafood, grains	Components of certain digestive enzymes and other proteins	Growth failure, skin abnormalities, reproductive failure, impaired immunity Malformed leaves e.g. in cocoa
Copper	Seafood, nuts, legumes, organ meats	Enzyme cofactor in iron metabolism, melanin synthesis, electron transport	Anemia, cardiovascular abnormalities Die back of shoots
Manganese	Nuts, grains, vegetables, fruits, tea	Enzyme cofactor	Abnormal bone and cartilage Leaf flaking e.g. grey specks in oats
Iodine	Seafood, dairy products, iodized salt	Components of thyroid hormones	Goiter
Cobalt	Meats and dairy products	Component of vitamin B ₁₂	None except as B ₁₂ deficiency
Selenium	Seafood, meats, whole grains	Enzyme cofactor; antioxidant functioning in close association with vitamin E	Muscle pain, possibly heart muscle deterioration
Chromium	Brewer's yeast, liver, seafood, meats, some vegetables	Involved in glucose and energy metabolism	Impaired glucose metabolism
Molybdenum	Legumes, grains, some vegetables	Enzyme cofactor	Disorder in excretion of nitrogen containing compounds

WATER

a) Structure

Water is formed when two hydrogen atoms combine with an oxygen atom by sharing electrons. The result is a stable molecule, which is relatively unreactive. The shape of the water molecule is triangular rather than linear (*figure 1*) and the angle between the nuclei of the atoms is approximately 105° . Overall the molecule is electrically neutral, but in both of the oxygen-hydrogen bonds, the oxygen draws electrons away from the hydrogen nucleus. Thus there is a net negative charge on the oxygen atom and a net positive charge on the hydrogen atom. A molecule that carries an equal distribution of electrical charge (*figure 2*) is called a **polar molecule**. **Polarity** is uneven charge distribution within the molecule. In water one part or pole of the molecule is slightly negatively charged and the other slightly positive, this is known as **dipole**. This occurs because the oxygen atom has a greater electron attracting power (electronegativity) than the hydrogen atoms. As a result, the oxygen atom pulls the bonding electrons more towards itself than towards hydrogen. These attractions are not as strong as normal ionic or covalent bonds and are called **Hydrogen bonds**.

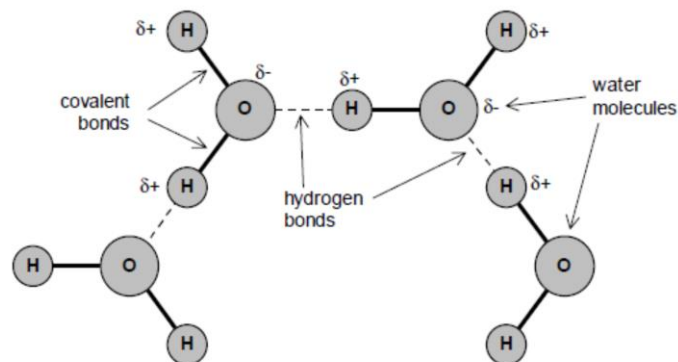

Figure 1

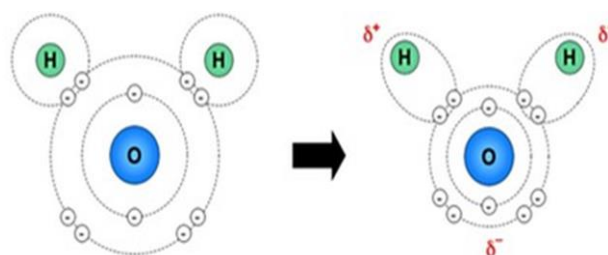

Figure 2

They are constantly formed, broken and reformed in water although individually weak their collective effect is responsible for the unusual properties of water.

Because of this charge separation, water is an overall neutral molecule. Water molecules form relatively weak **hydrogen bonds** with other water molecules. Hydrogen bonds are also formed with any charged particles that dissolve in water, and charged surfaces in contact with water. Hydrogen bonds account for the unique properties of water.

b) Functions

Water is biologically important as shown by each of its properties.

1. Solvent properties

It is a universal solvent for **polar substances** (charged or ionisable substances) e.g. salt and it is also a solvent for **non-polar substances** e.g. sugar. It is able to attract other polar substances, forming Hydrogen bonds with them, thereby dissolving them. Polar molecules such as salts, sugars and amino acids dissolve readily in water and so are called hydrophilic ("water loving"). Uncharged or non-polar molecules such as lipids do not dissolve so well in water and are called hydrophobic ("water hating"). Most non-polar substances such as lipids are immiscible in water and serve to separate aqueous solutions into compartments.

This property enables water to carry out the following functions;

- i. It is a lubricant e.g. in the joints where it forms the synovial fluid which enables protection against damages.

- ii. It acts as a transport medium as blood, lymph, in the excretory system as well as in the alimentary canal where it transports materials from one point to another.
- iii. It is an important constituent of the excretory waste products, by which toxic materials are removed from the body.
- iv. It is the largest constituent of the protozoan protoplasm of all cells where it contributes up to **60%**.

2. Water has a high specific heat capacity

Heat capacity refers to the amount of heat required to raise the temperature of 1 kg of water by 1°C. The high heat capacity of water means that the large increase in heat energy around water results into a relatively small rise in the temperature of water because much of the energy supplied to water is used in breaking the hydrogen bonds which restricts the movement of molecules. The temperature changes within water are therefore minimized as a result of its high heat capacity, this property is significant because;

- i. It enables life processes such as temperature regulation and gaseous exchange to occur in organisms.
- ii. Such a suitable temperature enables body enzymes to function well without denaturation and/or inactivation.
- iii. It provides a constant internal and external environment for many cells and organisms.

3. High heat of vaporization

A relatively large amount of energy is needed to vapourise water due to the hydrogen bonds within water and as a result water has a high boiling point. The transition of water from a liquid to a gas requires the input of energy to break its many hydrogen bonds, the evaporation of water from a surface causes cooling of that surface. This is made use of as a cooling mechanism (evaporative cooling) in animals (sweating and panting) and plants (transpiration). As water evaporates it extracts heat from around it, cooling the organism. This is significant because;

- a. It results into the cooling of the organisms so as to reduce body temperature.
- b. It is an important heat sink where large bodies of water are responsible for modifying climate by absorbing heat from the sun.

NOTE.

The energy transferred to water molecules to allow them vapourise results in loss of energy from their surroundings so that cooling takes place.

4. High heat of fusion

Latent heat of fusion is the amount of heat energy required to melt a solid such as ice.

With its high heat capacity, water requires relatively large amounts of heat energy to melt from ice to liquid water. Liquid water therefore must lose a relatively large amount of heat energy to freeze. This property is important because it ensures that the cell contents and their environments are unable to freeze.

5. Density and freezing properties

The density of water decreases below 4°C and ice therefore floats on relatively warmer water below. Water below 4°C tends to rise which maintains the circulation in large water bodies therefore this property is important because;

- i. It makes water an important factor in the cycling of nutrients needed by living things.
- ii. It makes water a suitable habitat for many aquatic organisms, both plants and animals.

6. High surface tension and cohesion

Cohesion is the force of attraction between molecules of the same kind. At the surface of the liquid a force called surface tension exists between the molecules due to the cohesive forces between the molecules. This causes the water surface to occupy the least possible surface area. Water has a higher surface tension than any other liquid.

This property is important as follows;

- a. The high cohesion of water molecules enables the movement of water through the xylem to the leaves.
- b. Surface tension enables small organisms to settle on water or skate over the water surface (*figure 3*)
- c. It enables the water to participate in the absorption of mineral salts from the soil.



Figure 3

7. Water as a reagent

As a reagent, water is an essential metabolite i.e. it participates in the chemical reactions of metabolism. This property is significant in the following ways;

- a. Water is a raw material of most bio-chemical reactions taking place such as photosynthesis, respiration, and digestion.
- b. Water is a medium in which most bio-chemical reactions take place.
- c. Water is a pre-requisite for fertilization, where fertilization involves mobile gametes e.g. external fertilization in lower plants, fish, amphibians, and internal fertilisation in higher vertebrates and plants.

8. Incompressibility

This property enables water to carry out the following functions;

- a. It forms the hydro-static skeleton of animals such as earthworms.
- b. It provides support to the non woody plants e.g. herbaceous plants by maintaining turgidity of the cells.
- c. Water provides stomata movement, movement of leaves, opening and closing the flowers e.t.c. to take place through changes in the turgidity of the cells.

9. High tensile strength

Water can be lifted by forces applied at the top as seen in movement of water to the xylem of tall trees due to strong cohesive forces between water and the walls of the conducting vessels.

10. Water is transparent

It is important because it enables light to penetrate the water bodies to allow photosynthesis of aquatic plants and also to allow vision to the aquatic animals.

11. Water is denser than air

Water supports organisms as large as whales. It also supports and disperses reproductive structures such as larvae and large fruits e.g. coconuts.

12. pH

Water itself is partially ionized $H_2O_{(l)} \longrightarrow H^+_{(aq)} + OH^-_{(aq)}$ so it is a source of protons (H^+ ions), and indeed many biochemical reactions are sensitive to pH ($-\log [H^+]$). Pure water cannot buffer changes in H^+ concentration, so it is not a buffer and can easily be any pH, but the cytoplasm and tissue fluids of living organisms are usually well buffered at about neutral pH (pH 7-8).

13. Water has a low viscosity

This is a measure of how resistant a liquid is to flowing. The lower the viscosity the easier the liquid flows. Water has a viscosity that is lower than that of ethanol. The ease with which water flows is important in the transport system of living organisms e.g. in blood as it flows through vessels.

- The significance of this property is that water can easily be pumped and moved in the small tubes of the body.
- Water also forms a medium within which swimming is made easy.
- Water can flow freely through narrow vessels.
- Watery solutions can act as a lubricant

If too much water is lost from the body, then the viscosity of blood increases, flow slows and transport is less efficient.

Plants rely on the flow of water in the xylem and phloem vessels to transport substances around their bodies.

Aquatic organisms too are able to swim in water because of the relatively low viscosity of water.

BIOLOGICAL IMPORTANCE OF WATER TO ALL ORGANISMS**Metabolic role of water**

- i. Hydrolysis
Water is used to hydrolyse many substances like proteins to amino acids, fats to fatty acids and glycerol, starch to maltose,
- ii. Medium for chemical reactions
All biochemical reactions take place in aqueous medium provided by water.
- iii. Diffusion and Osmosis
It is essential for the diffusion of materials across surfaces such as the lungs or the alimentary canal e.g. diffusion of food materials into the blood stream since such surfaces are moist to facilitate diffusion and the moisture is provided by water.
- iv. Photosynthetic substrate
Water is a raw material for photosynthesis

Water as a solvent

It dissolves other substances and is therefore used in the following ways;

- i. Transport
The solvent properties of water mean that it is a transport medium, as it is in blood plasma, tissue fluid, lymph, in mammals and Xylem and Phloem in plants. They are all made up of water and dissolve a number of substances which can then be easily transported.
- ii. Excretion
Metabolic wastes like ammonia, urea, excess salts require water to be removed from the body in solution form.
- iii. Secretion

They are transported from their place of secretion in solution form (aqueous form) e.g. most digestive juices have enzymes in solution, tears mainly consist of water, snake venoms have toxins in suspension composed of water.

Water as a lubricant

Water' properties especially its viscosity makes it a useful lubricant. Lubricating fluids that have a component of water include;

- Mucus which externally facilitates movement in organisms like the snail and earthworm or internally in the walls of the gut and vagina
- Synovial fluid which lubricates movements in the joints of vertebrates.
- Pleural fluid which lubricates movements of the lungs during breathing
- Pericardial fluid which lubricates movements of the heart
- Peri visceral fluid which lubricates movements of internal organs like peristaltic movement of the alimentary canal

Supporting role of water

With its large cohesive forces, water molecules lie close together due to the hydrogen bonds between them and therefore not easily compressed, making it a useful means of supporting organisms.

- i. Hydrostatic skeleton
Animals like earthworms are supported by the pressure of the aqueous medium within them.
- ii. Turgor pressure
Herbaceous plants and herbaceous parts of woody plants are supported by osmotic influx of water into their cells.
- iii. Humours of the eye
Aqueous and vitreous humours give the shape of the eye and they are mainly made up of water.
- iv. Amniotic fluid
It supports and protects the mammalian foetus during development and is mainly made up of water.
- v. Erection of the penis
The pressure of blood which is mainly made up of water makes the penis erect for copulation to take place.
- vi. Habitat
Water supports organisms that live in it. Very large organisms like whales return to water as their sizes make movement on land very difficult.

Other biological functions of water include

- Water enables dispersal of seeds and fruits such as coconut as well as dispersal of the gametes and larval forms of aquatic organism. Medium of dispersal i.e. seed dispersal, gametes and larvae stages of some aquatic organisms
- Seed germination
- Osmoregulation
- Migration of aquatic organisms
- Fertilization, by transporting gametes
- Hearing and balance. The watery endolymph and perilymph in the mammalian ear plays a significant role in hearing and balancing
- It breaks the testa of seeds to allow embryo growth during germination.
-

THE ORGANIC CHEMICALS OF LIFE

These are the chemicals of life which always contain carbon, hydrogen and oxygen as the major elements. The proteins and nucleic acids in addition to these elements also contain nitrogen. These organic chemicals of life are important because of the following reasons;

- They are the structural components of the bodies of organisms.

- They are regulators of chemical processes occurring in organisms.

These organic chemicals of life include the following; **carbohydrates, proteins, lipids, vitamins** and **nucleic acids**

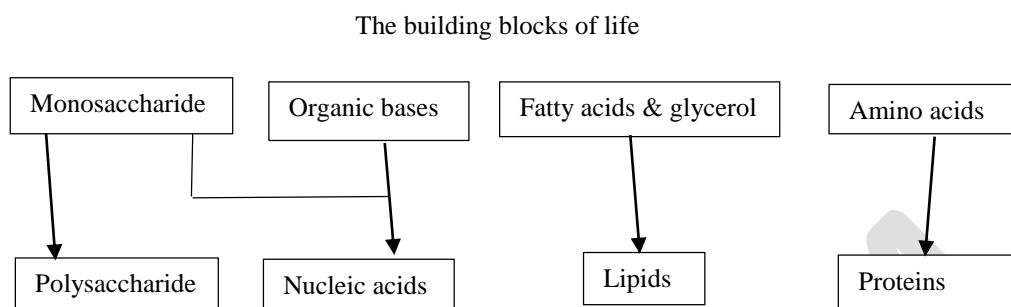

VITAMINS

Vitamins are organic molecules with diverse functions that are required in very small amounts. For humans, 13 essential vitamins have been identified and are classified as water-soluble or fat-soluble.

Vitamins	Major dietary sources	Major functions in the body	Symptoms of deficiency
			<i>Extreme excess</i>
Water soluble vitamins			
Vitamin B₁ Thiamine	Pork, legumes, peanuts, whole grains	Coenzymes used in removing carbon dioxide from organic compounds	Beriberi (nerve disorders, emaciation anemia)
Vitamin B₂ Riboflavin	Dairy products, meats, enriched grains, vegetables	Component of coenzymes FAD and FMN	Skin lesions such as cracks at corners of the mouth
Vitamin B₃ Niacin	Nuts, meats, grains	Component of coenzymes NAD ⁺ and NADP ⁺	Skin and gastrointestinal lesions, nervous disorders <i>Liver damage</i>
Vitamin B₆ Pyridoxine	Meats, vegetables, whole grains	Coenzyme used in amino acid metabolism	Irritability, convulsions, muscular twitching, anemia <i>Unstable gait, numb feet, poor coordination</i>
Vitamin B₅ Pantothenic acid	Most foods: meats, dairy products, whole grains e.t.c.	Component of coenzyme A	Fatigues, numbness, tingling of hands and feet
Vitamin B₉ Folic acid (folanin)	Green vegetables, oranges, nuts, legumes, whole grains	Co enzyme in nucleic acid and amino acid metabolism	Anemia, birth defects <i>May mask deficiency of vitamin B₁₂</i>

Vitamin B₁₂	Meats, eggs, dairy products	Co enzyme in nucleic acid metabolism, maturation of red blood cells	Anemia, nervous system disorders
Biotin	Legumes, other vegetables, meats	Coenzyme in synthesis of fat, glycogen, and amino acids	Scaly skin inflammation, neuromuscular disorders
Vitamin C Ascorbic acid	Fruits and vegetables especially citrus fruits, cabbage, tomatoes, green pepper	Used in collagen synthesis (such as for bone, cartilage, gums); antioxidant; aids in detoxification; improves iron absorption	Scurvy (degeneration of skin, teeth, blood vessels), weakness, delayed wound healing, impaired immunity <i>Gastrointestinal upset</i>
fat soluble vitamins			
Vitamin A Retinol	Beta-carotene (pro-vitamin A) in green and orange vegetables, retinal in dairy products	Component of visual pigments, maintenance of epithelial tissues, antioxidant, helps prevent damage to cell membranes	Blindness and increased death rate <i>Headache, irritability, vomiting, hair loss, blurred vision, liver and bone damage</i>
Vitamin D	Dairy products, egg yolk; also made in human skin in presence of sunlight	Aids in absorption and use of calcium and phosphorous; promotes bone growth	Rickets (bone deformities) in children, bone softening in adults <i>Brain, cardiovascular, and kidney damage</i>
Vitamin E Tocopherol	Vegetable oils, nuts, seeds	Antioxidant; helps prevent damage to cell membrane	Desecration of the nervous system
Vitamin K phylloquinone	Green vegetables, tea; also made by the colon bacteria	Important in blood clotting	Defective blood clotting <i>Liver damage and anemia</i>

CARBOHYDRATES

These are organic compounds made up of carbon, hydrogen and oxygen, in which the ratio of hydrogen to oxygen is 2:1 as in water. The word carbohydrate suggests that these organic compounds are hydrates of carbon. They have a general formula of $C_n(H_2O)_m$ where m and n are either the same or different units (n = number of carbon atoms). Most examples of carbohydrates do conform to the general formula e.g.

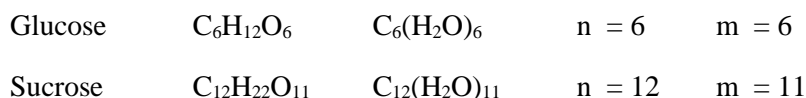

Some few carbohydrates do not conform to the general formula e.g. Deoxyribose sugar, $C_5H_{10}O_4$

Carbohydrates are mainly concerned with the **storage and liberation of energy**. A few carbohydrates such as cellulose form important structures of organisms e.g. the plant cell walls.

Chemically carbohydrates have the following properties;

- i. They are either aldehydes or ketones.
- ii. They contain hydroxyl groups.

There are 3 groups of carbohydrates namely;

- Monosaccharides (single sugars).
- Disaccharides (double sugars)
- Poly saccharides (Many sugars or complex sugars)

MONOSACCHARIDES

These are a group of sweet, soluble, crystalline molecules of relatively low molecular mass made of a single sugar. They may contain either an aldehyde group or a ketone within their molecule. If they contain an aldehyde group (-CHO) they are called **aldoses** or **aldo-sugars** (figure 4) such as glyceraldehyde. If they contain a ketone >C=O group in their molecules, they are called **ketoses** or **keto-sugars** (figure 5) such as dihydroacetone.).

Note: The carbon atom with a double bond in Aldehydes is at the end of the chain while in Ketones it is on the second carbon or on the carbon next to last

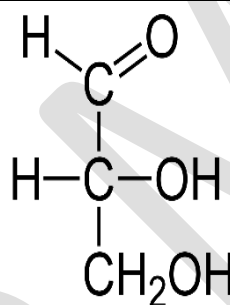

Figure 4

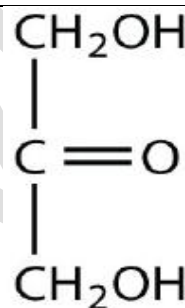

Figure 5

The general formula for Monosaccharides is $(\text{CH}_2\text{O})_n$ where n = number of carbon atoms. Where $n=3$, the sugar is called a **triose sugar** (e.g. glyceraldehyde and dihydroxyacetone), where $n=5$, **pentose sugar** (e.g. Ribulose and ribose) and when $n=6$ **hexose sugar** (e.g. mannose, fructose, galactose, glucose, sorbose).

The names of monosaccharides end with a suffix - ose.

Monosaccharides have ringed structure (Figure 6) and they exhibit **isomerism**. *Isomers* are compounds with the same molecular formulas but different structure formulae. For example, the formula $\text{C}_6\text{H}_{12}\text{O}_6$ can be used for glucose, fructose and galactose.

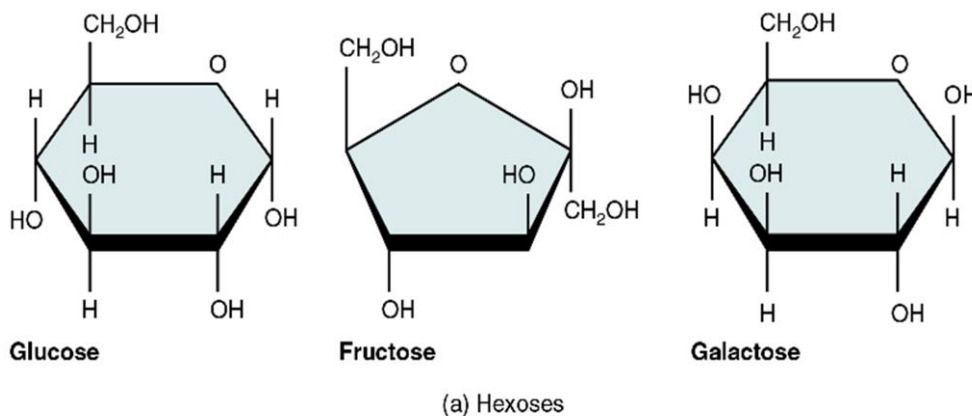

Figure 6

Monosaccharides can link together to form larger molecules i.e. they form building units used to form complex sugars. Some monosaccharides act as a source of energy when oxidized in respiration e.g. glucose.

Existence of α and β rings gives a greater chemical variety and helps in building up the complex carbohydrate atom on the 4th carbon atom to give a 5-member ring called fructose ring. In the Hexoses, it is a 6-member ring called pyranose. Consider the ribose ring below.

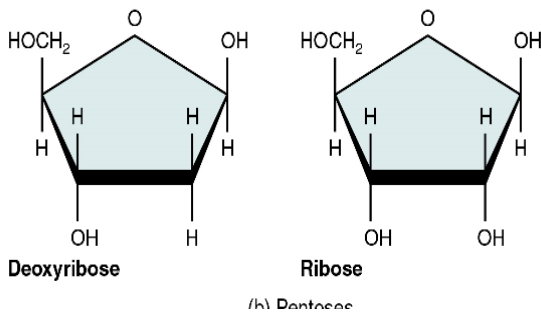

Figure 7

Most of the monosaccharides are the **reducing sugars** because they reduce Cu^{2+} in Benedict's solution to Cu^+ ions giving an orange precipitate of copper (I) oxide (Cu_2O). They have an aldehyde group or a free ketone group. Ketoses first isomerise to aldoses before they can act as reducing sugars.

The structures of the various isomers of monosaccharides include the following;

GLUCOSE ($\text{C}_6\text{H}_{12}\text{O}_6$)

β - Glucose differs from α -glucose in that at carbon 1 in β – glucose, the -OH group faces upwards while α - glucose it faces downwards

β - glucose (beta glucose)

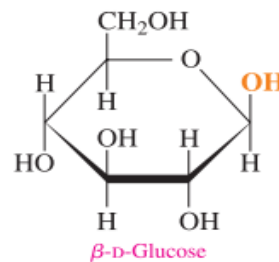

α - glucose (Alpha glucose)

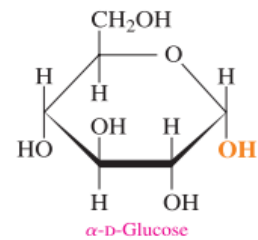

Fructose ($\text{C}_6\text{H}_{12}\text{O}_6$)

Pyranose (β – fructose)

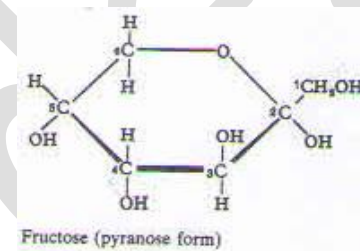

Furanose (α - fructose)

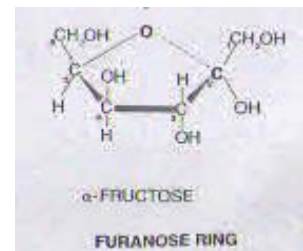

Importance of monosaccharides

Trioses $\text{C}_3\text{H}_7\text{O}_3$ e.g. glyceraldehydes, dihydroxyacetone are intermediates in respiration, photosynthesis and other branches of carbohydrate metabolism.

Pentoses $\text{C}_5\text{H}_{10}\text{O}_5$ e.g. ribose, ribulose, deoxyribose

- i. Synthesis of nucleic acid; Ribose is a constituent of RNA, deoxyribose of DNA.
- ii. Synthesis of some co-enzymes e.g. Ribose is used in the synthesis NADP and NAD, FAD.
- iii. Synthesis of (ATP), ADP AMP also requires ribose.
- iv. Ribulose biphosphate is the CO_2 acceptor and is made from a 5C sugar ribulose.

Hexoses e.g. glucose, fructose, galactose

- v. Source of energy when oxidised in respiration; glucose is the most common monosaccharide.
- vi. Synthesis of disaccharides; two monosaccharide can link together to form a disaccharide.
- vii. Synthesis of polysaccharides; glucose is particularly important in this role

DISACCHARIDES

A disaccharide is a sugar formed as a result of the combination of two monosaccharides sugars. Because of this reason they are also known as **double sugars**.

General formula $C_{12}H_{22}O_{11}$ and not $C_{12}H_{24}O_{12}$ as expected because these formations involve the loss of one water molecule as shown in the equation below;

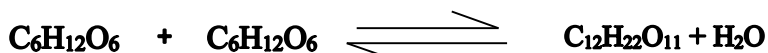

Such a reaction which involves the loss of a water molecule during the synthesis of a new compound, is known as a **condensation reaction**. The two monosaccharide units in a disaccharide are held together by a covalent bond known as a **glycosidic bond** through the loss of small molecules usually water. A condensation reaction between the hydroxyl groups at carbon 1 of one monosaccharides and carbon 4 of the other results in a bond called **1-4 glycosidic bond**. If the reaction is between the hydroxyl groups at carbon 1 and carbon 6, **1-6 glycosidic bond**.

The addition of water, under suitable conditions, is necessary if the disaccharide is to be split into its constituent monosaccharides. This is called **hydrolysis** i.e. breakdown by water.

Most disaccharides are reducing sugars however there are some few which are non-reducing sugars e.g. sucrose because they lack the reducing group in these molecules.

Like monosaccharides, disaccharides are also sweet, soluble in water and crystalline like monosaccharides

Formation of disaccharides

This is illustrated by the following example

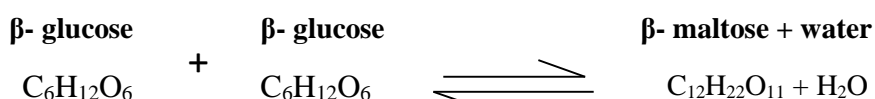
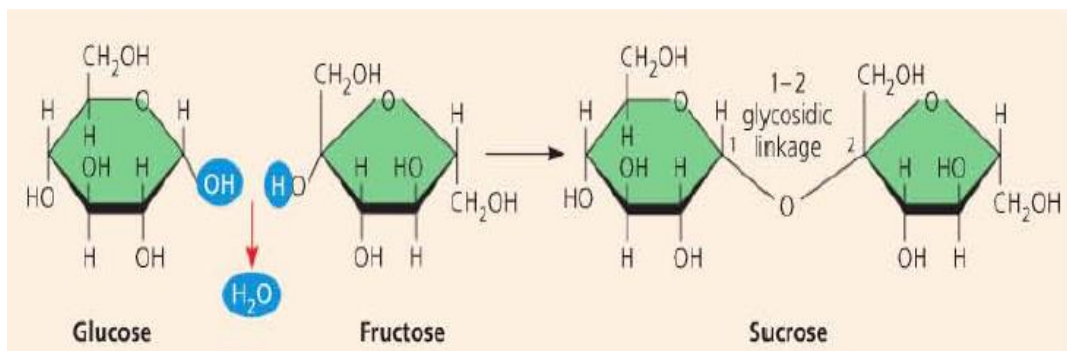
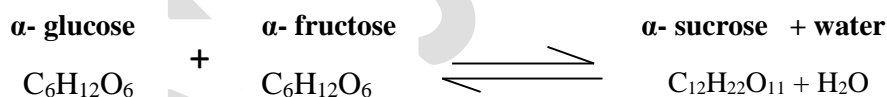
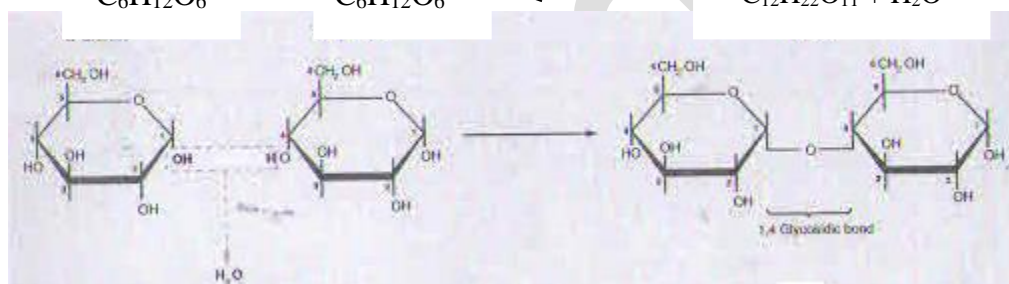
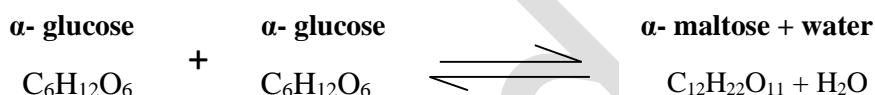

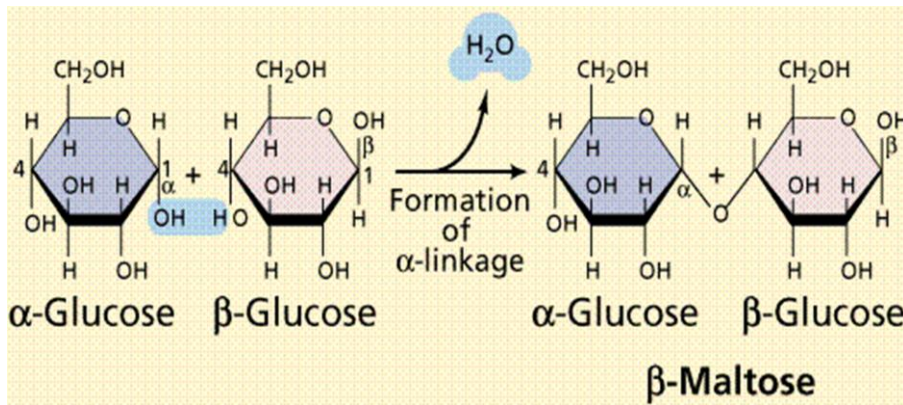

Note. Monosaccharide monomers may also combine other types of molecules to form **conjugated molecules**. Chains of monosaccharide units can combine with lipids to form glycolipids, or with proteins to form glycoproteins. These molecules are important in the cell membrane.

Functions of disaccharides

- They are food reserves in organisms and when they are hydrolysed to monosaccharide and used in cell metabolism.
- Storage materials in some plants like sugar canes.
- They are energy reserves.
- They are the main forms of transport of organic substances in the phloem. Sucrose is particularly important as the main form of transport of organic solutes in the phloem. This is because sucrose is soluble but metabolically inert hence does not cause an osmotic pressure in plant cells. Glucose is not transported because it's soluble and metabolically active hence causing an osmotic potential in plant cells which can affect the movement of water in plant cells.
- Lactose, also called milk sugar, is the nutritional source of energy for infants during nursing. Lactose makes milk taste sweet and is an ingredient in many processed foods that contain dairy such as breads, cookies, cakes, doughnuts, breakfast bars and ice cream.

NB: Starch is hydrolysed in plants to maltose so as; -

- To be transported easily because it's soluble in water.
- Maltose is less reactive hence won't be used.

POLYSACCHARIDES

These are the sugars formed when many monosaccharides combine as a result of condensation reactions to form chains. The chains in polysaccharides may be of;

- Variable length although usually very long.
- Branched or unbranched.
- Folded in which case they are suitable for storage e.g. starch
- Straight or coiled: in which case they are ideal for making meshes and for construction e.g. in cellulose used in building cell wall.

Most polysaccharides are formed from hexose sugars and the general formula of $(C_6H_{10}O_5)_n$ where n is a number greater than 40.

Characteristically polysaccharides are un-sweet, insoluble in water and non-crystalline. Due to their insolubility in water, they form good storage compounds in organisms because they cannot diffuse out of the cell and they do not affect the osmotic potential of the cells.

The most common polysaccharides are *starch*, *cellulose* and *glycogen*. Other polysaccharides include inulin and chitin. All polysaccharides are non-reducing sugars.

Upon hydrolysis, polysaccharides can be converted into their constituent monosaccharides such as glucose, ready for use as a respiratory substrate.

Polysaccharides are normally used for food storage because; -

- i. They can be easily hydrolysed to sugars when required for production.
- ii. They fold into compact shapes which cannot diffuse out of the cells.
- iii. They exert no osmotic or chemical influence on the cell.
- iv. They have large sizes that make them insoluble in water.
- v. They are non-diffusible i.e. they don't leave sites of storage
- vi. Making structures compact e.g. cellulose.

STARCH

Starch is made up of two major components namely *amylose* (20% of starch) and *amylopectin* (79% of starch). The 1% of starch is made of other substances such as phosphates.

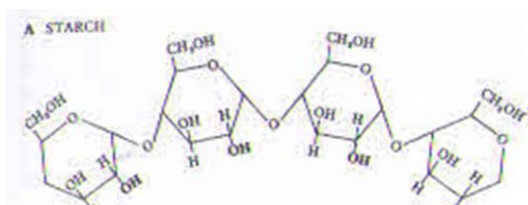

Starch is made up of many **alpha glucose** molecules which is found in most parts of the plant. Starch is made from excess glucose produced during photosynthesis and it is the reserve food in plants.

It is common in the seeds of most plants such as maize where it forms the food supply for germination.

Amylose consists of unbranched chains while amylopectin consists of branched chains. These chains are coiled to form a helix in amylopectin where the -OH groups project into the interior and cannot therefore be free to take part in hydrogen bonding.

For this reason amylopectin has no cross linkages as amylose whose -OH groups point outwards and can therefore form hydrogen bonds. Therefore starch is not strong enough as a structural polysaccharide like cellulose. Due to its branching and numerous ends, amylopectin can easily be broken down to maltose by amylase enzyme at a higher rate as compared to amylose

AMYLOSE	AMYLOPECTIN
It has only 1-4 glycosidic bonds	It has both 1-4 and 1-6 glycosidic bonds
It stains deep blue with iodine.	It stains red to purple with iodine.
Its related molecular mass is 50,000.	Its relative molecular mass is 500,000.
It is made up of un branched helical chains.	It is made up of branched helical chains.
It is made up of 300 glucose units.	It is made up of 1300 glucose units.

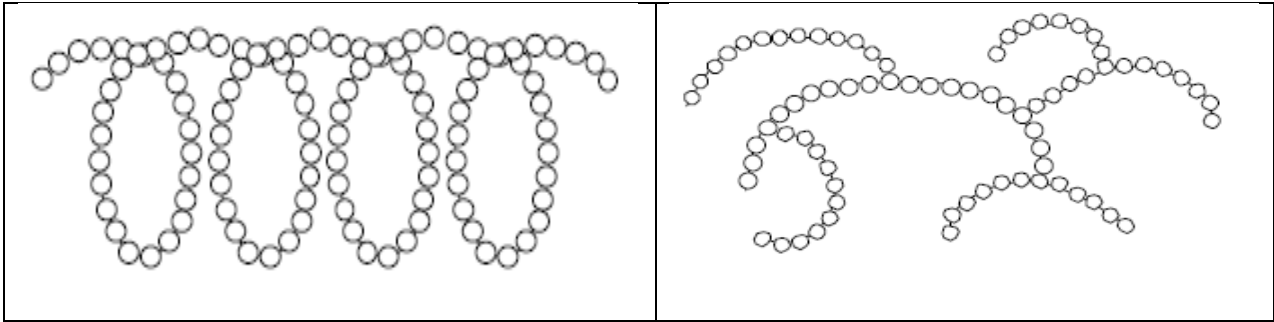

GLYCOGEN

This is the major polysaccharide storage material in **animals** and **fungi**. It is stored mainly in the liver and muscles this is mainly because it provides energy more readily than fat within the active tissues of the muscles and the liver.

Besides glycogen can be used during anaerobic respiration to provide energy in the muscles e.g. during heavy and physical exercise.

Like starch, glycogen is made up of alpha glucose molecules structure is similar to that of amylopectin except that it has highly branched short tails of alpha glucose molecules as compared to amylopectin. Because it is so highly branched, it can be broken down to glucose very quickly by enzyme **glycogen phosphorylase** to release energy.

It is more soluble in water than starch.

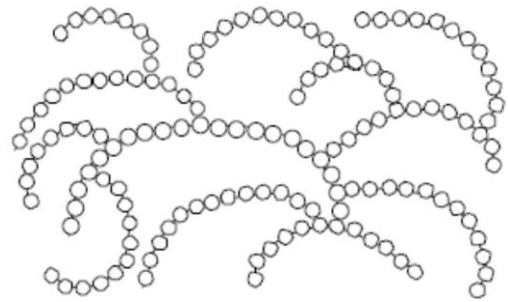

CELLULOSE

This is a polysaccharide made of many **beta glucose** molecules that form long unbranched parallel chains.

It is mainly found in plants because it is the main structure material in plant cell walls and in cotton it makes up to 90%.

Many chains run parallel to each other and have cross linkages between them. These cross linkages give cellulose its considerable stability which makes it a valuable structural material. This stability also makes it difficult for animals to digest cellulose and therefore it is not such a valuable food source to the animals.

The difference in the positions of the -OH and the H groups between the alpha glucose and beta glucose on carbon one affects the structural properties of cellulose, in that, the -OH group on carbon 1 in beta glucose faces upwards while it faces downwards in alpha glucose. This makes the -OH groups in cellulose to project outwards from both sides at alternate positions. Cellulose consist of straight chains of molecules where the -OH groups project outwards on both sides of the chain to alternate position which enable cellulose to form cross linkages therefore the free -OH groups are in exposed positions for hydrogen bonding with neighbouring -OH groups of other chains which results in the formation of bundles of cross linked parallel chains.

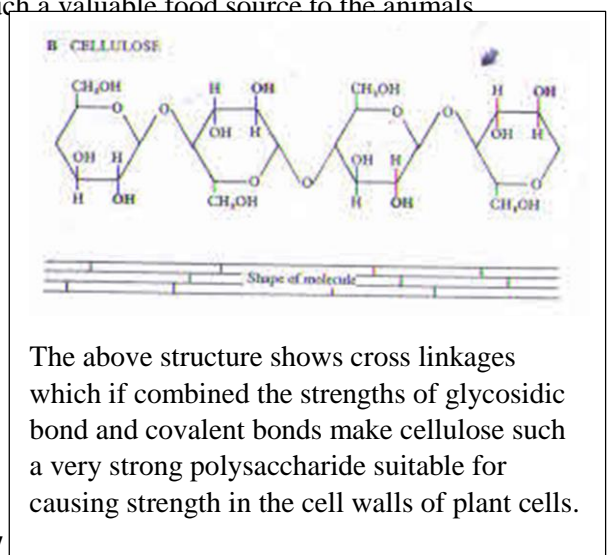

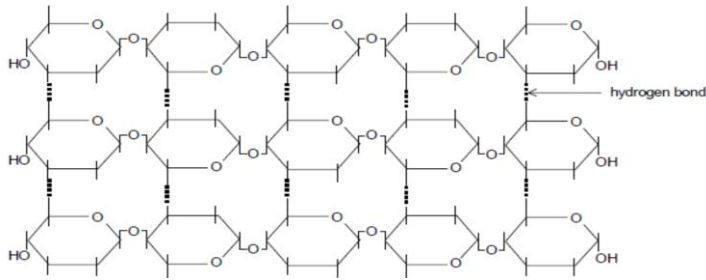

Cellulose is commercially used in textiles in the making of papers, cellophane, tyre cords and celluloid that is used in making photographic films because its chains are linked by hydrogen bonds to make cellulose microfibrils which are very strong and rigid and therefore give strength to plant cells and young plants. It is also food for some bacteria and protozoans

OTHER POLYSACCHARIDES

These include the following;

CHITIN

Chemically and structurally chitin resembles cellulose however it differs from cellulose in possessing an acetyl group instead of one of the hydroxide groups in beta glucose.

Like cellulose, it has a structural function and it is the major component of the exoskeleton of insects and crustaceans. It is also found in fungal cell walls.

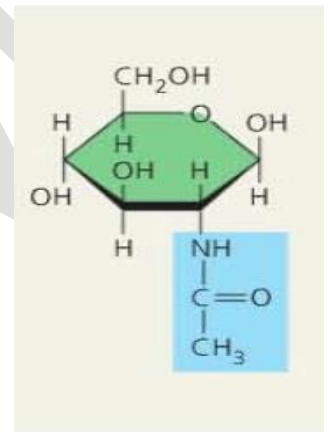
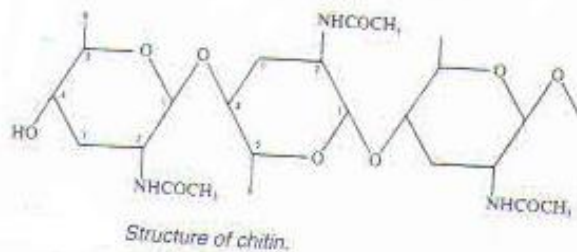

2. SUGAR DERIVATIVES

Some compounds contain sugar molecules linked with other non-sugar compounds, such compounds are called sugar derivatives. Some of these are described below;

- a. **Mucopolysaccharides.** These are formed from amino sugars e.g. glucose amine. An amino sugar is a sugar containing nitrogen. Examples of mucopolysaccharides include the following;
 - i. ***Hyaluronic acid:*** this forms part of the vertebrate connective tissues. It is therefore found in cartilage, bones, vitreous humor of the eye and in the synovial fluid. Hyaluronic acid is also found in anti-coagulant called ***heparin.***
 - ii. Other mucopolysaccharides are mainly found in the cell walls of prokaryotes such as bacteria.
- b. **Nucleotides.** A nucleotide is where pentose sugars join with organic bases. Nucleotides are the basic building blocks of nucleic acids such as DNA on which heredity depends and RNA on which protein synthesis depends. Other nucleotides are mainly used in respiration and these include Adenosine Tri Phosphate (ATP), Nicotinamide Adenine Dinucleotide (NAD), and Flavine Adenine Dinucleotide (FAD).

3. **Inulin** is an unbranched chain of fructose with 1-2 glycosidic bonds found as a storage carbohydrate in some plants
4. **Chitin** is an unbranched chain of β -acetylglucosamine units with 1-4 glycosidic bonds
5. **Lignin** is chemically, it resembles mucopolysaccharides. It is a polymer formed from sugars and amino acids. It is rigid involving chain molecules which are condensed and it binds cellulose chains to form microfibrils.

Lignin impregnates the cell walls of water transporting tubes (xylem) to form an impermeable lining, a process called lignification.

It also prevents rot, infections and decay.

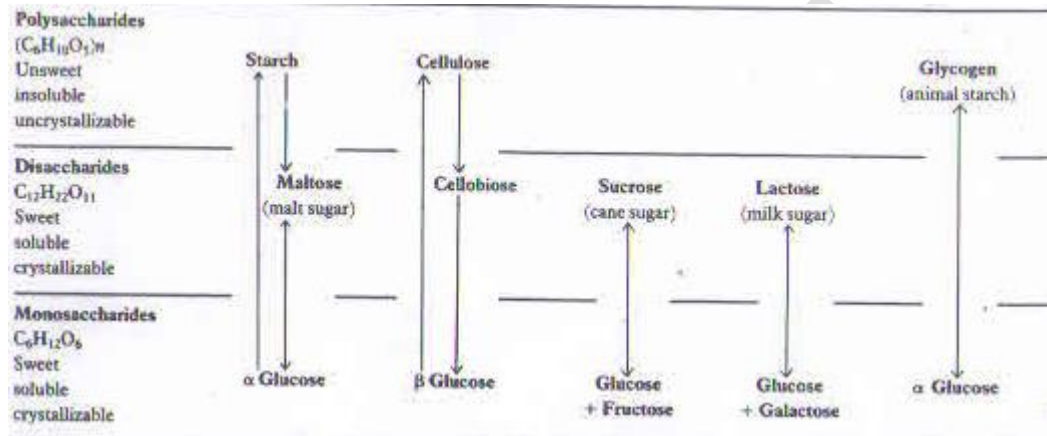

Carbohydrates have a variety of structural features which account for the wide variety of polysaccharide formed and these include:

- Both pentoses and hexoses can be used to make polysaccharides though normally one type of monosaccharides is used in each polysaccharide type like hemicellulose, nucleic acid sugars may be aldoses and ketoses.
- Capacity to form 1, 4 and 1, 6 glycosidic bonds are common between sugar units e.g in cellulose. This accounts for the case of branching and hence formation of different types of polysaccharides.
- Capacity to form chains of various length and branching
- Existence of alpha and Beta forms of monosaccharide account for the variation of polysaccharides e.g. starch, alpha glucose monosaccharide while cellulose made of beta glucose units.
- Sugars may be Ketoses or aldoses, these increase the polysaccharide variation like inulin is made of Ketose monosaccharide units while starch and glycogen are made of aldose monosaccharide units.
- The high chemical reactivity of sugar and OH groups and their variation in exposure increases polysaccharide variability.

Main functions of carbohydrates

- They are a primary source of energy being oxidized in the body to release energy.
- They are structural components of cells e.g. cellulose making up the cell wall.
- They are determinants of osmotic potential of body fluids therefore maintain blood pressure.
- They are recognition units on the surface of body cells i.e. they are component structures of the surface cell membranes recognized by antibodies.

- Energy stores/ food stores in form of starch and glycogen

Chemical tests for polysaccharides

Starch

The iodine test is the standard test for starch. Addition of Iodine to a starch containing substance results to a blue-black colour and absence of starch is manifested by the colour of Iodine remaining unchanged.

Cellulose

The chemical test for cellulose is using the **Schultz solution** which when added to a cellulose containing substance turns **violet** in colour. An alternative test would be **conc. Sulphuric acid and Iodine solution** and if the substance contains cellulose, an **intense blue colour** is observed.

LIPIDS (fats and oils)

Lipids are natural fats and oils made up of carbon, hydrogen and oxygen but the ratio of hydrogen to oxygen is not 2:1 as in carbohydrates instead the hydrogen atoms are far more than the oxygen atoms. All lipids have a high proportion of hydro carbon group (CH₂) in their molecules. They are insoluble in water but can dissolve in organic solvents such as chloroform, benzene, acetone, alcohols e.t.c. The low solubility of lipids is due to the low oxygen content and very many CH₂ groups, the numbers of polar -OH groups that are present in the molecule are very few thus preventing dissolving. It is these polar groups that normally confer solubility in water (H₂O) through ion interaction with water in the case of carbohydrates.

Fats are solids at room temperature whereas oils are liquids. Lipids also include **waxes, steroids** and phospholipids.

CONSTITUENTS OF LIPIDS

Lipids are made up of **esters** called fatty acids and an alcohol of which glycerol is the most common.

Glycerol has three hydroxyl groups (-OH) and each of these may combine - with separate fatty acids forming **triglyceride**. This combination occurs by **condensation reaction** in which three water molecules are formed and therefore the hydrolysis of the triglyceride will again yield glycerol and 3 fatty acids.

Fatty acids have a general formula of C_nH_{2n}O₂. Their structural formula can be summarized as below R(CH₂)_nCOOH. Where n is any even number between 4 and 24. R can be CH₃CH₂, CH₃CH₂CH₂ e.t.c.

Fatty acids can be classified as **unsaturated** if they contain one or more double bonds e.g. oleic acid. Fatty acids lacking double bonds are said to be **saturated** e.g. stearic acid. Unsaturated fatty acids melt at a much lower temperature than saturated fatty acids. Consequently, saturated fatty acids are normally found in fats while unsaturated fatty acids are commonly found in oils. Lipids vary due to the presence of many fatty acids.

<i>Fatty acids</i>	<i>Formula</i>	<i>Saturation</i>	<i>Sources</i>
Linolenic acid	C ₁₇ H ₃₁ COOH	Unsaturated	Vegetable oil
Linoleic acid	C ₁₇ H ₃₁ COOH	Unsaturated	Sunflower oil
Oleic acid	C ₁₇ H ₃₃ COOH	Unsaturated	Olive oil

Fats differ from oils in two fundamental ways;

- Fats are made from saturated fatty acids while oils are made from unsaturated fatty acids.

Palmitic acid	C ₁₅ H ₃₁ COOH	Saturated	Palm oils
Stearic acid	C ₁₇ H ₃₅ COOH	Saturated	Adipose fats
Arachidonic acid	C ₁₉ H ₃₁ COOH	Unsaturated	Meat, eggs, fish
Lauric acid	C ₁₁ H ₂₃ COOH	Saturated	Coconut oil

b) Fatty acids in oils are smaller than those in fats.

<p>GLYCEROL (Propan-1, 2, 3-triol)</p> <p>This is an alcohol with the molecular formula of C₃H₈O₃. There is only one type of glycerol that exists in both fats and oils whose structure is shown on the right</p>	$ \begin{array}{c} \text{H} \quad \text{H} \quad \text{H} \\ \quad \quad \\ \text{H}-\text{C}-\text{C}-\text{C}-\text{H} \\ \quad \quad \\ \text{OH} \quad \text{OH} \quad \text{OH} \end{array} $
--	--

FORMATION OF A TRIGLYCERIDE

During its formation, a *condensation reaction* occurs in which 3 fatty acids of the same type or different types, combine with one glycerol molecule. During this reaction, the hydroxyl group of glycerol reacts with a carboxyl group (COOH) of the fatty acids to form water and *triglyceride* joined by ester bonds as illustrated on the right;

- a) Because fatty acids are synthesized from fragments containing two carbon atoms, the number of carbon atoms in the lipid chains is always an even number.
- b) Lipids require too much oxygen to be oxidized in respiration as compared to glycogen and are therefore used in respiration.

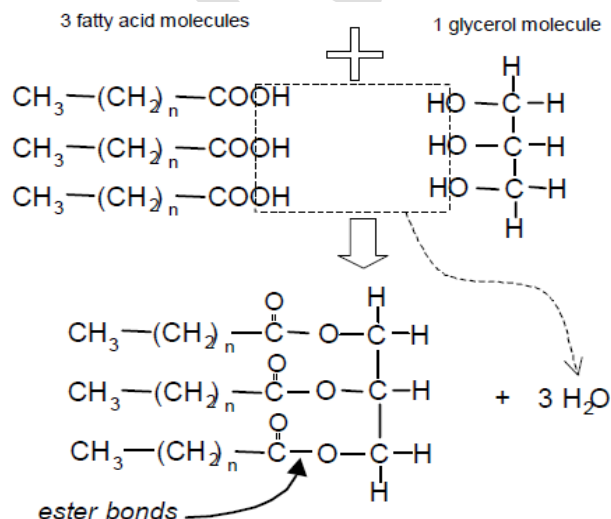

ESSENTIAL AND NON-ESSENTIAL FATTY ACIDS

The essential fatty acids are the ones which cannot be synthesized by the body and must therefore be obtained from the diet e.g. linoleic acid and linolenic acid. A common dietary source for these fatty acids which are essential in our bodies is vegetables and seed oils. Deficiency of essential fatty acids results into retarded growth or reduction in the growth rate, reproductive deficiency and even kidney failure.

STERIODS AND WAXES

<p>WAXES</p> <p>These are similar to lipids in composition except that the fatty acids are linked to long chained alcohols instead of glycerol. These form a water proof layer on the surfaces of most terrestrial plants and animals. They may also be used as a form of storage in a few compounds such as castor oil and in fish.</p>	<p>STERIODS</p> <p>These are lipids whose molecules contain 4 rings of carbon and hydrogen atoms. Steroids are therefore bigger than the common lipids and they are saturated hydro carbons.</p>
---	--

The functions of some important steroids are given below;

STERIOD	FUNCTION
Cholesterol	It is a major component of the cell membrane. It is a raw material for many other steroids.
Bile acids (glycocholic acid and taurocholic acid)	These are used in emulsification of fats during digestion.
sex hormones a. Oestrogen and progesterone b. Testosterone	These are reproductive hormones in female mammals which regulate the menstrual cycle and controlling pregnancy This is a reproductive hormone in male mammals controlling sexual behavior and sperm production.
Vitamin D (Calciferol)	It promotes calcium and phosphate absorption and metabolism It is also important for the hardening of bones and teeth
Ecdysone (Moulting hormone)	It causes moulting (shedding off the cuticle in arthropods)

PHOSPHOLIPIDS

A phospholipid differs from having a phosphate group (PO_4^{3-}) group attached to one of the hydroxyl groups of glycerol such that they have two fatty acids linked to glycerol by condensation reaction instead of three fatty acids.

Other groups including nitrogenous bases could even be attached to this phosphate group to make the structure even more complex.

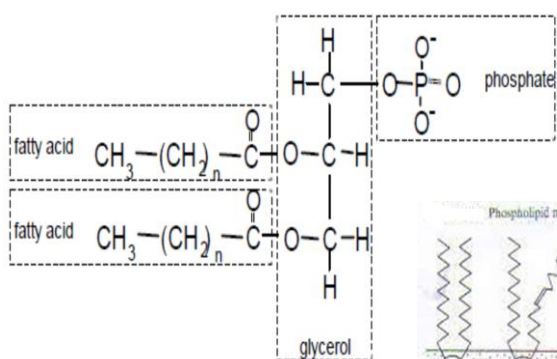

The phosphate group is electrically charged (PO_4^{3-}) and therefore polar and so unlike fatty acids dissolve in water. Phospholipids are therefore able to dissolve in both water and organic substances i.e. phospholipids are both hydrophilic and hydrophobic. This property of phospholipids is important in determining the structure and functioning of the cell membrane. In water, phospholipid molecules collect together in a single layer (monolayer) with the hydrophilic head poking into the water. In cells, both the intracellular environment and immediate external environment are watery. This causes phospholipids to form a double layer, with the hydrophobic tails pointing inwards, away from the watery environment. The phospholipids bilayer gives cell membranes their fluid properties and allows lipid soluble substances to pass easily through them

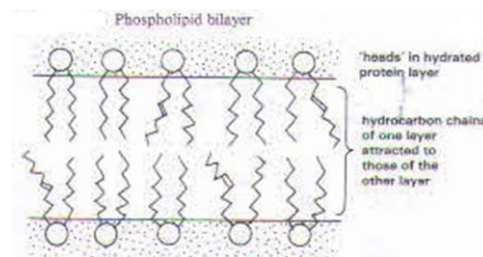
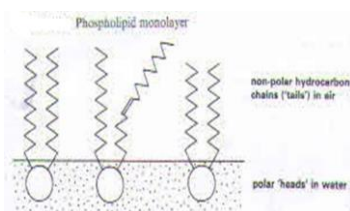

1. Glycolipids

They are lipids with a carbohydrate attached by a glycosidic bond. Their role is to serve as markers for cellular recognition. The carbohydrates are found on the outer surface of all eukaryotic cell membranes

2. Lipoproteins

This forms part of the cell membranes and it is the chemical form in which lipids are transported.

3. Steroids

These are lipids whose molecules contain 4 rings of Carbon and Hydrogen atoms. Three of the rings are six numbered and one of them is five numbered. All together there are 17 carbon atoms, six of which are shared between the rings and they are saturated hydrocarbons. They cannot be hydrolysed. Some are formed by the smooth ER of cell membranes

Functions of lipids

1. An energy source.

Lipids store more energy than similar quantities of carbohydrates. Upon hydrolysis lipids yield more energy than carbohydrates i.e. lipids yield 38KJg^{-1} of energy compared to 17KJg^{-1} for the carbohydrates. This is so because of many covalent bonds of carbon to carbon (C-C) and carbon to hydrogen (C-H) type that are present in lipids due to many hydrogen atoms they contain. These bonds contain large quantities of energy that can be released and used by the cell when required.

Therefore carbohydrates yield less energy for the cell but are readily hydrolysed than lipids.

2. Storage of materials

Lipids are good storage compounds in the body e.g. they store a lot of water and fat soluble vitamins e.g. A, D, E and K. Lipids are good storage compounds because of the following reasons;

- They are insoluble in water and therefore cannot dissolve away and cannot affect the osmotic potential of the cells
- They are much lighter than carbohydrates so as to keep the weight to the minimum
- They have a high calorific value i.e. they have a high energy content
- They are compact and therefore they take up very little space in the cells
- Lipids are poor conductors of heat in the body

3. Lipids insulate the body against heat loss as they are poor conductors of heat. This explains why the major fat deposits of the body are found under the skin as subcutaneous fat layer, and around vital organs such as the heart, kidneys, lungs, intestines e.t.c. whose temperatures should not vary much. Aquatic mammals, e.g. whales, seals and manatees, have an extremely thick subcutaneous fat, called blubber, which forms an effective insulator.

4. Fats are used as packing material around delicate organs of the body such as kidneys, heart, lungs and intestines so as to protect them from physical damage by acting as shock absorbers.

5. Lipids speed up impulse transmission along nerves using the myelin sheath

6. Lipids are useful source of metabolic water for desert animals when broken down in respiration

7. Plant scents are fatty acids or their derivatives and so aid in the attraction of pollinators

8. Lipids form very important structures in organisms, the structures include;

- They form the phospholipid layer of the cell membrane by combining with phosphorous to form the phospholipids
- They form the subcutaneous fat layer beneath the dermis of the skin
- They form the waxy cuticle of the insects and plants which prevent excessive water loss
- They form the adipose tissue usually around the delicate organs such as the heart
- They form suberin in plant cell walls especially in endoderm cells
- Bees use wax in constricting their honey combs

PROTEINS

Proteins are complex organic compounds with a large molecular mass made of small units called **amino acids**. Amino acids consist of carbon, oxygen, hydrogen, nitrogen and in some cases sulphur. They are not truly soluble in water, but form colloidal suspensions. Proteins are rarely stored by organisms except in eggs or seeds where they are used to form the new tissue. The variety of proteins is unlimited because the sequence of amino acids in each protein molecule which is genetically determined by DNA within cells during protein synthesis.

Proteins are the most abundant molecules to be found in the cells and comprise over 50% of their total dry weight. They are therefore an essential component of the diet of animals and may be converted to both fats and carbohydrates by the cells. All proteins are composed of basic structural molecules known as **amino acids**.

AMINO ACIDS

There are 20 common naturally occurring amino acids whose different combinations result in a great variety of the proteins since each amino acid has its own set of properties. The general formula of amino acids is RCHNH₂COOH whose structure is shown below;

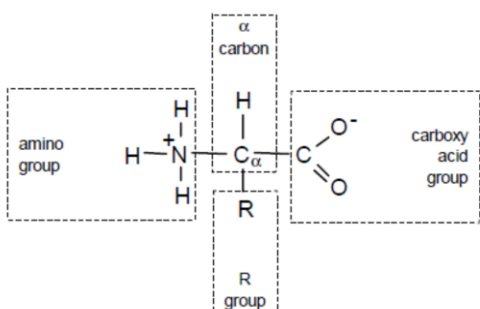

The structure shows that amino acids are composed of four different parts namely;

1. A hydrocarbon group (-CH)
2. A carboxyl group (COOH)
3. An amino group (NH₂)

4. An R group. It is in this R group of the amino acid that lies the difference in the amino acid e.g. in amino acids, glycerine which is the simplest amino acid, R is a hydrogen atom while it's a methyl group (CH₃) in amino acid alanine.

Amino acids are soluble in water but insoluble in organic solvents. At neutral pH (found in most living organisms), the groups are ionized as shown above, so there's a positive charge at one end of the molecule and a negative charge at the other end. The overall net charge on the molecule is therefore zero.

The presence of an amino group which is **basic** and a carboxyl group which is **acidic** in all amino acids accounts for the name amino acids and also confer on the amino acids on **amphoteric** nature i.e. amino acids have both acidic and basic properties. This implies that amino acids can donate hydrogen ion (protons) as acids do and also can accept hydrogen ions (protons) as bases do. In amino acids, these abilities to donate or receive protons are conferred by a carboxyl and amino groups respectively.

Their amphoteric nature is useful biologically as it means that they can act as **buffers** in solutions thereby resisting changes in the pH of the solution. A buffer solution is the one which is able to resist changes in the pH of the solution. Amino acids therefore can donate hydrogen ions as the pH increases so as to lower the pH and also accept hydrogen ions from the solution as the pH decreases so as to raise the pH. Amino acids therefore play an important role as buffer in the tissue fluid and in the cytoplasm of most cells thereby maintaining the pH within the narrow limits needed for normal metabolism and efficient enzyme functioning. This is because changes in pH denature enzyme which can be fatal to the living organism.

The charge on the amino acid changes with pH as shown below;

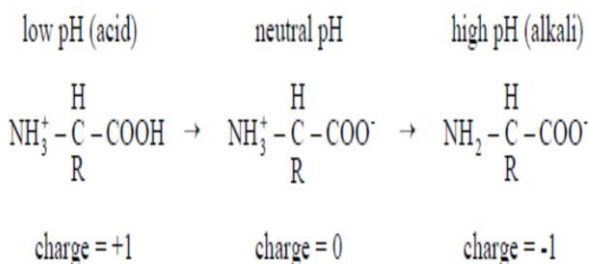

It's these changes with change in pH, that explain the effect of pH on enzymes. A solid, crystallised amino acid

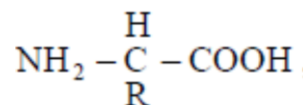

has the uncharged structure, but this form never exists in solution, and therefore doesn't exist in living things (although it is the form given in most text books)

AMINO ACIDS AND DIET

Amino acids are classified into two groups namely; essential and non-essential amino acids.

Essential amino acids

These are the amino acids which cannot be synthesized by the body and therefore must be obtained from the diet.

These amino acids include the following

1. Isoleucine
2. methionine
3. tryptophan
4. Leucine
5. threonine
6. valine
7. Lysine
8. phenyalanine
9. arginine
10. histidine

Foods containing all the essential amino acids are known as **first class protein food** and such foods include all animal proteins and some few plant proteins e.g. the soya bean. Food lacking one or more essential amino acids is known as **second class protein food** and this includes most plant proteins and a few animal proteins.

FORMATION OF A POLYPEPTIDE

Initially two amino acids are united in a condensation reaction to form a dipeptide with the loss of a water molecule. Later several dipeptides combine in several condensation reactions to form polypeptides which consist of up to 500 amino acids or more. The individual amino acids within the polypeptide chain are linked by peptide bonds to form a protein.

These polypeptides made are then folded and twisted in an appropriate way as directed by a particular gene (DNA) which also determines the sequence of amino acids in the chain. This is illustrated on the right

The non-essential amino acids. These are amino acids which the body can synthesise in such sufficient quantities for them not to be required in the diet. The absence of one or more of these amino acids results in retarded growth and particular symptoms, characteristics of the particular amino acid lacking. Non-essential acids include the following

1. Alanine
2. Glycine
3. Cysteine
4. Aspartic acid
5. Proline
6. Asparagine
7. Glutamic acid
8. Serine
9. Glutamine
- 10.

Non-essential amino acids are synthesised in the body through a process known as **transamination** which involves the use of enzymes known as **transaminases**, the raw materials for this process are the essential amino acids provided in the diet and carbon dioxide derivatives e.g. pyruvic acid which is obtained from the breakdown of sugar during respiration

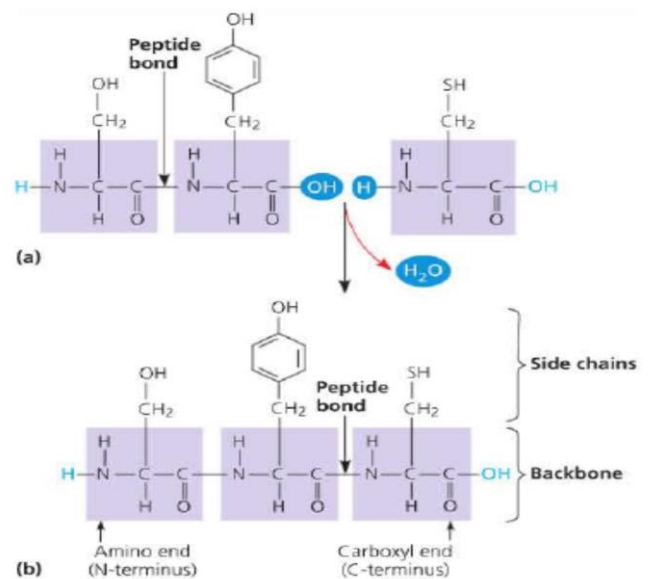

Amino acids are able to form other bonds with reactive groups apart from the peptide bond. Such bonds include the following;

1. the ionic bond

At a suitable pH an interaction may occur between ionised amino groups and a carboxyl and this result into the formation of an ionic bond between the two amino acids. This bond can be easily broken in an aqueous medium by changing the pH of the medium.

2. the disulphide bond

This bond arises between sulphur containing groups of any two oxidised cysteine molecules of amino acids. Disulphide bonds may be formed between different parts of the same chain (hence folding the chain into a particular structure) or different chains of amino acids. They are strong and not easily broken.

hydrogen bond is weak, but as its occurrence is more frequent, the total ϵ contribution towards molecular stability, as in the structure of the α -helix.

4. Hydrophobic interaction

Within a polypeptide chain, hydrophobic interactions or bonds can be registered. They arise in situations where the R-groups are non-polar and therefore hydrophobic. The polypeptide chain will tend to fold so that the maximum number of hydrophobic groups come into close contact and exclude water. This is how many globular proteins fold up. The hydrophobic groups tend to point inwards towards the centre while the hydrophilic groups face outwards in the aqueous environment making protein soluble. They are also weak bonds.

All the three types of bonds above are shown in the image above;

CLASSIFICATION OF PROTEINS

Proteins are classified according to their orders of organization, particularly of the amino acids within the peptide chains. The proteins are also classified as primary structure proteins, secondary, tertiary and quaternary structure proteins.

PRIMARY STRUCTURE

This refers to the sequence of amino acids found in the polypeptide chains of the proteins. This sequence determines the properties and shape of the proteins. The primary structure is specific for each protein and is determined by the DNA of the cell from which it is made.

A primary structure is held together by the covalent bonds called peptide bonds between adjacent amino acids. All other protein structures are modifications of these primary structures.

One major importance of the primary structure of the protein in relation to function is found in **enzymes**, in which the structural configuration of the active site of the enzymes determines whether a particular substrate will fit in the active site of that enzyme.

The primary structure is clearly shown by insulin hormone.

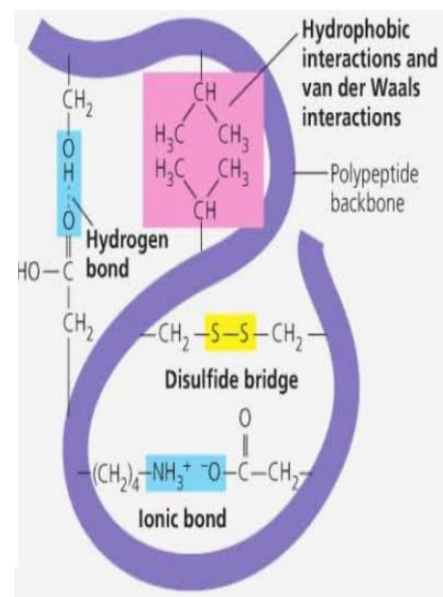

SECONDARY STRUCTURE

This refers to the regular arrangement of the polypeptide chains of the proteins as a result of hydrogen bonding which can be either **alpha-helix** or **beta-pleated sheets**. This is because after their formation, the chain of amino acids in the polypeptide folds spontaneously to make complex configurations categorised into alpha-helices or beta-pleated sheets held together by hydrogen bonds.

An alpha-helix is the one in which the polypeptide chain is loosely coiled into a regular spiral shape joined by numerous hydrogen bonds. It is regular in that the repeating constituents of the polypeptide backbone in the spirals are at a specific distances. The β -pleated sheets are chains of polypeptides arranged in a zigzag format with antiparallel strands held together by hydrogen bonds.

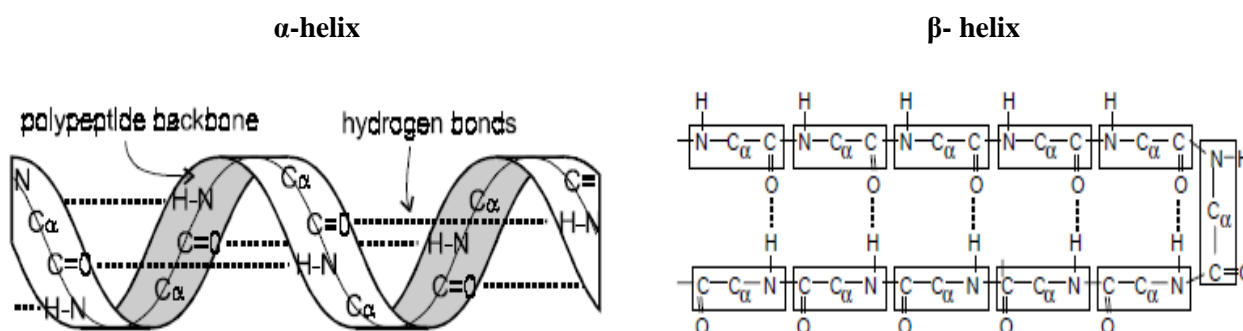

The hydrogen bonds stabilise the helix by joining together the amino group of one turn and a carboxyl group of another turn. Therefore, the importance of the secondary structure is that it maintains a particular shape of a protein keeping it stable by twisting it.

This secondary structure is of greater importance in the biological function of proteins particularly **enzymes** and **antibodies** whose efficiency depends on maintaining a particular shape. It is also important in the formation of fibrous proteins which are insoluble in water and are resistant to changes in temperature and pH.

The secondary structure of a protein is of particular importance in the formation of **structural proteins** such as keratin, silk and collagen. Keratin is a **fibrous protein** found in the hair, nails, horns, feathers and wool. Collagen is also a **fibrous protein** found in mammalian connective tissue such as bones, cartilage, tendons and the skin. Both keratin and collagen contain a secondary structure in the form of an alpha-helix.

TERTIARY STRUCTURE

This is a structure resulting from other uniform coiling and folding of the polypeptide helix in to a very compact structure.

For this to happen all the three types of bonds namely, ionic, hydrogen and disulphide bonds must be present in the protein so as to contribute to the maintenance of the structure. It is the structure which explains the complex molecular shape of some proteins especially **globular proteins**, especially enzymes, myoglobin and insulin.

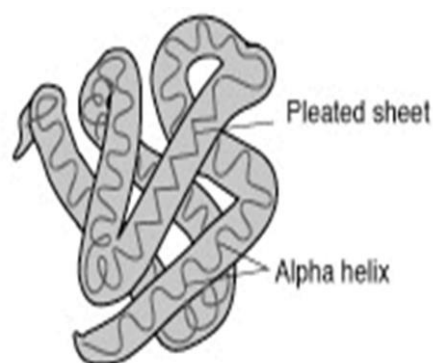

This structure contains many cross linkages formed by many bonds within the polypeptide chains which make the proteins strong molecules.

These are soluble in water because they consist of polar groups and amino acids which congregate outside and interact with water. There hydrophobic chains contain non polar amino acids and are usually pushed inwards into the centre of the molecules.

QUATERNARY STRUCTURE

This is the structure which arises from the combination of a number of different polypeptide chains and associated non protein groups into a large protein molecule. Such a structure is shown by haemoglobin.

Structurally haemoglobin consists of 2 α -polypeptide chains and 2 β -polypeptide chains arranged around a complex ion containing prosthetic groups called haem groups. Such polypeptide chains are normally fitted together in such a way that they form larger and more complex protein structure.

The 4 polypeptide chains in haemoglobin are called globin. Each chain in haemoglobin carries a haem group to which one molecule of oxygen bonds.

The structure of haemoglobin is shown below;

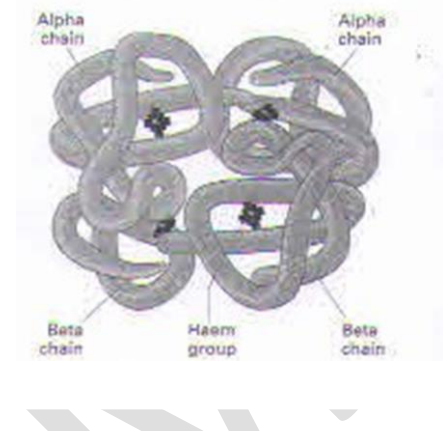

Structural Level	Characteristics
Primary	The sequence of amino acids
Secondary	The coiled α helix, β -pleated sheet, or a triple helix form by hydrogen bonding between peptide bonds along the chain
Tertiary	A protein folds into a compact, three-dimensional shape stabilized by interactions between R groups of amino acids
Quaternary	Two or more protein subunits combine to form a biologically active protein

Proteins are classified into two main groups on the basis of their tertiary structure

- Fibrous proteins.** These have a primary structure of regular repetitive sequences. They form long chains which may run parallel to one another, being linked by cross bridges. They are very stable molecules and have structural roles with organisms e.g. collagen.
- Globular proteins.** They have irregular sequences of amino acids in their polypeptide chains. They are compact and are far less stable and have metabolic roles within organisms. All enzymes are globular proteins.
- Conjugated proteins.** These are proteins with other chemicals incorporated within their structure and the non-protein part is referred to as the prosthetic group. If the prosthetic group in a protein is organic in

Examples of conjugated proteins		
Name of protein	Location	Prosthetic group
Haemoglobin	Blood	Haem (containing iron)
Mucin	Saliva	Carbohydrate
Casein	Milk	Phosphoric acid
Cytochrome oxidase	Electron carrier pathway of cells	Copper
Nucleoprotein	Ribosomes	Nucleic acid

Comparison of globular proteins and fibrous proteins	
Fibrous proteins	Globular proteins
Repetitive regular sequence of amino acids	Irregular amino acid sequence
Actual sequence may vary slightly between two examples of the same protein	Sequence highly specific and never varies between two examples of the same protein
Polypeptide chains form long parallel strands	Polypeptide chains fold into a spherical shape
Length of chain may vary between two examples of the same protein	Length always identical in two examples of the same protein
Stable structure	Relative unstable
Insoluble	Soluble
Support and structural functions	Metabolic functions
e.g. collagen and keratin	e.g. enzymes, hormones and haemoglobin

CHARACTERISTICS OF PROTEINS

1. They are colloidal in nature

In solution, proteins form colloids since they have large sizes, they do not go into true solutions but form colloidal suspensions. A colloidal is a particle which remains suspended in solution rather than dissolving, settling down or floating. I.e. too small to settle out under gravity but also too large to dissolve.

The importance of colloids being dispersed in solution is that it gives them a large surface area which makes them very reactive. This is important in enzymes.

2. They have amphoteric properties

Proteins are amphoteric i.e. they have basic and acidic properties. The basic and acidic properties.

3. They are made of large molecules

4. They show specificity e.g. in enzymes which are specific in nature

5. On hydrolysis, they yield a mixture of amino acids.

6. They are insoluble in organic solvents.

Protein denaturation

The three-dimensional structure of a protein is, in part at least, due to fairly weak ionic and hydrogen bonds. Any agent which breaks these bonds will cause the three-dimensional shape to be changed. In many cases, the globular proteins revert to a more fibrous form. This process is called **denaturation**. The actual sequence of amino acids is unaltered; only the overall shape of the molecule is changed. This is still sufficient to prevent the molecule from carrying out its usual functions within an organism. Denaturation may be temporary or permanent and is due to a variety of factors as shown in the table below;

Factor	Example	Explanation
Heat	Coagulation of albumen (boiling eggs makes the white more fibrous and less soluble)	Causes the atoms of the protein to vibrate more due to increased kinetic energy, thus breaking the hydrogen and ionic bonds

Acids	The souring of milk by acid e.g <i>Lactobacillus</i> bacterium produces lactic acid, lowering the pH and causing it to denature the casein, making it insoluble and thus forming curds	Additional H ⁺ ions in acids combine with COO ⁻ groups on amino acids and form COOH, ionic bonds are hence broken.
Alkalis		Reduced number of H ⁺ ions causes NH ₃ ⁺ to lose H ⁺ ions and form HN ₂ , hence ionic bonds are broken.
Inorganic chemicals	Many enzymes are inhibited by being denatured in the presence of certain ions, e.g. cytochrome oxidase (respiratory enzyme) is inhibited by cyanide.	The ions of heavy metals such as mercury and silver are highly electropositive. They combine with COO ⁻ groups and disrupt ionic bonds. Similarly, highly electronegative ions e.g. cyanide (CN ⁻), combine with NH ₃ ⁺ groups and disrupt ionic bonds.
Organic chemicals	Alcohol denatures certain bacterial proteins. This is what makes it useful for sterilization.	Organic solvents alter hydrogen bonding within proteins.
Mechanical force.	Stretching hair breaks the hydrogen bonds in the keratin helix. The helix is extended and hair stretches. If released, the hair returns to its normal length. If, however, it is wetted and then dried under tension, it keeps its new length- the basis of hair styling.	Physical movement may break hydrogen bonds.

Renaturation

This is the reconstruction of a protein that has been denatured to a small extent such that its molecules regain the original 3-dimensional configuration and function by providing them with the ideal conditions of mainly the pH, and temperature. If the degree of denaturation is great, renaturation cannot take place even if the ideal conditions are provided.

Functions of proteins

Vital activity	Protein function	Function
Nutrition	Digestive enzymes, e.g. trypsin	Catalyses the hydrolysis of protein to polypeptides
	Amylase	Catalyses the hydrolysis of starch maltose
	Lipase	Catalyses the hydrolysis of fats to fatty acids and glycerol
	Fibrous proteins in granal lamellae	Help to arrange chlorophyll molecules in a position to receive maximum amount of light for photosynthesis
	Mucin	(1) Assists trapping of food in filter feeders. (2) Prevents autolysis. (3) Lubricates guts wall.
	Casein	Storage protein in milk

	Ovalbumin	Storage protein in egg white
Respiration and transport	Haemoglobin/ haemoerythin/ haemocyanin/ chlorocruorin	Transport of oxygen
	Myoglobin	Stores oxygen in muscle
	Prothrombin/fibrinogen	Required for the clotting of blood
	Mucin	Keeps respiratory surface moist
	Antibodies	Essential to the defence of the body, e.g. against bacterial invasion
Growth	Hormones, e.g. thyroxine	Controls growth and development
Excretion	Enzymes, e.g. urease, arginase.	Catalyses reactions in the ornithine cycle thus useful in protein breakdown and urea formation
Support and movement	Actin/myosin	Needed for muscle contraction
	Ossein	Structural support in bones
	Collagen	Gives strength with flexibility in tendons and cartilage
	Elastin	Gives strength and elasticity in ligaments
	Keratin	Tough for protection, e.g. in scales, claws, nails, hooves, skin.
	Sclerotin	Provides strength in insects exoskeleton
	Lipoproteins	Structural components of all cell membranes
Sensitivity and coordination	Hormones, e.g. insulin/glucagon, adrenocorticotrophic hormone, vasopressin	Controls blood sugar level Controls the activity of the adrenal cortex Controls blood pressure
	Rhodopsin/opsin	Visual pigments in the retina, sensitive to light
	Phytochromes	Plant pigments important in control of flowering, germination, e.t.c.
Reproduction	Hormones e.g. prolactin	Induces milk production in mammals
	Chromatin	Gives structural support in chromosomes
	Gluten	Storage protein in seeds, nourishes the embryo
	Keratin	Forms horny and antlers which may be used for sexual display

CLASSIFICATION OF PROTEINS ACCORDING TO FUNCTIONS

- 1. Enzymes.** These are biological catalysts which control chemical reactions in organisms e.g. amylase
- 2. Structural proteins.** These form part of the body of organisms e.g. collagen which makes up tendons and ligaments. Keratin is a major component of hair and nails
- 3. Signal proteins.** These carry messages around the body e.g. insulin hormone and glucagon involved in controlling glucose levels in blood
- 4. Contractile proteins.** These are involved in movement after contraction e.g. actin and myosin which are proteins that aid muscle contraction

5. **Storage proteins.** These keep materials e.g. albumen in the egg which nourishes the chick while it is still inside the egg.
6. **Defensive proteins** such as antibodies, thrombin, fibrinogen which are important for fighting infections.
7. **Transport proteins** e.g. haemoglobin which carries oxygen around the body

ENZYMES

An enzyme is an organic catalyst protein in nature which speeds up the rate of metabolic reactions in an organism without itself undergoing a permanent change.

Without enzymes the reactions that occur in living organisms would proceed so slowly, if at all, to cope up with the rates required for maintenance in life. Also increasing the rate of a body reaction would be by increasing the temperature of the body. This would denature proteins, disrupt membranes and be very expensive in terms of energy expenditure. Enzymes therefore enable metabolic reactions to proceed rapidly and at low temperatures.

Enzyme reactions may be described as either *catabolic*, if they are involved in the breakdown of compounds or *anabolic*, if they are involved in the synthesis of compounds. The total of all catabolic and anabolic reactions in a living cell or organism is what is called *metabolism* of the cell or organism.

THE CONTROL OF METABOLIC PATHWAYS

Commonly a number of enzymes are used in sequence to convert one substance into one or several products via a series of intermediate compounds. The chain of reactions involved in converting the substrates to their products through a series of intermediate compounds i.e. known as the metabolic pathway.

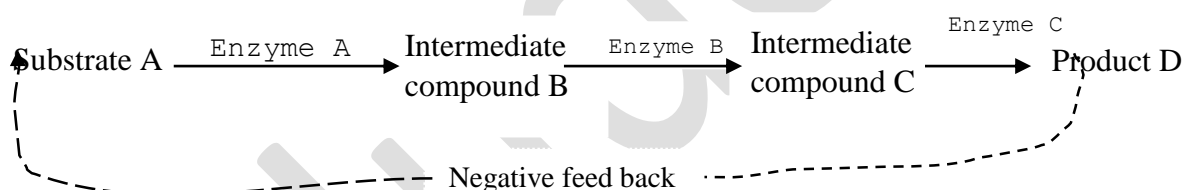

Many such pathways can proceed simultaneously in a single cell. The reactions proceed in an integrated and controlled way and this can be attributed to the specific nature of enzymes.

A single enzyme will catalyse only a single reaction, therefore enzymes serve to control the chemical reactions that occur within the cells and ensure that these reactions proceed at an efficient rate. The cells also make use of the properties of enzymes to exercise control over metabolic pathways as illustrated in the example above. The high concentration of the end product of the pathway may inhibit the enzyme at the start of the pathway this is called *end product inhibition*.

In the example illustrated above, end product D acts as an inhibitor to enzyme A. If the level of product D falls, this inhibition is greatly reduced and so more of substrate A is converted to B, more of B is converted to C, and finally more of C is converted to D. If the level of end product D rises above normal, inhibition of enzyme A increases greatly and so the level of D is reduced. This is because substrate A will no longer be converted to intermediate compound B. In this way homeostatic control of D is achieved. The mechanism is termed as **negative feedback** because the information from the end of the pathway which is feedback to the start of the pathway has a negative effect i.e. a high concentration of product D reduces its own production rate.

Control of the metabolic pathways has the following advantages;

- It allows energy to be derived in usable form from many small catabolic reactions than it would be in a single large reaction.
- It allows substrates to be partially broken down so as to provide raw materials for other reactions in the cell. Some of the intermediate compounds formed in the pathway have increased functions to perform within the cell.
- It allows the synthesis of complex organic compounds from simple raw materials using the genetic conditions prevailing in the cells which would not be synthesized in one step pathway.
- It increases the ability of the cell to control the products made in anabolic pathways when the reactions in them proceed in small steps.

CLASSIFICATION OF ENZYMES

TYPES OF ENZYMES

An enzyme name is based on two criteria;

<p>a. The name of the substrate acted upon by the enzyme e.g. succinate dehydrogenase acts on succinic acid.</p> <p>In most cases an enzyme is named by attaching the suffix “ase” to the name of the substrate on which it acts for example; (1) Proteins to protease (2) Lipids to lipase (3) Maltose to maltase (4) Sucrose to sucrase</p>	<p>b. The type of the reaction it catalyses e.g. dehydrogenation, hydrolysis, polymerization, decarboxylation e.t.c.</p> <p>(1) DNA polymerase which catalyze the formation of DNA by polymerization of DNA nucleotides</p> <p>(2) RNA polymerase which catalyses the formation of RNA by polymerization of RNA nucleotides.</p> <p>(3) Cytochrome oxidase catalyses oxidation reactions of cytochrome proteins</p>
<p>However, enzymes like Pepsin and Trypsin do not follow this naming convention</p>	

THE STRUCTURE AND MECHANISM OF ACTION OF ENZYMES

ENZYME STRUCTURE

Structurally an enzyme is a complex three dimensional *globular protein* some of which have other associated molecules.

Even though the enzyme molecule is normally larger than the substrate molecule it acts upon, only a small part of the enzyme molecule actually comes into contact with the substrate. This region of the enzyme molecule which comes into contact with the substrate is called the *active site*.

Only a few of the amino acids of the enzyme molecule actually make up the specific sequence of amino acids that make up the active site. The rest of the amino acids in the enzyme molecule are used to maintain the globular structure of the enzymes.

ENZYME GROUP	TYPE OF REACTION CATALYSED	EXAMPLES
Oxido reductase	These catalyse the transfer of oxygen and hydrogen atoms between substances i.e. they catalyse redox reactions	Oxidase Reductase
Transferases	These catalyse the transfer of one chemical group from one substance to another.	Transaminases Phosphorylase
Hydrolases	These catalyse hydrolysis reactions	Lipases Peptidases Phosphatases
Lyases	These catalyse the addition or removal of a chemical group other than hydrolysis.	Decarboxylases
Isomerase	These catalyse the re-arrangement of groups within a molecule. In other words it converts one isomer into another	Isomerase Maltase
Ligases	This catalyses the formation of bonds between two molecules using energy derived from the breakdown of ATP	Synthetases

The specific sequence of amino acids in the active site gives the active site of a **specific configuration**. It is the active site configuration which controls enzyme functioning and properties. It is at the active site that bonding of substrates occurs.

THE MECHANISM OF ENZYME ACTION

Enzymes generally work by lowering the activation energy. Enzymes therefore make it easier for a reaction to take place than it would without them.

How an enzyme lowers activation energy of the reaction is explained by a number of mechanisms described below;

THE LOCK AND KEY HYPOTHESIS

According to this hypothesis, enzymes have active sites into which specific substrate molecules fit exactly. The **substrate molecule is the key** whose shape is complementary to that of the enzyme active site

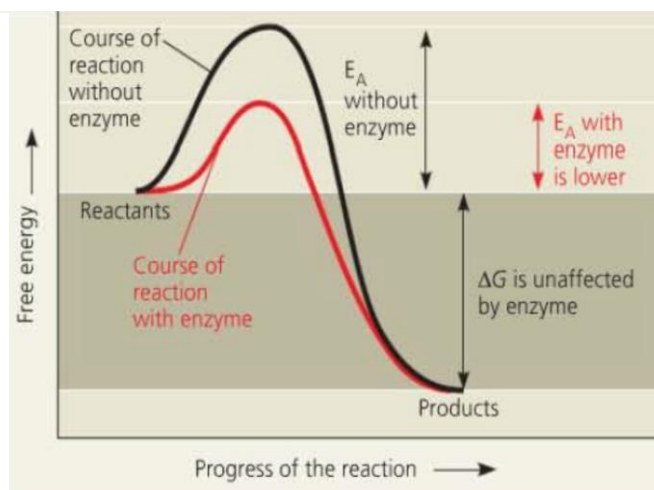

The **enzyme is the lock** where the substrate fits therefore both the enzyme and the substrate have the complementary structures.

The substrate molecules combine with an enzyme molecule to form a compound called **enzyme substrate complex**.

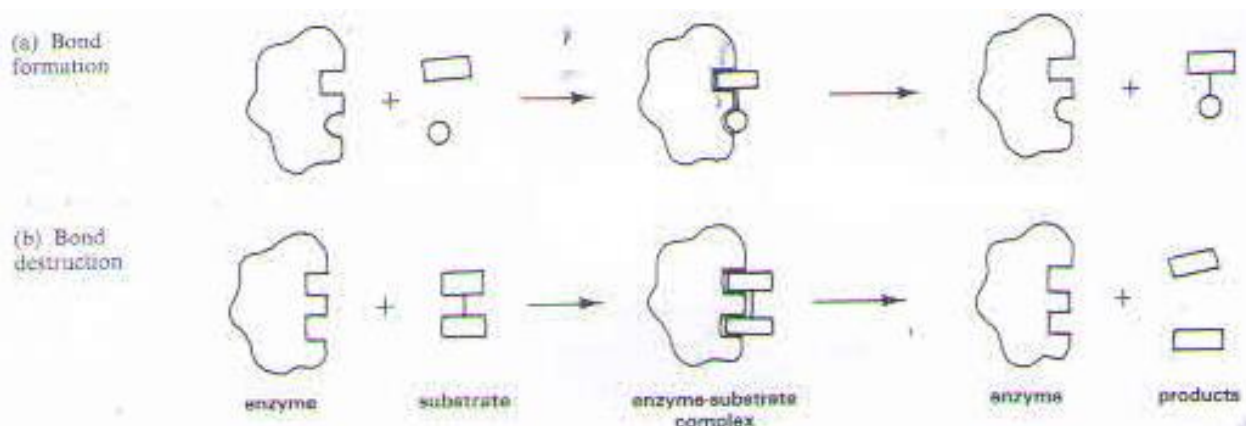

When the substrate binds with the enzyme molecule, the substrate molecules become slightly distorted putting a strain on the bonds of the substrate molecules which results into breaking of these bonds and rejoining them using less energy.

The enzyme-substrate molecule forms an enzyme-end product complex which splits into the enzyme and the end products. The enzyme remains unchanged while the products are released from the active sites since they have a different shape from the substrate.

The lock and key hypothesis is important in that it explains the various properties of enzymes in the following ways;

- It explains the specificity of enzymes because it shows that only substrates with complementary shapes to the active sites can actually fit into the active sites to form products.
- It explains how enzymes can be used over and over again. In other words, it shows that once the active site is set free at the end of the reaction, another substrate can combine with it to form an enzyme substrate complex.
- It explains why to some extent the rate, of an enzyme controlled reaction is limited by increasing the substrate concentration. This is so because the reaction is inhibited when all the active sites of an enzyme have been bonded to.
- It explains why and how enzymes can be inhibited this is because inhibitors having a similar shape to that of the active site of the enzyme may occupy the active site before the substrate and prevent the substrate from occupying the active site hence inhibiting the reaction.
- It further explains how heating lowers the rate of a controlled reaction. This is because heating denatures the enzyme their by changing its shape which prevents the substrate from fitting into the active site.
- Also changes in PH break the bonds which maintain the three dimensional shape of the enzyme and as a result change the active site configuration. This makes the substrate fail to fit through the active site.
- It explains why enzymes are protein in nature because the structure of proteins is based on a sequence of amino acids in their primary structures which sequence also exists in the active sites of enzymes thereby determining the properties of enzymes.
- It explains how enzymes reduce the activation energy of a chemical reaction by showing that when a substrate binds to the enzyme, substrate molecule becomes slightly distorted which strains the bonds in it and as a result less energy is needed to break the bond.

i)

THE INDUCED FIT HYPOTHEISIS

This alternative hypothesis is proposed in line with more recent evidence that the lock and key are not actually static but are able to change their shapes during combination so that the two fit each other properly .In the presence of the substrate, the active site of an enzyme may change in order to suit the shape of the substrate.

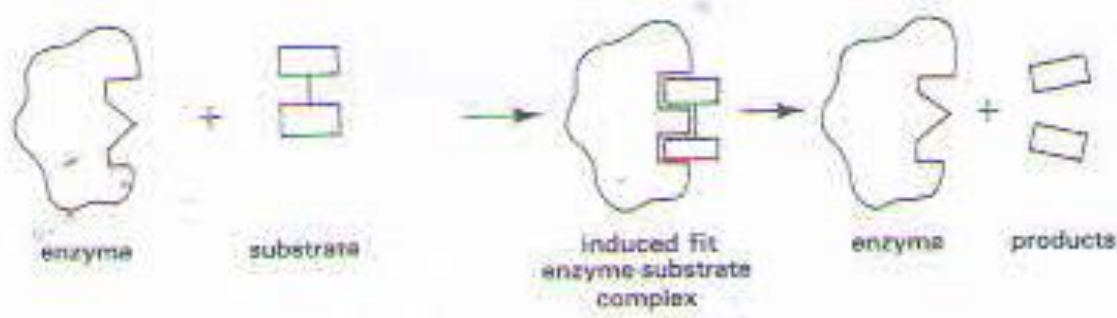

The enzyme in this hypothesis has a binding site configuration which attracts the substrate. On binding to the enzyme the substrate disturbs the shape of the active site and causes it to assume a new configuration. It is this new configuration which allows the substrate to suit properly in the active site and this enables the formation of an enzyme substrate complex in which the substrate molecules become slightly distorted. This strains the bonds in a substrate and as a result less energy is needed to break these bonds to form an enzyme product complex.

PROPERTIES OF ENZYMES

The properties of enzymes can be explained in relation to the lock and key hypothesis and the induced fit hypothesis. These properties include the following;

- a) They are protein in nature.
- b) They are all produced in living cells.
- c) They are soluble in water like any other globular proteins.
- d) They are not used up in the reactions they catalyse and therefore can be used over and over again.
- e) They work in very small quantities.
- f) They remain chemically unchanged by the reactions they catalyse.
- g) They are usually specific in their actions.
- h) They are denatured at higher temperatures beyond the optimum temperature and inactivated by lower temperatures.
- i) They are sensitive to change in pH. PH ranges out of the range in which enzymes work best denature enzyme and make them unable to catalyse reactions.
- j) They can work in either direction and this means that their reactions are reversible.
- k) Their reactions can be inhibited.
- l) They generally work very rapidly in their reactions. Their speed of action is known as the **turn over number** i.e. defined as the number of substrate molecules which molecules of an enzyme turn into products per minute. Some of the fastest enzymes are catalase (turn over number is 6 million) and carbonic anhydrase (turn over 36 million).
- m)

THE RATE OF ENZYME CONTROLLED REACTIONS

The rate of an enzyme controlled reaction is measured by the amount of substrate changed into products or

The factors affecting the rate of reactions include the following;

1. The concentration of an enzyme

Provided that the substrate concentration is maintained at a high level and other conditions such as pH and temperature are maintained constant, the rate of a reaction increases with increase in enzyme concentration until when the rate remains constant. Usually the enzyme concentration is much lower than the substrate concentration. Therefore as the enzyme concentration increases, the rate of substrate is either being exhausted in the reaction or greatly reduced thereby limiting the reaction.

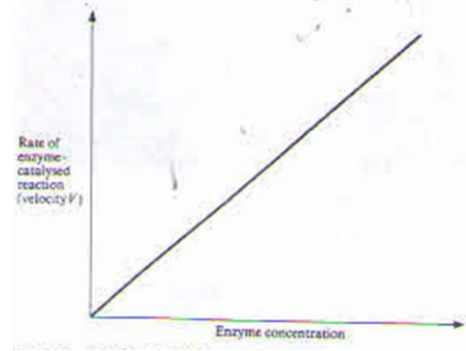

2. Substrate concentration

The rate of enzyme controlled reaction increases with increase in the substrate concentration for a given quantity of an enzyme until such a concentration when all the active sites of an enzyme are saturated. At such concentration the rate of reaction becomes constant or levels. After leveling of the rate of the reaction, the rate can only be increased by increasing enzyme concentration which would provide new active sites for the substrate. The increase in substrate concentration increases the interaction between the enzyme molecules and the substrate molecules which increases the rate of collision between the enzyme and the substrate so as to form the products.

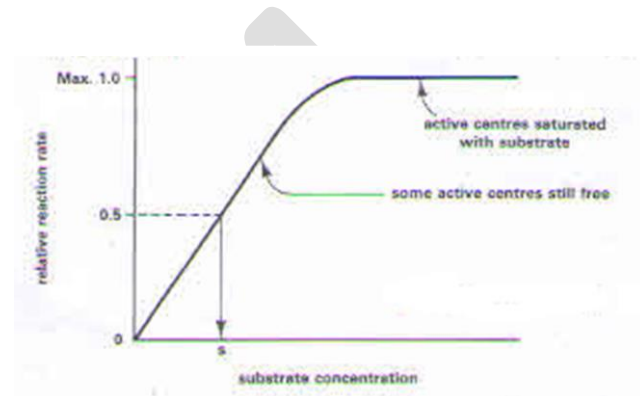

3. Temperature

An increase in temperature affects the rate of an enzyme controlled reaction in two ways;

- As the temperature increases the kinetic energy of the substrate and enzyme molecules also increases and so they move fast. The faster these molecules move, the more they collide with one another and therefore the greater the rate of reaction.
- Secondly as temperature increases more atoms which make up the enzyme molecules vibrate. These vibrations break the hydrogen bonds and other forces which hold the molecules in their precise shape hence changing enzyme active sites. The three dimensional shape of the enzyme molecules is therefore changed by these vibrations as the bonds, hydrogen bonds and hydrophobic interactions, which were holding it get broken to such an extent that the active site no longer allows the substrate to fit. Under these conditions the enzyme is said to be **denatured** by the increasing temperature and therefore loses its catalytic properties. Therefore increasing the temperature beyond the optimum temperature rapidly denatures enzymes and very low temperatures **inactivate** enzymes. At the optimum temperature enzymes attain their maximum activity thereby providing the maximum rate of the reaction. Inactivated enzymes are not denatured and therefore they can regain their catalytic properties when higher temperatures are provided.

Note. The optimum temperature for an enzyme varies considerably. Many arctic and alpine plants have enzymes which function at a temperature 10°C , whereas those in algae inhabiting some hot springs continue to function at temperatures around 80°C . For many enzymes, the optimum temperature lies around 40°C and denaturation occurs at about 60°C .

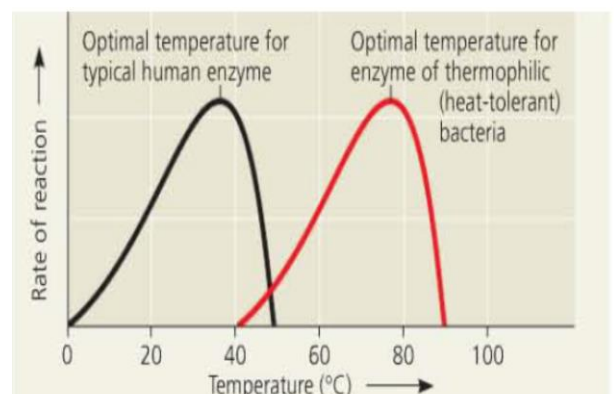
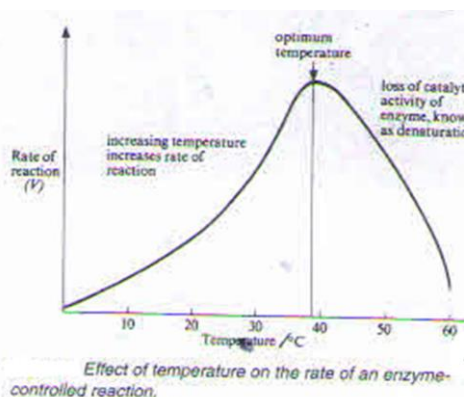

4. PH

The hydrogen bonds which make up the three dimensional molecular shape of the enzyme may be broken by the concentration of hydrogen ions present. PH is the measure of the hydrogen ion concentration. By breaking the hydrogen bonds which give enzyme molecules their shape, any change in the pH can effectively denature enzymes. Each enzyme works best at a particular pH and deviations from this optimum pH may result into denaturing of these enzymes.

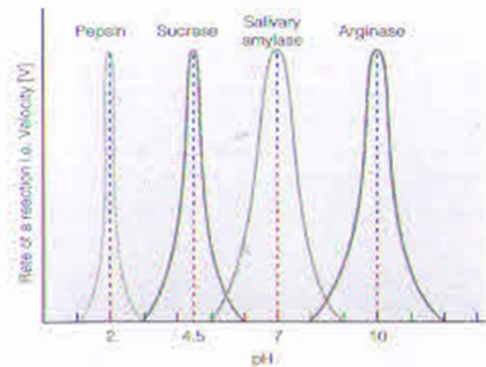

The rate of enzyme controlled reaction may be decreased by the presence of inhibitors. There are two types of inhibition namely;

- I. Competitive inhibition.
- II. Non-competitive inhibition.

Competitive inhibition

This is where inhibitors are structurally similar to the substrate molecules and as a result compete with the substrate for the active site on the enzyme molecule.

The degree of inhibition depends on the relative concentration of a substrate and inhibitor. This inhibition is therefore always reversible i.e. the inhibition effect can be removed by increasing the concentration of the substrate. This inhibition occurs when the inhibitor is of a higher concentration than the substrate. This inhibition is therefore temporary and therefore does not cause permanent change to the enzyme

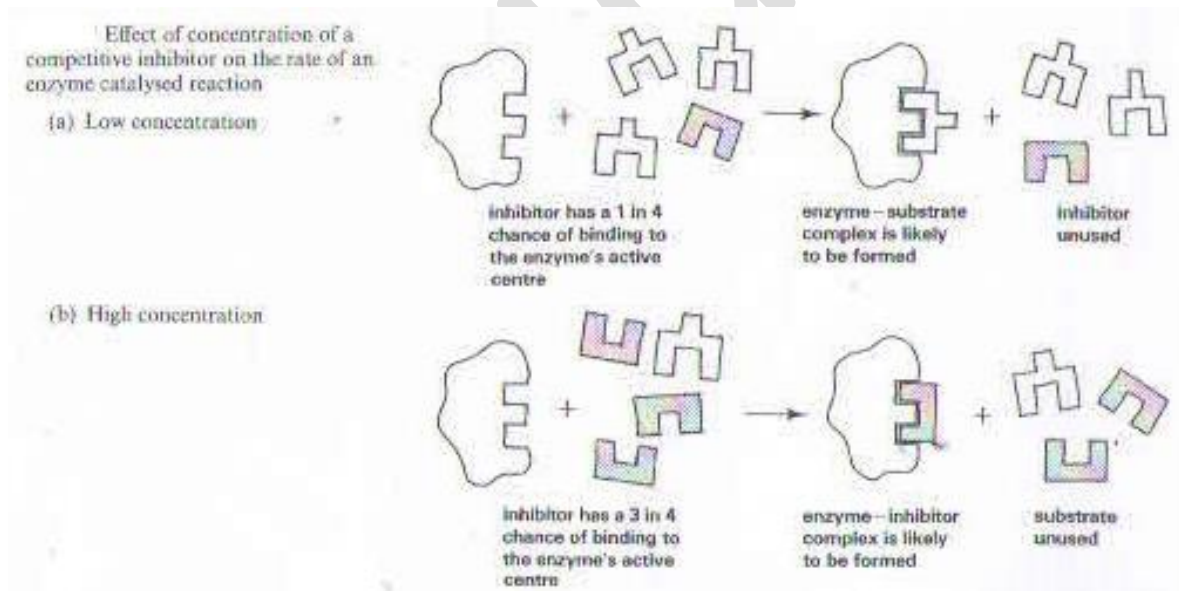

Once the inhibitor combines with the enzyme active site it prevents the substrate molecules from occupying the active site and so reduces the rate of the reaction. Melanic acid is an example of a competitive inhibitor.

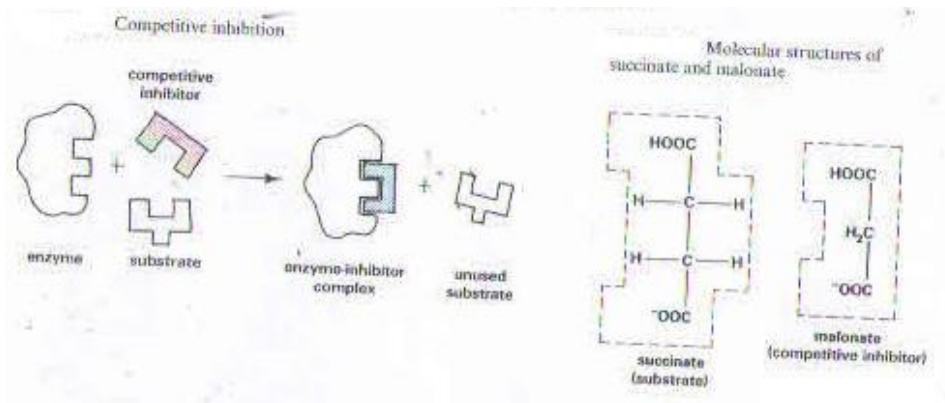

Non- competitive inhibition

This is where inhibitors are structurally different from the substrate and as a result do not compete with the substrate for active site on the enzyme molecules but its attachment elsewhere on the enzyme changes the structure of the active site so that the substrate cannot fit. These inhibitors show no structural resemblance to the substrate

These inhibitors attach themselves on the surface of the enzyme other than the active site thereby changing the shape of the active site which is at another location of the enzyme molecule. This change of the active site is achieved by an **allosteric** change and these inhibitors prevent the enzyme from carrying out its activities.

The degree of inhibition depends on the concentration of the inhibitor alone and cannot be varied by changing the amount of the substrate. This inhibition may be reversible to some extent or irreversible in most cases it is irreversible, this is because it depends mainly on the concentration of the inhibitor alone because the substrate does not compete with the inhibitor. In this inhibition the enzyme active site is changed in such a way that it can no longer accommodate the substrate.

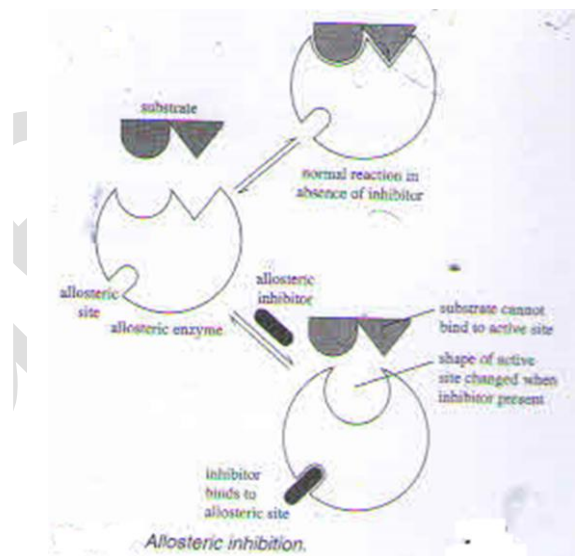

Irreversible non-competitive inhibitors leave the enzymes permanently damaged and so unable to carry out its catalytic function. Example of inhibitors include potassium cyanide which attaches its self to the copper prosthetic groups of an enzyme called cytochrome oxidase thereby inhibiting respiration hence causing death. Others include heavy metal ions such as mercury ions Hg, Pb and Ag which cause disulphide bonds in proteins to break whereby denaturing all the proteins. Disulphide bonds maintain the shape of the enzyme molecule and once broken the structure of the enzyme molecules becomes irreversibly altered with a permanent loss of its catalytic property

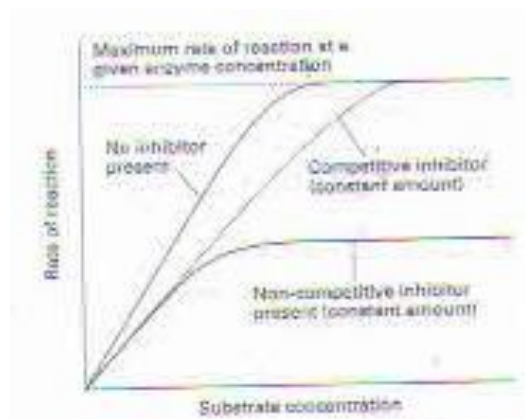

Importances of enzyme inhibitors

- i. They provide important information about the shapes and properties of the active site of an enzyme.
- ii. They can be used to block particular reactions thereby enabling bio-chemists to re-construct metabolic pathways
- iii. They can be used in medicine and agriculture e.g. as drugs and pesticides respectively.
- iv. Enzyme inhibition is also used to control the metabolic pathways by regulating the steps in them. This usually occurs during end product inhibition.

NOTE: allosteric enzymes are the ones which can change the shape of the active site due to the presence of a non-competitive inhibitor at a second site where the inhibitor binds known as **allosteric sites**.

An allosteric effect is the one where a chemical reaction involving one region of a protein molecule changes the shape and property of the second region of the protein molecule known as an active site.

ENZYME CO-FACTORS

A co-factor is a non-protein substance which is essential for some enzymes to function efficiently. There are three types of co-factors i.e. activators, co-enzymes and prosthetic groups.

Activators

These are inorganic substances, usually metal ions, which are necessary for the functioning of certain enzymes. The enzyme thrombokinase which converts prothrombin protein in blood plasma to thrombin during clotting is activated by calcium ions (Ca^{2+}).

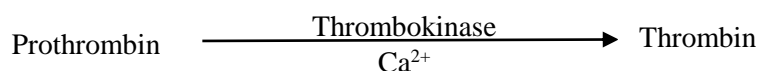

Co-enzymes

These are non-protein organic substances which are essential for the efficient functioning of some enzymes but are not themselves bound to the enzyme i.e. acetyl co-enzyme A.

Prosthetic group

This is a non-protein organic or inorganic substance which is essential for the efficient functioning of some enzymes and it bound to the enzyme.

Control of enzyme activities

- Secretion in inactive form like pepsinogen which is only activated at the site of action
- Precursor activation where accumulation of a potential substrate causes particular reaction pathways to be opened up
- Enzymes are contained in membranes like lysosome being released only when there is work to be done
- Dynamic regulation like negative feedback where the end-products inhibit the initial reactions
- Through genetic control where the information stored in the nucleus is used to determine which enzymes are synthesised which in turn determines the limits of cell metabolism

INDUSTRIAL APPLICATIONS OF ENZYMES

- They are used in making biological detergents which are usually made using proteases produced in an extra-cellular form from bacteria
- They are used in baking industry in which fungal α -amylase enzymes which catalyses the breakdown of starch in the flour to be used.
- They are used in making baby foods which contain trypsin used to pre-digest the baby foods.
- They are used in the brewing industry which uses enzymes produced from cereals during beer production to produce simple sugars from starch which is used by the yeasts during fermentation to enhance alcohol production.
- They are used in the dairy industry where an enzyme rennin derived from the stomach of young ruminant animals is used to manufacture cheese. In addition lactose breaks down lactose glucose and galactose.
- The rubber industry uses catalase enzyme to generate oxygen from peroxides so as to convert latex to form rubber.
- They are used in the paper industry which uses amylase to degrade starch to a lower viscosity product needed for sizing and coating paper.
- They are used in the photographic industry which uses protease to dissolve gelatin away from the scrop films thereby allowing the recovery of the silver present.

REVISION QUESTIONS

- Fat and glycogen are energy storage compounds in animals.
 - State the properties of both compounds as energy storage compounds. (4 marks)
 - State the advantages of storing fat over glycogen. (3 marks)
 - Why is glycogen a more suitable energy compound than fat? (3 marks)
- (a) Using the structural formula below and $\text{CH}_3(\text{CH}_2)_n\text{COOH}$, show how a triglyceride is formed. (03 marks)

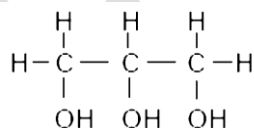

- What properties do lipids possess as storage food substances? (03 marks)
- Give the adaptations of the following to their functions
 - Cellulose (02 marks)
 - Starch (02 marks)

- The diagram represents a **phospholipid molecule**.

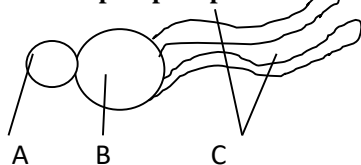

- Name the parts of the molecule A, B and C (03 marks)

- ii) Explain how the phospholipid molecules form a double layer in a cell membrane. (06 marks)
- b) Give two functions of the protein molecules in the cell membranes. (02 marks)
- 4. (a) Giving an example in each case; explain what is meant by;
 - (i) Aldose sugar. (1½ marks)
 - (ii) Ketose sugar. (1½ marks)
- (b) Explain how the storage property of starch is related to its molecular structure. (04 marks)
- (c) Although chitin and cellulose are both tough structural polysaccharides, chitin is a more suitable component of insects' exoskeleton than cellulose. Explain this statement. (03 marks)
- 5. a) describe how polypeptide chains may be arranged to form protein molecules 4marks
- b) Explain how inhibitors can alter the rate of reaction acting indirectly 3mar
- c) Suggest why amylase breaks down starch but it does not break down cellulose 3marks
- 6. Figure 7 below shows the effect of varying substrate concentration on an enzyme catalysed reaction, in absence and presence of compound A.

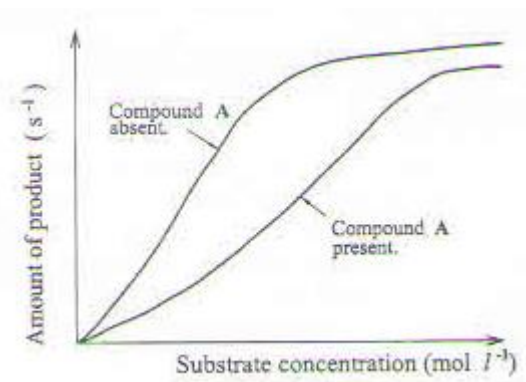

- (a) Explain the relationship between rate and substrate concentration
 - (i) in absence of compound A (03 marks)
 - (ii) in presence of compound A (04 marks)
- (b) state two factors which would have to be kept constant in this experiment (01)
- (c) What would be the effect of increasing the concentration of compound A in the experiment? (02 marks)

7. Figure 7 shows the effect of substrate concentration on enzyme activity

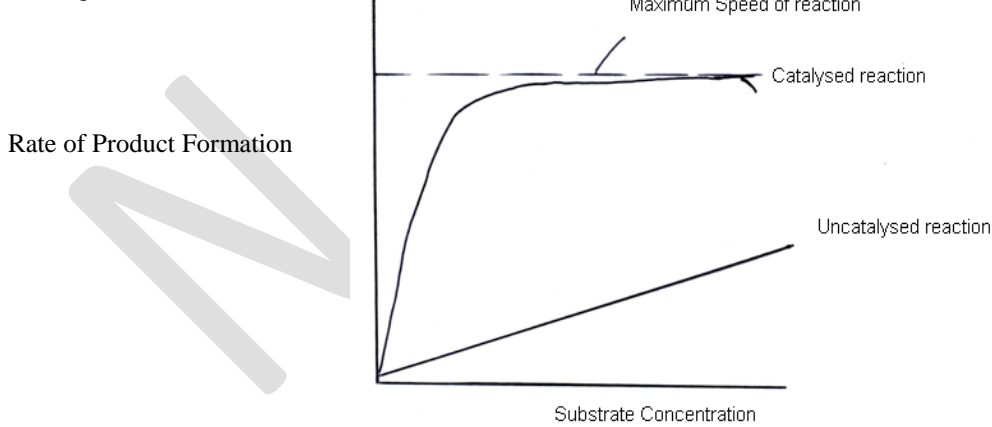

- a) Compare the differences in the rate of reaction in catalyzed and uncatalysed reactions (05 marks)
- b) Explain why the enzyme catalyzed reaction finally levels off (02 marks)
- c) Describe any **three** substances that help enzymes to perform their catalytic activity (03 marks)

8. Figure 3 shows the activity of bacterial enzymes at different PH and temperature

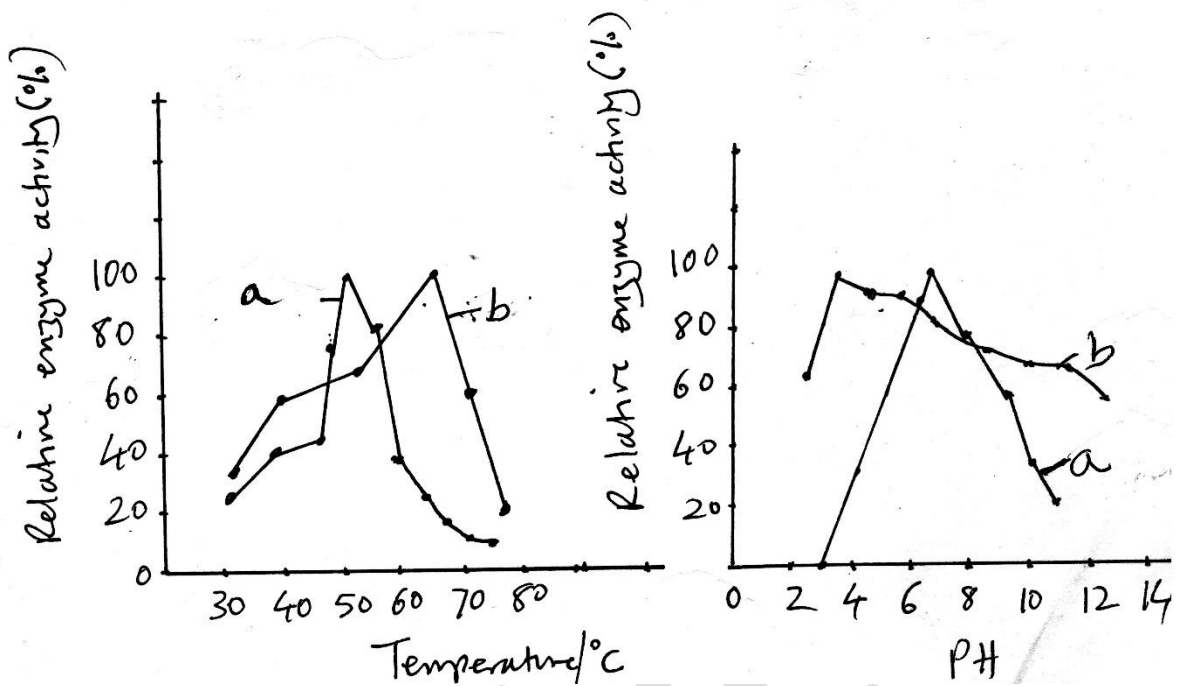

- (a) Which graph represents the bacteria that live in
 - (i) cool and neutral conditions..... (1/2 mark)
 - (ii) hot and acidic conditions..... (1/2 mark)
- (b) Compare the changes in enzyme activity with temperature and PH for organisms that live in hot and acidic environment to those that live in cool and neutral environment(04 marks)
- (c) With reference to enzyme structure explain how the following factors affect enzyme activity
 - (i) PH (02 marks)
 - (ii) temperature(01 mark)
- (d) Explain why the same enzyme may be able to work at different optimum PH and temperature conditions in similar organisms living in different environments (02 marks)

9. Figure 3 is a graph that shows the comparative effects of non-competitive and competitive inhibitor on the rate of an enzyme-catalysed reaction

Figure 3

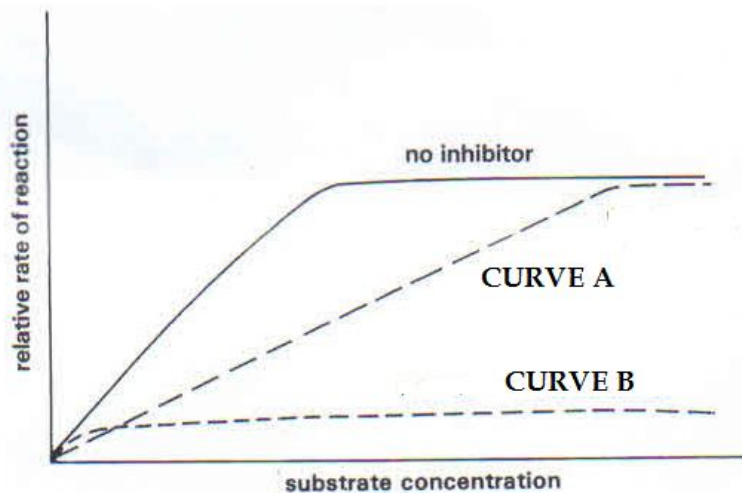

- a) Identify the curve that shows the effect of (02 marks)
- A competitive inhibitor
 - A non-competitive inhibitor
- b) Explain the changes in relative rate of reaction in;
- Curve A (03 marks)
 - Curve B (03 marks)
- c) State any **two** applications of enzyme inhibitors (02 marks)

10. (a) Clearly distinguish between the following

- The primary structure and the secondary structure of proteins. (02marks)
 - Co-enzyme and a prosthetic group. (02marks)
- (b) How is the structure of a protein used in regulation of blood pH? (03marks)
- (c) Explain how excess proteins lead to kidney stones. (03marks)

11. Locusts are insects that are capable of flying for relatively long periods of time. When flying, locusts use carbohydrates and lipids as energy sources. An experiment was carried out to investigate changes in the concentration of monosaccharides and lipids in the blood of a locust during flight. Measurements were made of the concentrations of monosaccharide and lipid at the beginning of the flight and at 60 minutes intervals during the flight. The results are shown in table 4 below.

Time during flight in minutes.	Concentration in gmm^{-3} of	
	monosaccharide	Lipid
0	30	3.0
60	13	10.0
120	12	19.0
180	11.5	20.0
240	11.0	20.0
300	11.0	20.0

- (a) Compare the changes in the concentration of monosaccharide with the changes in the concentration of lipid during flight. (04 marks)
- (b) Suggest an explanation for the changes in the concentrations of both of these compounds during flight (05 marks)
- (c) In this investigation, the mass of stored glycogen in the locust was also measured and was found to decrease by 390 during flight. Suggest an explanation for this change in the mass of glycogen. [01 mark]

12. a) Describe the induced fit hypothesis of enzyme action. (08 marks)
- b) Explain how the following affect enzyme activity
- temperature (06 marks)
 - competitive inhibition (06 marks)
13. (a) Explain how temperature affects enzyme activity in a metabolic reaction. (12 marks)
- (b) Describe the induced fit hypothesis of enzyme action. (08 marks)
14. (a) What are the ways in which lipids differ from carbohydrates? (05 marks)
- (b) With examples describe the functions of lipids in organisms. (10 marks)
- (c) Why do animals store lipids instead of carbohydrates? (05 marks)
15. (a) Compare the suitability of lipids and carbohydrates as storage compounds in organisms. (06 marks)
- (b) With examples, describe the functions of lipids in organisms. (14 marks)
16. (a) Distinguish between the lock and key and induced fit hypothesis of enzyme action. (05 mark)
- (b) Explain how temperature affects the activity of an enzyme. (10 marks)
- (c) How are enzymes activities controlled? (05 marks)
17. A group of students carried out an experiment to compare the properties of two enzymes. Catalase and carbonic anhydrase. The concentrations of the substrate and enzyme were the same at the beginning of the experiment and temperature was maintained at 37°C. Catalase hydrolysed substrate A while carbonic anhydrase hydrolysed

substance B. The students determined the mass of substrates A and B every 10 minutes intervals to establish the rate of reactions A and B. The results are shown in the table below.

Time in minutes	Mass of substrate in g		Rate of reaction	
	A	B	A(g min ⁻¹)	B(gmin ⁻¹)
0	200	200	0	
10	192	182	19.2	
20	184	176	18.4	
30	170	165	17.0	
40	162	150	16.2	
50	104	98	10.4	
60	80	30	8.0	
70	30	10	3.0	
80	10	5	1.0	

- a) Copy and complete the table by calculating the rate of enzyme controlled reaction B at every 10 minutes intervals (04 marks)
- b) Plot a suitable graph to compare the rate of enzyme controlled reactions A and B. (10 marks)
- c) Which of the enzymes has a higher turnover number? Give reasons for your answer. (02 marks)
- d) (i) suggest the names of the substances used in reactions a and B. (02 marks)
(ii) Explain the changes in the rates of reactions A and B shown by your graph. Illustrate your explanation with equations. (05 marks)
- e) Explain what would happen
- (i) If mercury was added to reaction B (08 marks)
- (ii) Malonic acid was added to reaction A (08 marks)
- f) Why was temperature kept constant? (01 mark)
18. (a). Describe the structure of the protein molecule. [7mks]
(b). Compare the structure of proteins to those of carbohydrates [9mks]
(c). What structural features of carbohydrates account for the wide Variety of polysaccharides? [4mks]
19. a) Give an account of the chemical nature and variety of carbohydrates (10 marks)
b) Outline the role of carbohydrates in the life of a plant. (10 marks)
20. a) What is meant by the term protein? (03 mark)
b) Discuss with suitable examples the variety of functions of proteins. (12 marks)
c) Explain how their structure permits this wide variety of functions. (6 marks)
21. a) Describe the structure of the following. (10mks)
i) Starch
ii) Cellulose
- b) Show how a triglyceride is formed. (4mks)
c) Outline the importance of triglycerides in living organisms. (11mks)
22. a) Why is calcium ion important in the human body? (5mks)
b) Water is essential for life. Explain in what ways this statement is true for plants and animals. (15 mks)

An experiment was carried out to investigate the effect of alcohol on the activity of pancreatic amylase. Dilutions of ethanol in water were prepared in order to give a range of percentage concentrations from 0% to 70%.

To each of the 8 test tubes was added 1cm³ of the appropriate concentration of ethanol, followed by 2cm³ of a 1% starch solution. 2% of pancreatic extract were added to each test tube and the time, in seconds, required for starch hydrolysis was recorded. The table below shows the results:

Test tube	% concentration of ethanol added to each test tube.	Time required for complete starch hydrolysis/seconds.
1	0	100
2	10	80
3	20	90
4	30	100
5	40	130

6	50	190
7	60	240
8	70	300

- a) Calculate the initial mass, in mg, of starch per test tube.
- b) Calculate the ;
 - i) % of ethanol in the reaction mixture for each test tube.
 - ii) rate of starch hydrolysis in each test tube, in milligrams per minute.
- c) Draw a graph to show the relationship between ethanol concentration and the rate of starch hydrolysis.
- d) Give reasons for the change in the rate of starch hydrolysis with increasing ethanol concentration
- e) Organic solvents like ethanol are known to alter the three dimensional structure of globular proteins. Explain, in terms of enzyme structure and function, the effect of concentrations of ethanol greater than 6% in the reaction mixture.

23. The browning which occurs when many types of vegetables and fruits are peeled is caused by enzymes called *phenol oxidases*. These catalyse the relatively slow conversion of naturally phenolic compounds into dark brown melanins.



The results in the table below were obtained from investigation into the browning of cubes of apples. Study the information and use it to answer the questions that follow

Cube number	Contents of cube (cm ³)					Appearance of cube contents after 10 minutes at room temperature
	Catechol	Apple extract	Buffer (pH = 7)	Dilute acid	Dilute base	
1	2	-	5	-	-	Colour less
2	-	2	5	-	-	Light brown
3	2	2	3	-	-	Dark brown
4	2	2	-	3	-	Colour less
5	2	2	-	-	3	Light brown
6	2	2 (boiled)	3	-	-	Colour less

- a. From the information given in the table, what type of substance do you think catechol is, and what purpose it serves in this investigation? (2 marks)
 - b. Use the results above to;
 - i) Suggest two ways in which apples, once peeled, can be prevented from turning brown? (2 marks)
 - ii) State what the apple extract contains? (2 marks)
 - c. Explain your answer in b (i) above (10 marks)
24. The rate of hydrolysis of starch by amylase enzyme was used to investigate the effect of a competitive inhibitor on enzyme action. A fixed amount of the enzyme and inhibitor was used at varying concentrations of the substrate. The data in the table below was obtained from the investigation. Use it to answer the questions that follow.

Substrate concentration (mol)		0.0	0.1	0.25	0.5	0.75	1.0	1.25	1.50
Rate of reaction (arbitrary units)	No inhibitor present	0.0	0.20	0.40	0.63	0.78	0.93	0.93	0.93
	Inhibitor present	0.0	0.15	0.30	0.45	0.60	0.73	0.80	0.92

- (a) Represent the data on a suitable graph. (10 marks)
- (b) Explain the shape of the graph obtained when,
 - (i) Only the enzyme was used? (4 marks)
 - (ii) The inhibitor was present? (4 marks)

- (c) (i) Indicate on your graph, the results that could have been obtained if a non-competitive inhibitor was used instead of a competitive inhibitor? (2 marks)
- (ii) Explain your answer in c (i) above? (5 marks)
- (d) Use the lock and key hypothesis to explain the mode of action of amylase enzyme (8 marks)
- (e) Explain how gastric juice affects the action of amylase enzyme? (7 marks)
25. Give an account of the diversity of polysaccharides? (20 marks)
26. (a) Give an account of the structure of starch, and explain how structure is related to functioning? (b) Explain why:
 (i) animal cells store glycogen and not starch as an energy source.
 (ii) many organisms store fats rather than carbohydrates in their bodies
27. (a) Compare the suitability of lipids and carbohydrates as storage compounds in organisms. (06 marks)
 (b) With examples, describe the functions of lipids in organisms (14 marks)
28. Briefly describe how starch and cellulose molecules form from their monomer subunits. (10 marks)
 b) Explain the role of carbohydrate molecules in plant life. (10 marks)
29. a) Outline the functions of carbohydrates in animals (05 marks)
 b) Starch is the major storage form of carbohydrates in plants. Describe;
 i) the structure of starch and
 ii) how the structure is related to function (15 marks)
30. a) Describe how starch and cellulose are formed from their monomer units (10 marks)
 b) Explain the importance of carbohydrates in plants (5 marks)
 c) Explain why certain organisms store lipids as the main storage form of energy instead of starch. (5 marks)
31. a) Distinguish between enzymes and inorganic catalysts. (05 marks)
 b) Give an account of how substrate concentration, pH and temperature can affect rate of enzyme catalyzed reactions. (15 marks)
32. (a). Describe the biological function of amino acids. (05marks)
 (b). Describe how amino acids form a polypeptide. (09marks)
 (c). How do inhibitors change the rate of enzyme controlled reactions? (06marks)
33. Describe the various characteristics of the carbon atom that makes possible the building of a variety of biological molecules. (06 marks)
 (b) What structural features of carbohydrates account for the wide variety of polysaccharides? (07 marks)
 (c) How is cellulose different from glycogen? (07 marks)

REFERENCES

1. D.T.Taylor, N.P.O. Green, G.W. Stout and **R. Soper**. Biological Science, 3rd edition, Cambridge University Press
2. M.B.V.**Roberts**, Biology a Functional approach, 4th edition, Nelson
3. C.J.Clegg with D.G.Mackean, ADVANCED BIOLOGY PRICIPLES AND APPLICATIONS, 2nd EDITION, HODDER EDUCATION
4. Glenn and Susan **Toole**, NEW UNDERSTANDING BIOLOGY for advanced level, 2nd edition, Nelson thornes
5. Michael **Kent**, Advanced BIOLOGY, OXFORD UNIVERSITY PRESS
6. Michael Roberts, Michael Reiss and Grace **Monger**, ADVANCED BIOLOGY
7. J.SIMPKINS & J.I.WILLIAMS. ADVANCED BIOLOGY

TOPIC 3: INHERITANCE

SYLLABUS EXTRACT

Content & Subtopic	Specific objectives : The learner should be able to:
<p>Chromosomes</p> <ul style="list-style-type: none"> Composition of the chromosomes and structure of nucleotides. Structure of the nucleic acids the DNA and RNA differences between the DNA and RNA The Watson- Crick hypothesis and DNA. The DNA replication. Nature of genes. Structure of genetic code. 	<ul style="list-style-type: none"> Describe the composition of chromosomes and structure of nucleotides. Describe the structure of the DNA and RNA. Differentiate the DNA and RNA Explain the Watson Crick hypothesis of the nature of DNA. Explain the process of DNA replication. Describe the nature of genes. Describe the structure of the genetic code.
<p>Cell division</p> <ul style="list-style-type: none"> Mitosis and Meiosis Comparison of mitosis and meiosis. Role of mitosis and meiosis in living organisms Significance of the cell division events e.g. formation of the spindle fibres, chiasmata, synapsis, bivalents, and movement of chromosomes, e.t.c. 	<ul style="list-style-type: none"> Describe the mitosis and meiosis. Compare mitosis and meiosis State the significance of mitosis and meiosis to living organisms. Explain the significance of changes in the nucleus during cell division
<p>Protein synthesis</p> <ul style="list-style-type: none"> Formation of RNA (tRNA, mRNA). Process of protein synthesis Role of DNA and RNA in protein synthesis 	<ul style="list-style-type: none"> Describe the formation of RNA (tRNA, mRNA). Describe the process of protein synthesis State the role of DNA and RNA in protein synthesis
<p>GENETICS</p> <ul style="list-style-type: none"> Concept of inheritance Definition of genetics term e.g. Inheritance, gene, allele, chromosome, DNA, trait e.t.c. Mendel's work on heredity Monohybrid inheritance and dihybrid inheritance. Mendel's laws of inheritance: Law of independent assortment and law of segregation. Challenges of heritage disorders, 	<ul style="list-style-type: none"> Explain the concept of inheritance. Define genetics terms Describe Mendel's investigations on heredity Explain the two Mendel's laws of inheritance Explain inheritance of traits using the monohybrid and dihybrid crosses. Discuss the challenges of disorders
<ul style="list-style-type: none"> Chromosomes and genes Terms <ul style="list-style-type: none"> Gene interactions definition and examples linkage, multiple alleles, codominance, incomplete dominance, dominant and recessive traits, epistasis, complementary gene. Sex linkage; definition, examples and inheritance Sex determination; definition example in humans Sex limitation definition and examples Lethal genes definition and examples: phenylketonuria neurospora e.t.c. Polygene definition and examples 	<ul style="list-style-type: none"> Explain the terms: gene interactions, sex linkage, sex determination, sex limitation, lethal genes and polygenes. Explain gene and chromosome mapping

<ul style="list-style-type: none"> • Gene and chromosome mapping. 	
<p>VARIATION</p> <ul style="list-style-type: none"> • Population traits and types of variations. Continuous (quantitative) and discontinuous (qualitative). • Causes of variation: genetic and environmental factors. <ul style="list-style-type: none"> - Definition of mutation. - Types of mutations gene and chromosomal mutation. - Causes of mutation: chance, radiation, chemicals. - Differences between the chromosomal and gene mutations. - Variation among organisms - Data on variations among organisms (e.g. sex, height, tongue rolling) 	<ul style="list-style-type: none"> • Explain population traits and types of variation. • Describe the causes of variation • Define mutation • Described types and causes of mutations • Distinguish between chromosomal and gene mutations. • Explain the significance of mutations • Identify variations in organisms. • Collect data on variations among themselves

NUCLEIC ACIDS

These are nitrogen containing organic acids important for making the genetic material and proteins of all organisms.

Nucleic acids are made of short chains called **nucleotides**, made up of CHONP. Nucleic acids include **Deoxyribose Nucleic Acid (DNA)** and **ribonucleic acid (RNA)**.

THE STRUCTURE OF NUCLEOTIDES

A nucleotide is made up of 3 components namely, pentose sugar, a nitrogenous base and a phosphate derived from phosphoric acid i.e. all nucleotides contain phosphoric acid.

A. PENTOSE SUGAR

The pentose sugars in nucleic acids are of 2 types namely; ribose sugar in RNA and deoxyribose sugar in DNA. The only difference between these two sugars is that deoxyribose lacks an oxygen atom on the second carbon atom in the ring; hence the name *deoxyribose*.

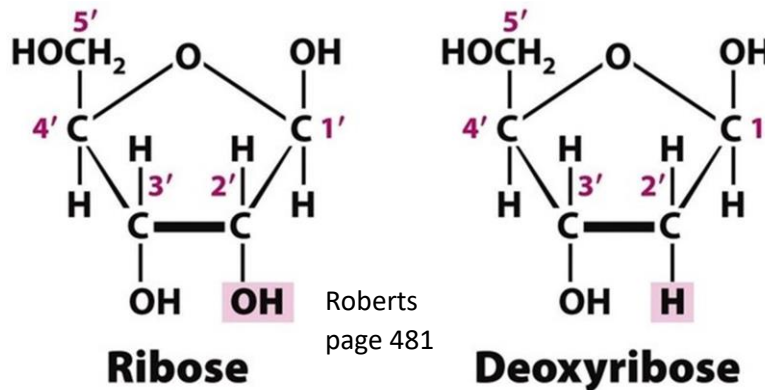

B. NITROGENOUS BASES

Each nucleic acid contains four different bases of which two are derived from **purines** and another two are derived from **pyrimidines**. The nitrogen in the rings gives the molecules their basic structure. These bases are;

Pyrimidines	Cytosine (C)	Thymine (T)	Uracil (U)	Purines have two rings in their structure while the pyrimidines have one ring in their structure i.e. purines are larger than pyrimidines. These bases are commonly represented by their initial letters A, G, C, T and U .
	DNA contains C and T while RNA contains C and U			
Purines	Adenine (A)	Guanine (G)		
	The purines A and G are found in both DNA and RNA			

Soper pg 108 fig 3.42 OR Roberts pg 486 fig 30.6

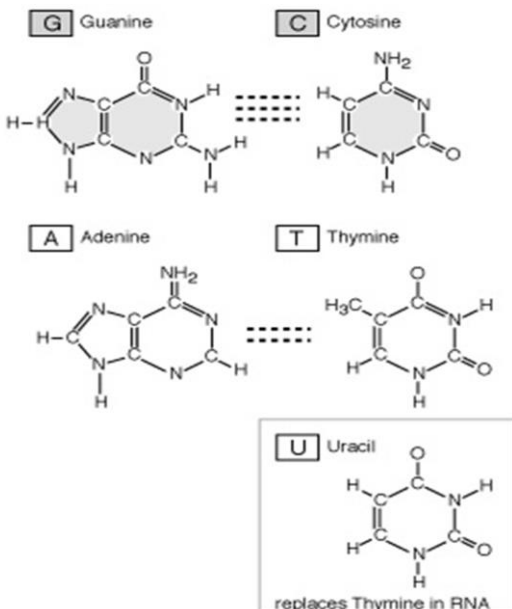

C. PHOSPHORIC ACID

This acid gives the acidic character to nucleic acids and its structure is shown below;

Roberts pg 482

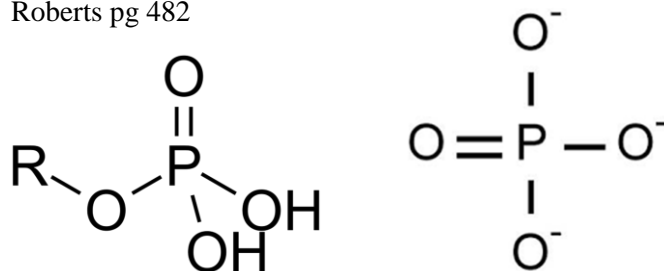

The three components of nucleotides are combined together by two **condensation reactions** to give a nucleotide whose structure is shown below

Fig 1 pg 36 Kent OR Fig 3.38 (diagrammatically) 106 Soper

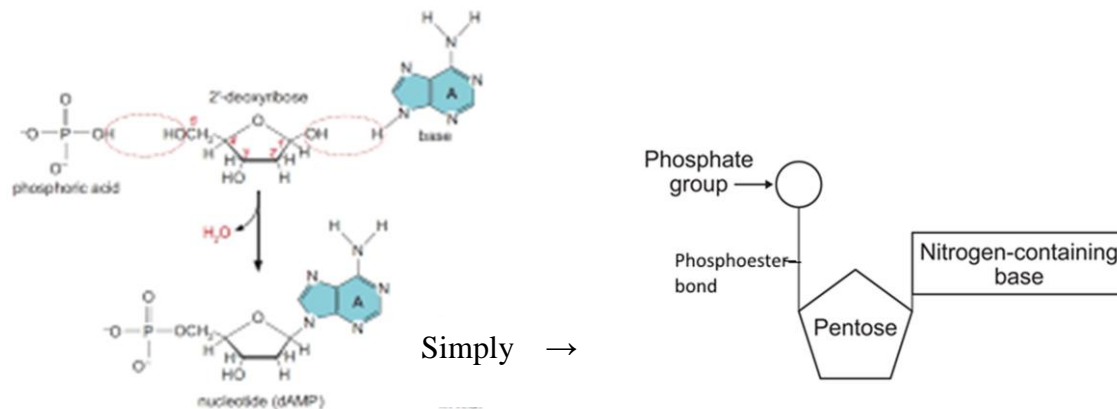

During this combination, the pentose sugar and organic base join together by a condensation reaction to form a **nucleoside**. Another condensation reaction joins the nucleoside to form the nucleotide joined together by a **phosphoester bond** located between carbon 5 of the sugar and the phosphate.

By similar condensation reactions between the sugar and a phosphate group of two nucleotides a **di-nucleotide** is formed linked together by phosphodiester bonds between carbon-3 of sugar and the OH group of the phosphate. Continued condensation reactions lead to formation of a **polynucleotide** as shown below;

Fig 30.1 B pg 482 Roberts

The main function of nucleotides is the formation of nucleic acids, RNA and DNA which play vital roles in **protein synthesis** and **heredity**. In addition, nucleotides form part of other metabolically important molecules; such molecules include Adenosine Tri Phosphate (**ATP**), Adenosine Mono Phosphate (**AMP**), Nicotinamide Adenine Dinucleotide (**NAD**), Flavine Adenine Dinucleotide (**FAD**), Nicotinamide Adenine Dinucleotide Phosphate (**NADP**) and co-enzyme A.

Note

Nucleotides polymerise by forming phosphodiester bonds between carbon 3' of the sugar and an oxygen atom of the phosphate. This is a condensation reaction. The bases do not take part in the polymerisation, so there is a **sugar-phosphate backbone** with the bases extending off it (projecting outwards). This means that the nucleotides can join together in any order along the chain. Two nucleotides form a dinucleotide, three form a trinucleotide, a few form an oligonucleotide, and many form a polynucleotide. A polynucleotide has a free phosphate group at one end, called the 5' end because the phosphate is attached to carbon 5' of the sugar, and a free OH group at the other end, called the 3' end because it's on carbon 3' of the sugar. The terms 3' and 5' are often used to denote the different ends of a DNA molecule.

RNA (ribonucleic acid)

RNA is a single stranded polymer of nucleotides where the pentose sugar is always ribose and the organic bases are adenine, cytosine, guanine and thiamine. There are many types of RNA found in cells, 3 of which are involved in protein synthesis. These include the following;

- a) Ribosomal RNA (rRNA) (80%)
- b) Transfer RNA (tRNA) (15%)
- c) Messenger RNA (mRNA) (3-5%)

RIBOSOMAL RNA (rRNA)

This is a large complex molecule made up of both double and single helices.

Although it is manufactured by the DNA of the nucleus it is mainly *found in cytoplasm* where it makes up more than half of the mass of the ribosomes. It comprises of more than a half of the mass of the total RNA of the cell and its sequence is similar in all organisms.

Ribosomes are the site of protein synthesis, at the ribosomes the mRNA code is translated into a sequence of amino acids in a growing polypeptide chain. This is possible because ribosomes are often found in clusters linked together by strands of mRNA. This cluster of ribosomes is known as *poly-ribosome* or *polysome* and this enables several molecules of the same polypeptide chain to be produced simultaneously.

RNA (ribonucleic acid)

RNA is a single stranded polymer of nucleotides where the pentose sugar is always ribose and the organic bases are adenine, cytosine, guanine and thiamine.

There are many types of RNA found in cells, 3 of which are involved in protein synthesis. These include the following;

RIBOSOMAL RNA (rRNA)

This is a large complex molecule made up of both double and single helices.

Although it is manufactured by the DNA of the nucleus it is mainly *found in cytoplasm* where it makes up more than half of the mass of the ribosomes. It comprises of more than a half of the mass of the total RNA of the cell and its sequence is similar in all organisms.

Ribosomes are the site of protein synthesis, at the ribosomes the mRNA code is translated into a sequence of amino acids in a growing polypeptide chain. This is possible because ribosomes are often found in clusters linked together by strands of mRNA. This cluster of ribosomes is known as *poly-ribosome* or *polysome* and this enables several molecules of the same polypeptide chain to be produced simultaneously.

TRANSFER RNA (tRNA)

This is a small molecule with about 80 nucleotides made up of a single strand. It comprises of 10 to 15% of the total RNA within the cell and all types of tRNA are fundamentally similar. There are at least 20 types of tRNA each one carrying a different amino acid.

It forms a clover leaf shape with one end of a chain ending in a **cytosine-cytosine-adenine(C-C-A)** base sequence. It is at this base sequence that an amino acid attaches itself.

At an intermediate point along the tRNA point is an important sequence of 3 bases called **anticodon**. These bases line up alongside the appropriate **codon** on the mRNA during protein synthesis.

This implies that each amino acid has its own tRNA molecule which transfers it from the cytoplasm to the ribosome to join the polypeptide chain being made.

The structure of t RNA is shown below;
Fig 30.11 pg 493 Roberts OR Fig 23.25 pg 801 Soper

Consequently tRNA acts as an intermediate molecule between the codon of mRNA and the amino acid sequence of the polypeptide chain on the ribosomes on the ribosomes. A codon is sequence of three organic bases which together form a unit of genetic code in a DNA or RNA molecule to specify an amino acid that joins a polypeptide

MESSENGER RNA (mRNA)

This is also a single stranded molecule containing triplets of bases known as codons. It is formed from a single strand of DNA during protein synthesis by a process known as *transcription*. During transcription, the DNA genetic information for protein synt

hesis is copied from the DNA strand to form codons of mRNA. Thereafter, mRNA attaches itself on a group of many ribosomes thereby forming a structure called **polysome** which is the site of protein synthesis.

(DEOXYRIBO NULCEIC ACID) DNA

This is a double stranded molecule containing repeated combination of many nucleotides which is transmitted from generation to generation in organisms. DNA is perhaps the most important molecule in biology. It contains the instructions that make every single living organisms. DNA is a polymer, composed of monomers called **nucleotides**.

Structure of DNA

According to **Watson and Click**, DNA consists of two strands each made up of very many nucleotides that repetitively combine to form very long polynucleotides. The strands are anti-parallel i.e. run in opposite directions. Each polynucleotide chain/strand forms a right handed helical spiral and consequently the two chains coil around each other to form a double helix.

The sugar-phosphate back bone is made of alternating deoxyribose sugar and phosphates. The two chains run in opposite directions. The double strands are held together by complementary base pairs between them. Each of these base pairs is in turn held by hydrogen bonds. During the **complementary base pairing**, Adenine must combine with Thymine while Guanine combines with Cytosine.

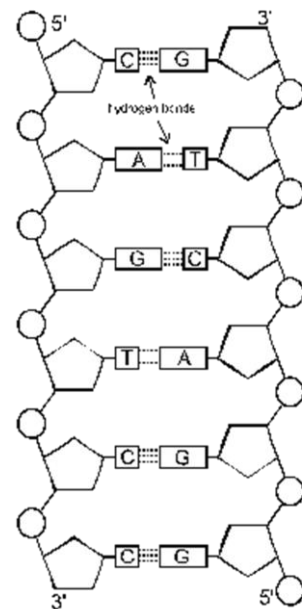

DNA showing the complementary base pairing between antiparallel strands



DNA showing the double helix

DNA is like a ladder where the alternating deoxyribose and phosphate units form the uprights and the organic base pairing to form the rungs. However, the strands are twisted instead of being like a ladder into a double helix so that each upright winds around the other. Such a **double helix structure** is shown on the right;

NOTE: the width between the two strands is constant and equal to the width of the base pair i.e. the width is equal to the purine plus the pyrimidine. Two purines would be too large and two pyrimidines would be too small to span the gap between the two chains of DNA. Therefore, adenine must combine with thymine while guanine must combine with cytosine.

The sequence of bases in one chain of DNA determines that in the other and consequently the two DNA chains are said to be complementary. Each of the polynucleotide chains in DNA is extremely long and may contain many million nucleotide units.

The amount of guanine is equal to the amount of cytosine in DNA and similarly, the amount of adenine is equal to that of thymine e.g. if a DNA molecule contains 40% of its bases as adenine and thymine, how many bases will be guanine in a DNA molecule?

$$A \text{ and } T = 40\%$$

$$G \text{ and } C = 100 - 40 = 60\%$$

Since the amount of C = the amount of G.

$$\text{Then the number of guanine bases} = \frac{60}{2} = 30\%$$

COMPARISON OF DNA AND RNA

RNA	DNA
It contains fewer nucleotides	It contains very many nucleotides i.e. it is longer than RNA
It is single stranded	It is double stranded
It may be a single or a double helix.	It is always a double helix
The pentose sugar is ribose	The pentose sugar is deoxyribose
It contains uracil	It contains thymine
The ratio of adenine to uracil and cytosine to guanine varies.	The ratio of adenine and thymine to cytosine guanine is constant
It is manufactured in the nucleus but found throughout the cell	It is found almost entirely in the nucleus
The amount varies from cell to cell and within the cell according to metabolic needs.	The amount is constant for all cells of the species except for the gametes where it is half
It exists in three basic forms; tRNA, mRNA and rRNA.	It exists in only one basic form but with an almost infinite variety within that form
It is chemically less stable.	It is chemically more stable.
It may be temporary for short periods	It is permanent.

Similarities Both:

- (1) are polymers of nucleotides
- (2) occur in the cytoplasm
- (3) carry genetic information
- (4) originate from the nucleus
- (4) have same purine bases adenine and guanine plus pyrimidine bases cytosine

The following is the evidence to show that DNA is a genetic material

- i. The chromosomes which play a role in cell division are made of DNA and histone proteins only. This implies that when a cell divides DNA is carried to the daughter cells formed.
- ii. DNA is constant in amount in all cells within the species except in gametes where it is a half.

- iii. It undergoes mutations which are inherited and without which it remains very stable so that the code instructions it contains remains unchanged from generation to generation.
- iv. DNA controls the activities of a cell by directing the synthesis of proteins. This is shown by the various transduction experiments in which the Bacteriophage (virus that attacks bacteria) transfers DNA to a bacterium called *Escherichia coli* (*E. Coli*). The virus DNA instructs *E. coli* to make many new bacteriophage viruses.
- v. The bases are protected on the inside of the molecule and the two strands are held together by numerous hydrogen bonds, so DNA a very stable molecule and is not easily damaged.
- vi. There are four different bases, which can appear in any order, so their sequence can encode information, like writing with a 4-letter alphabet.
- vii. DNA is a very long molecule, so it store a great deal of information (human DNA has 3 billion base-pairs).
- viii. The two complementary strands means there are two copies of the information, which is useful for repair, copying and error checking.

DNA REPLICATION

This is the process by which two DNA molecules make exact copies of its self.

This enables the transmission of the same genetic information from cell to cell and generation to generation. Replication is controlled by an enzyme **DNA polymerase** which links the DNA nucleotides to form long strands of DNA and **helicase enzyme** which causes the unwinding (opening up) of the DNA double strands into separate DNA strands by breaking hydrogen bonds between base pairs.

How DNA replication occurs

DNA starts when **Helicase** enzyme attaches on one of the DNA double helix strands and starts moving in the 5¹ to 3¹ direction along the strand. Helicase unzips the DNA double helix by catalyzing the breakdown of hydrogen bonds between the complementary base pairs of DNA.

DNA polymerase enzyme then binds to the unzipped DNA strand and also moves in the 5¹ to 3¹ direction following helicase. Many free nucleotides align alongside the DNA strand where DNA polymerase is attached. Each time DNA polymerase meets the next base on the strand; free nucleotides with the correct complementary bas is inserted into the new growing DNA strand. The free nucleotide is held in place by DNA polymerase until it binds to the preceding nucleotide on the new growing DNA strand, thus extending the new strand of DNA. For example, if

DNA polymerase meets thymine, a nucleotide carrying adenine is inherited into the new DNA strand. DNA polymerase continues to move in the 5¹ to 3¹ direction along one strand meeting one base at a time and instructing a complementary base to be added to the new DNA strand growing as this enzyme moves. This is called **continuous replication** because both DNA polymerase and helicase are moving in the same 5¹ to 3¹

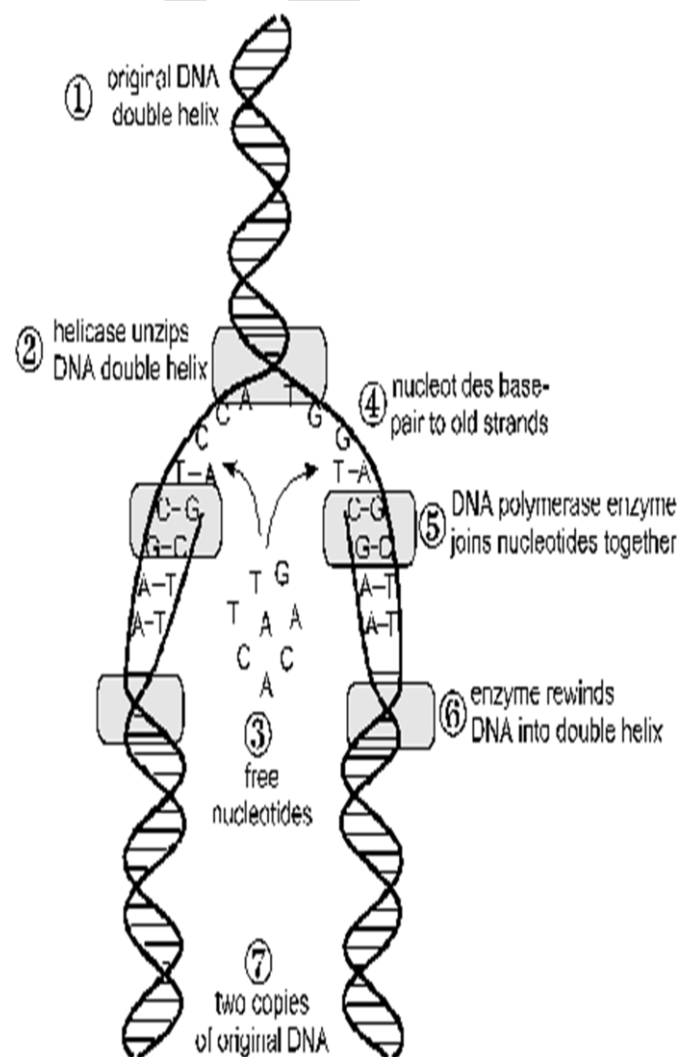

direction without leaving gaps in the new strand being synthesised. The strand formed is called the leading strand.

Discontinuous replication occurs when DNA polymerase attaches on another DNA strand and starts moving discontinuously in the 3' to 5' direction as helicase moves in the 5' to 3' direction. In this case, the copying of the parent DNA strand to form a new strand keeps on being started again because it has to move away from the unwinding enzyme in the 5' to 3' direction. This results in small gaps being left as many short segments of DNA are made. These gaps are closed by DNA ligase enzyme to form the second DNA strand, which joins the 5' end of DNA to the 3' end. The strand formed is referred to as the lagging strand.

The action of DNA ligase brings about three types of replication as it tries to complete the work of DNA replication. These types are;

1. Conservative
- (2) Semi-conservative
- (3) Dispersive

In **semi-conservative replication** the DNA strands unzip (separates) under the influence of helicase and then forms a new DNA strand for each of the old DNA strands using DNA polymerase. The new DNA molecule is composed of one old strand and one new strand.

In **conservative replication** the DNA strand unzips using helicase enzyme and forms two new DNA strands which zip together to become a DNA double helix made of new strands only. The old strands also zip together again after replication so that they form another new DNA molecule made of old strands only.

In **dispersive replication**, two new strands are formed each containing alternating old and new bases of nucleotides;

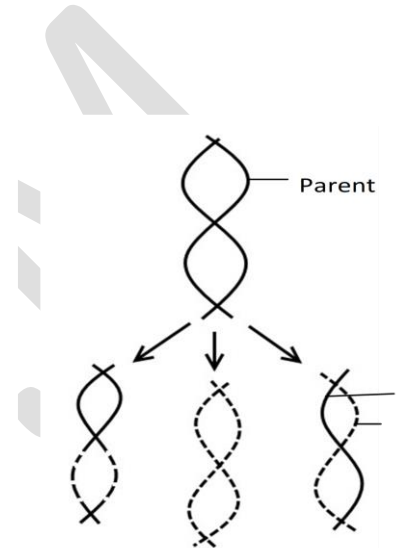

THE GENETIC CODE

The genetic code is the sequence of bases in DNA which codes for the sequence of amino acids in protein molecules. DNA provides the code (Genetic message) for the formation of proteins in an organism which may in turn determine the characteristics of that organism.

Every species possesses different DNA and therefore produces different enzymes. The DNA of the different species therefore differs not in the chemicals which it comprises but in the sequence of base pairs along its length. This sequence of triplet base pairs in DNA and mRNA is the code that determines which proteins are manufactured.

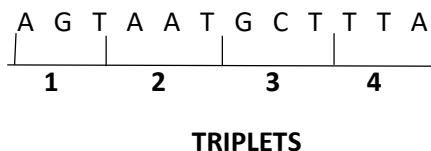

DETERMINING THE FIXING OF ONE AMINO ACID IN A POLYPEPTIDE

There are 20 amino acids which regularly occur in proteins and each of these must have its own code of bases on DNA i.e. the base pairs arrange themselves in form of triplets. This code is triplet because with only four different bases (A, G, C and T) present in the DNA, if each of them was coded for one amino acid, only four different amino acids could be coded for during protein synthesis which would be insufficient for protein formation. Using a pair of bases to specify an amino acid that should be picked by tRNA during protein synthesis gives 16 different codes that are possible for this picking. Therefore, a triplet code of bases has to be used to specify one amino acid that can be picked by tRNA during protein synthesis as this will produce 64 possible codes more than enough to specify the requirement of the 20 amino acids.

Table 23.4 pg 799 Soper OR Table 30.1 pg 498 Roberts

The genetic code is therefore a triplet code of word. Each word specifies the position of an amino acid in the corresponding protein chain. The triplet code constitutes the codons of mRNA as these codons are directly made from DNA. For example;

1. It is a triplet code
2. This triplet code is also called *a degenerate code* since there is more than one triplet for most amino acids i.e. it is a degenerate code because a given amino acid may be coded for by more than one code
3. It is punctuated i.e. it has a start codon usually AUG and three stop codons namely UAA, UAG and UGA.
4. The genetic code is also described as *universal* because the same triplets of bases code for the same amino acid in all organisms. In other words all codons are precisely the same for all organisms.
5. In addition, the genetic code is *non-overlapping* e.g. each triplet of bases is read separately UACACCAUGGGC is read as UAC-ACC-AUG-GGC.
6. The genetic code also leads to the formation of 3 codons namely, UAA, UAG and UGA which are called *nonsense codons*. These nonsense codons stop the process of protein synthesis by not coding for a specific amino acid at all.

THE CENTRAL DOGMA OF MOLECULAR BIOLOGY

It states that DNA makes RNA makes protein

PROTEIN SYNTHESIS

This is the process by which the coded information is transferred from the chromosomes in the nucleus to the ribosomes in the cytoplasm to make the proteins. There are three main stages in the formation of a protein namely;

1. Transcription
2. Amino acid activation
3. Translation

The process of protein synthesis is summarized in the diagram below;

Fig 23.26 pg 801 Soper

Fig 30.12 (1) pg 494 Roberts

TRANSCRIPTION

This is the mechanism by which the base sequence of a **cistron** of DNA strand is converted into the complementary base sequence of mRNA.

During transcription which occurs after replication of DNA, an enzyme **RNA polymerase** first recognises the **start sequence** in the DNA coding strand and becomes attached to the DNA at this point. This DNA coding strand has a specific region called cistron which is used for making mRNA. It is the cistron which is referred to as a **gene**.

The cistron comes into existence during replication when it unwinds. This unzipping is due to the breaking down of hydrogen bonds between the base pairs in the DNA double helix by **helicase enzyme**. The unzipping exposes the bases along the cistron. RNA polymerase then travels along the DNA cistron and new nucleotides complementary to those in the DNA strand are inserted into the growing mRNA strand. When this enzyme encounters thymine, adenine is inserted into mRNA and when it encounters cytosine, guanine is inserted into mRNA.

Therefore DNA acts as a **template** against which mRNA is constructed. A single molecule of DNA in each chromosome contains numerous shorter sections called genes (cistrons) each of which contains the instructions for making one protein. The coded instructions in each gene must specify the overall length of the protein chain and the exact position of the amino acids within the chain. At the end of transcription RNA polymerase recognizes the **stop sequence** on the cistron and becomes detached from the cistron at this point. Being too large to diffuse across the nuclear membrane, mRNA instead diffuses through the nuclear pores to the cytoplasm where it attaches itself on the ribosomes. In this way the instructions needed for protein synthesis is transferred into the

AMINO ACID ACTIVATION

Activation is the process by which amino acids combine with tRNA using energy from ATP under the influence of an enzyme **amino acyl tRNA synthetase**. This produces an amino acid tRNA complex with sufficient energy to form a bond with the neighbouring amino acid. The tRNA molecule with attached amino acid now moves to the ribosomes in order to form the polypeptide chain.

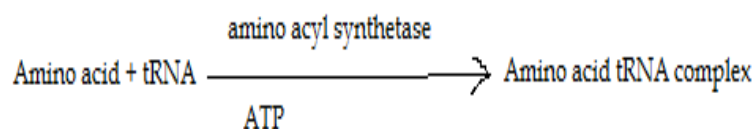

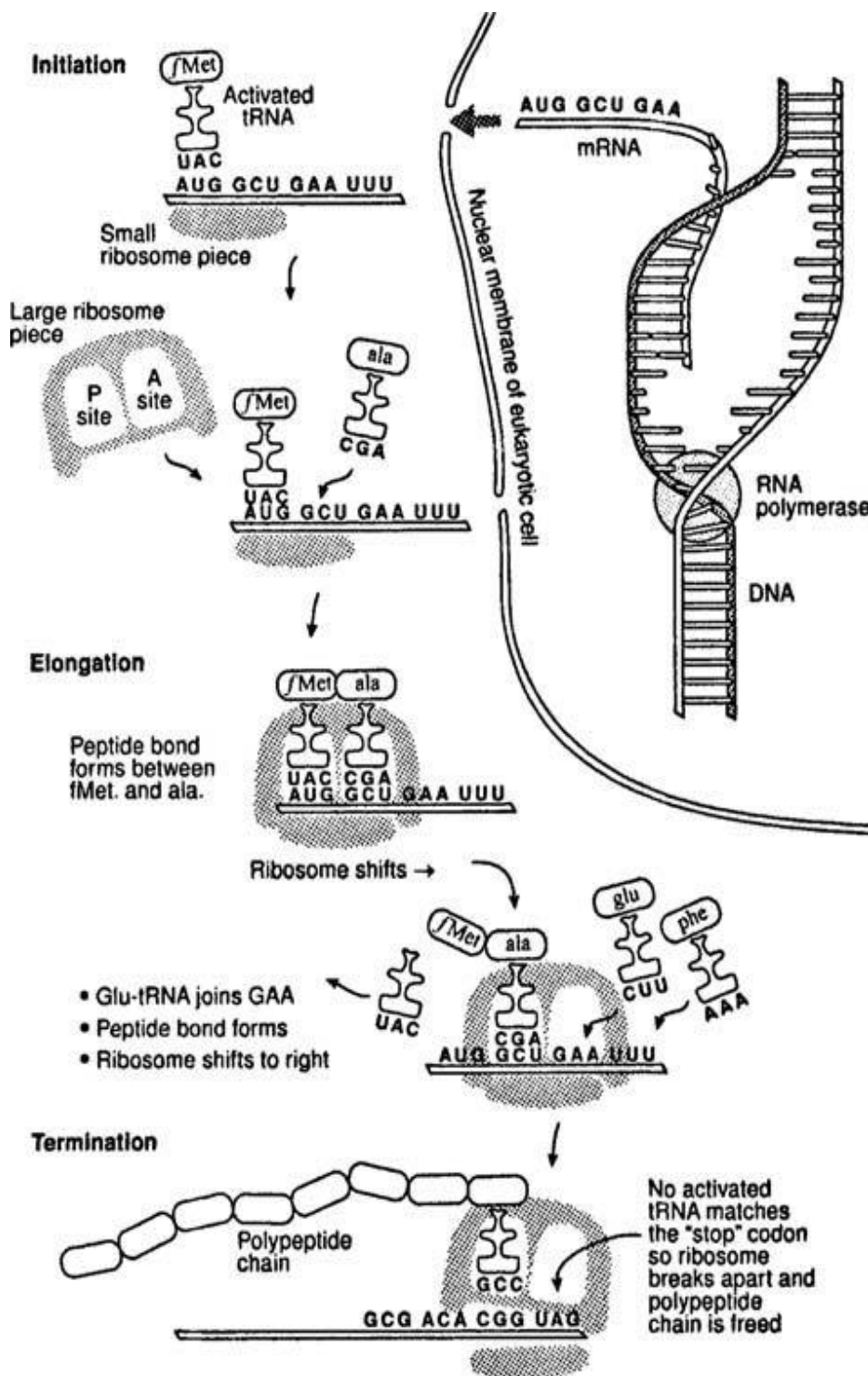

TRANSLATION

This is the mechanism by which the codons of mRNA are converted into a specific sequence of amino acids in a polypeptide chain on the ribosomes.

During this process mRNA attaches itself on a group of ribosomes (like beads on a string) to form a structure called *polysome*. Within the ribosomes there are two tRNA sites where the mRNA codon can become attached by complementary base pairing to a molecule of tRNA bearing the anti-codon.

Therefore the complementary anti-codon of the tRNA-amino acid complex is attracted to the first codon on the mRNA strand enclosed by the ribosomes. The second mRNA codon likewise attracts its complementary anti-codon of the second tRNA amino acid complex. The ribosome acts as a framework which holds the mRNA and the tRNA amino acid complexes together until the two amino acids form a *peptide bond* by a *condensation reaction* there by forming a *dipeptide*.

Once the two amino acids have combined into a dipeptide, the first tRNA is disconnected from its amino acid and therefore leaves the ribosome which moves one step along the mRNA strand so as to hold the next codon-anti codon complex together until the third amino acid is linked

Roberts pg 494 Fig 30.12 (2)

Roberts pg 494 Fig 30.12 (3)

with the second by a **condensation reaction**. In this way, a polypeptide chain is assembled by the addition of one amino acid at a time along the polysome (group of many ribosomes).

Roberts pg 494 Fig 30.12 (2)

Once each amino acid is linked to the growing polypeptide chain, the tRNA which carried it to the mRNA codon is released back into the cytoplasm. This tRNA is again free to combine with its specific amino acid in the cytoplasm. This sequence of the ribosome, steadily reading the mRNA code and translating it, continues until the ribosome comes into

The polypeptides formed in this way must now be assembled into proteins. Many polypeptides are made in this way because the second and subsequent ribosomes usually pass along the mRNA immediately behind the first ribosome, in this way many identical polypeptides are formed simultaneously.

The **main steps** involved in translation may be summarized as (1) binding of mRNA contact with one of the nonsense codes (terminating codes) UAA, UAG and UGA at which point the polypeptide is cast off or peeled off from the ribosome and dropped into the cytoplasm. to ribosome, (2) amino acid activation and attachment to tRNA, (3) polypeptide chain initiation, (4) chain elongation, (5) chain termination, (6) fate of mRNA

The genetic is of great importance during protein synthesis because;

1. The genetic code controls the formation of polypeptide chains in proteins by determining the length/number of codons of mRNA (by transcription) that carries this code to the ribosomes for polypeptide synthesis to proceed at the ribosomes hence indirectly determining the number of amino acids to be used in assembling a specific polypeptide
2. The genetic code determines the inheritance of characteristics from parents by determining the sequence of amino acids in a polypeptide chain since its triplet thereby determining the type of protein made
3. The genetic code directs the development of biochemical anatomical physiological and to some extent behavioural traits of an organism this is achieved through its control of protein synthesis by instructing the cell polypeptides to make
4. The genetic code has terminating codons (in mRNA) that stops the formation of a given polypeptide

NOTE:

1. The function of the ribosome in protein synthesis is to hold in position the mRNA, t RNA-amino acid complex and the asserted enzymes controlling the process until a peptide bond forms between adjacent amino acids.
2. DNA controls polypeptide chain synthesis
 - i. by instructing the cell which/what peptides to make.
 - ii. by forming mRNA by transcription, mRNA carries coded genetic information to the ribosomes for polypeptide synthesis to proceed at the ribosomes.

- iii. DNA's cistron length determines the number of codons mRNA should have hence indirectly determining the number of amino acids to be used in assembling a specific polypeptide
- iv. through DNA's triplet code system it determines the sequence of amino acids to be built in a polypeptide thereby determining the type of polypeptide
- v. during DNA's transcription to mRNA it forms nonsense codons that terminate the formation of a given polypeptide

CELL DIVISION

Cells undergo a series of changes in their life time during which they produce new daughter cells. Indeed, every cell is formed from an already existing cell by cell division i.e. where a cell exists, there must have been a pre-existing cells. The continuity of life is based on the reproduction of cells or cell division. When a unicellular organism such as amoeba divides and forms two offspring amoeba cells, the division of one cell reproduces an entire organism. There are two forms of cell division namely mitosis and meiosis. **Mitosis** promotes the multiplication of cells to bring about growth whereas **meiosis** promotes the multiplication of the species by promoting gamete formation in sexual reproduction.

Cell division occurs due to the presence of **chromosomes** in the nucleus of the cell. **Chromosomes** are thread like structures in the nucleus of the cell made of DNA molecules and histone protein. Structurally a chromosome contains a pair of elongated structures called **chromatids** which are joined together by the structure in the middle of the chromosomes called **centromere**.

Each chromatid contains many bead like structures made of DNA called **genes** which determine the characteristics of organisms. Chromosomes occur in pairs within the nucleus of the cell and the chromosome number varies from species to species e.g. in human beings there are 23 pairs of chromosomes in the nuclear cell i.e. 46 chromosomes. Therefore human beings are described as diploid organisms because they have diploid cells. A **diploid cell** ($2n$) is the one in which there 2 sets of chromosomes of which one set is inherited from the mother and another set from the mother. This implies that human beings have a chromosome number of 46 in their somatic cells or body cells and 23 chromosomes in their gamete cells. A **haploid cell** is one having only one set of chromosomes in the nucleus.

Before replication, each single chromosome contains at least one long linear DNA molecule that carries many genes which control the characteristics of an organism. The associated **histone protein** molecules maintain the structure of the chromosome and control the activity of genes.

NOTE;

- a. The sequence of events which occur between one cell division and the next is called the **cell cycle**.
- b. **Sister chromatids** are pairs of chromatids located on the same chromosome while non-sister chromatids are pairs of chromatids located on different chromosomes.
- c. **Homologous chromosomes** refer to structurally similar chromosomes one obtained from the mother and another from the father during fertilization which exists in the nucleus of a somatic cell of an organism.

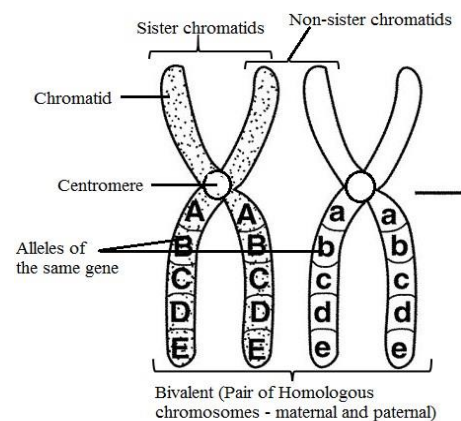

THE CELL CYCLE

This is the sequence of events which occur between one cell division and the next. It can also be defined as the life of the cell from the time it is first formed from a dividing parent cell until its own division into two or four cells.

A dividing cell duplicates its DNA and allocates the two copies of DNA to opposite ends of the cell and then splits into daughter cells, thereby making the daughter cells identical.

The cell cycle shows that the life cycle of the cell mainly involves **interphase** i.e. a period in which the cell prepares for the next cell division which is followed by nuclear division during mitosis and finally

cytokinesis during telophase of mitosis. Mitosis therefore involves both nuclear division and cytokinesis which alternates with a much longer stage called interphase. **INTERPHASE**
 A dividing cell spends about 90-95 % of time in interphase. Prior to cell division, either mitosis or meiosis, the mother cell undergoes a preparation stage known as interphase. During interphase the chromosomes are usually seen as tiny coiled threads known as chromatids and are therefore described as invisible chromosomes because details of the chromosome structure cannot be seen. During interphase four important changes take place in the cells.

- a. There is duplication of DNA and chromosomes so as to double their amounts i.e. there is replication of DNA and chromosomes.

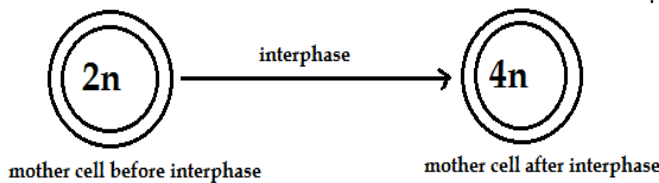
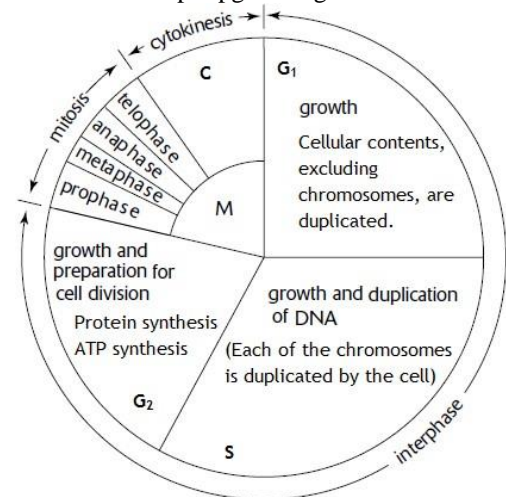

Diagram showing the cell cycle

Soper pg 779 fig 23.5



- b. In addition replication of the centrioles occurs in animal cells.
 - c. There is synthesis of a lot of ATP so that there is sufficient energy for the next cell division.
 - d. There is replication of cell organelles like mitochondria, endoplasmic reticulum, and Golgi body e.t.c.
 - e. There is synthesis of histone proteins, RNA and other types of proteins occurs
 - f. The chromosomes are seen as tiny thread like structures that are highly coiled and therefore described as invisible (as their details cannot be clearly seen)
 - g. The nucleus becomes enlarged and thin
- Interphase is divided into three stages, namely first growth (**G₁**) phase, synthesis (**S**) phase and second growth (**G₂**) phase. The following occur at each stage of interphase

G ₁ phase	S phase	G ₂ phase
<ul style="list-style-type: none"> - Intensive cellular synthesis occurs in which many new cell organelles are made - metabolic rate increases -the cell grows - All chromosomes exist in single chromatid form as they are uncoiled. - Centriole replication starts 	<ul style="list-style-type: none"> -DNA & chromosome replication occurs -histone proteins are synthesised - Chromatids (sister chromosomes) are formed from a single chromosome. 	<ul style="list-style-type: none"> - intensive cellular synthesis - mitochondria replicate - mitotic spindle begins to form - Completion of centriole replication

Note: There are two forms of cell division which occur in both mitosis and meiosis which are;

- a. Nuclear division. This is where the contents of the nucleus divide and is distributed in the daughter cells.
- b. Cytokinesis. This is where the cytoplasm content divides and is distributed in the daughter cells.

MITOSIS

This is a type of cell division in which the mother cell divides into two identical daughter cells which are similar to the mother cell with the same number of chromosomes as the mother cells. This implies that mitosis maintains the chromosome number. Mitosis occurs in somatic cells and also can occur in haploid, diploid and polyploidy cells.

Importance of mitosis

- a. It maintains the chromosome number of the daughter cells similar to that of the parent cell i.e. **it creates genetic stability**. The chromosomes in the daughter cell carry the same genetic information in their genes similar to that of the parental chromosomes from where they were formed by replication. The daughter cells are therefore genetically identical to the parent cell and no variation in genetic information can be introduced in mitosis. This result in genetic stability within populations derived from cells made by mitosis.
- b. It promotes **growth and repair of the body** as it increases the number of cells within an organism to cause growth. In addition cells are constantly dying and being replaced by mitosis to form new cells.
- c. It is a basis for **asexual reproduction**.
- d. It promotes formation of gametes in organisms that reproduce by **parthenogenesis** (in animals) e.g. male bees called drones, aphids i.e. the development of an organism from unfertilized eggs e.g. bees, aphids and parthenocarpy in plants e.g. pineapples.
- e. Mitosis **enables regeneration** to occur. During regeneration, some animals are able to regenerate (re-develop) whole parts of their bodies such as legs in crustacean and arms in starfish.

STAGES OF MITOSIS

The stages of mitosis include the following;

- 1. Prophase
- 2. Metaphase
- 3. Anaphase
- 4. Telophase

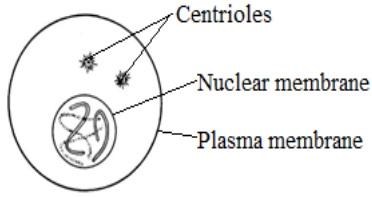
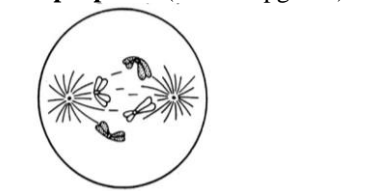
PROPHASE	
<p>This is the longest stage of cell division. It is sub-divided into two sub stages, early prophase and late prophase. During early prophase the following changes occur in the cell;</p> <ul style="list-style-type: none"> i. Establishment of the poles and migration of the centrioles to opposite poles of the cell. In case of animal cells. ii. The centrioles begin to synthesis spindle fibers that grow towards the nuclear membrane. iii. The chromosomes coil and condense (shorten & fatten) and become visible as single threads with bead like structures in the middle known as centromere. iv. The nucleus starts shrinking. 	<p>Early prophase (Roberts pg 368)</p>  <p>Late prophase (Roberts pg 368)</p> 
<p>By the late phase the following changes will have taken place in the cell;</p>	
<p>By the late phase the following changes will have taken place in the cell; Further condensation of chromosomes takes place and each chromosome is seen to consist of a pair of chromatids joined at the centromere i.e. the chromosomes become visible.</p> <ul style="list-style-type: none"> i. The spindle fiber development is completed and these meet at the centre of the cell a point known as the equator of the spindle. ii. The nucleus completely disappears. iii. The nuclear membrane completely breaks down. 	

Note:

- An aster refers to a radial array of short microtubules that extend from a centromere to the cell surface.
- Spindle fibres originate from Golgi apparatus in plant cell
- A centrosome is a non-membranous region at the pole of the cell containing centrioles which organizes the microtubules of the cell

METAPHASE

This is the second stage of mitosis also having early metaphase and late metaphase. During this stage the chromosomes line up at the equator of the spindle independently attached by their centromere to the spindle fibers i.e. homologous chromosomes do not associate together.

At late metaphase the sister chromatids slightly repel each other at the centromere due the contraction of the spindle fibres which also occurs slightly, thereby orienting the chromatids towards opposite poles.

Drawing (Soper pg 780)

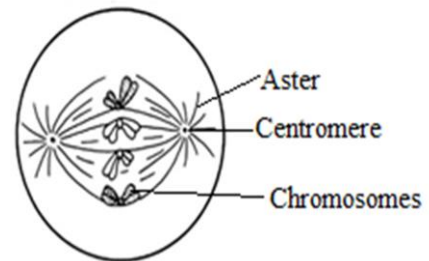

ANAPHASE

This is the third and shortest stage of mitosis. It is divided into early anaphase and late anaphase. During early anaphase, the centromere split and the spindle fibers contract and start pulling the daughter centromeres formed together with the sister chromatids attached to opposite poles of the cell, the fibres continue coiling thereby becoming shorter and this process uses a lot of energy in form of ATP.

By late anaphase the chromatids will have reached the poles of the cell.

Drawing (Soper pg 780)

Anaphase

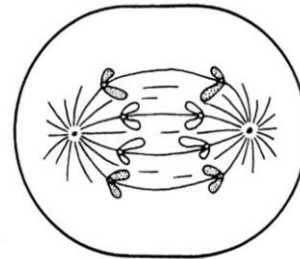

TELOPHASE

This is the last stage of mitosis and it involves the following changes;

- i. The chromatids at the pole uncoil and lengthen to form chromatin and become invisible again i.e. the chromatids become chromosomes which uncoil and gain their thread like nature
- ii. The nucleolus and nuclear membrane reappears.
- iii. The spindle fibers breakdown
- iv. A nuclear membrane reforms around the chromosomes at each pole.
- v. The cell constricts in the middle which separates the mother cell into two daughter cells each having the same number of chromosomes as the mother cell.

Drawing (Soper pg 780)

Telophase

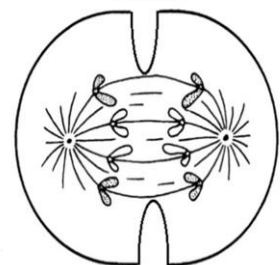

Cytokinesis

Separation of the mother cell into two daughter cells including the division of the cytoplasm is described as cytokinesis. Cytokinesis in animal cells is brought about by the alignment of the micro filament in the middle of the cell. When the microfilament contract, a furrow is formed from either side of the cell and when these furrows become big enough, the mother cell divides into two daughter cells.

Cytokinesis in plant cells

Mitosis in plant cells is similar to that in animal cells except that,

- i. Plants do not have centrioles and their spindle fibers are produced by the Golgi body
- ii. Cytokinesis in plants does not involve formation of furrows but instead a primary cell wall develops in the middle of the mother cell to separate it into two daughter cells.
- iii. The development of the primary cell wall begins with small vesicles that line up across the mother cell and eventually fuse together to form a cell plate which later becomes the primary cell wall

During telophase in plant cells, the vesicles derived from the Golgi apparatus move along microtubules to the middle of the cell where they fuse together to produce a cell plate. The cell wall materials carried in the vesicles collect in the cell plate as it grows. The cell plate then enlarges due to these materials until its surrounding membrane fuses with the plasma membrane along the perimeter of the cell. Two daughter cells result each with its own cell membrane and a new cell wall arising from the contents of the cell plate separates the two daughter cells.

COMPARISON OF MITOSIS IN PLANTS AND ANIMALS

Similarities	Differences	
In both: i) Spindle fibres form ii) During Prophase, chromosomes condense iii) Before metaphase, the nuclear envelope breaks down. iv) Spindle attaches to chromosomes at centromeres v) At metaphase, the chromosomes align at the equator vi) At anaphase, chromosomes move towards opposite poles vii) At telophase, the nuclear envelope appears again, chromosomes de-condense, and the spindle breaks down	Mitosis in animal cells	Mitosis in plant cells
	Occurs almost all over the body	Occurs at apical, lateral and intercalary meristems only
	Centrioles present	Centrioles absent
	At telophase a contractile ring of actin and myosin forms halfway between the two nuclei.	At telophase a phragmoplast of actin, myosin, and microtubules, forms at the future site of cell wall.
	Cytokinesis occurs by cleavage	Cytokinesis occurs by cell plate method
	Cell becomes rounded before division	Cell shape does not change before division
	A furrow is formed between two daughter cells	A solid middle lamella forms between two daughter cells
	Mitotic apparatus contains asters	Mitotic apparatus lacks asters
	Spindle degenerates at cytokinesis	Spindle in form of phragmoplast persists at cytokinesis
	Several hormones induce cell division, not one specifically	It is induced by a specific hormone called cytokinin

MEIOSIS

<p>This is the form of cell division in which the diploid mother cell undergoes two successive nuclear divisions to form four haploid daughter cells which are genetically different from each other and also have half the number of chromosomes of the mother cell. Meiosis occurs in gonads (gamete producing cells called germ cells) such as ovaries in females and testes in males where the diploid germ cells produce gametes which are haploid. Therefore meiosis occurs during gametogenesis in animals and also during spore formation in plants as well as formation of gametes in flowers (pollen grains and the ovules). A gamete is sexually reproducing cell which cannot develop further unless it fuses with another gamete cell</p> <p>Importance of meiosis</p> <ol style="list-style-type: none"> 1. It leads to the production haploid gametes in sexual reproduction. 2. It brings about genetic variation among organisms which is a raw material for evolution of new species. 	<p>Soper pg 783 fig 23.10</p>
--	-------------------------------

3. It maintains the diploid chromosomes number of organisms by ensuring that doubling of chromosomes at each succeeding generation does not occurs. When gametes with haploid number of chromosomes fuse together at fertilization to form the zygote, the diploid number is restored in the offspring form

STAGES OF MEIOSIS

Meiosis is sub divided into two phases i.e. meiosis I (first meiotic division) and meiosis II (second meiotic division), each of which is subdivided into four stages namely: prophase, metaphase, anaphase and telophase.

MEIOSIS I

1. Prophase I

This is the longest part of meiosis 1 and it is subdivided into five sub stages namely;

- a. Leptotene (b) Zygotene (c) Pachytene (d) Diplotene (e) Diakinesis

a. Leptotene

This is the first step of prophase I and it involves the following changes

- Establishment of the poles of the cell
- The centrioles migrate to opposite poles of the cell
- The centrioles begin to synthesize spindle fibres
- The chromosome begin to condense and are seen as single threads with beadlike structures in the middle called centromeres
- The nucleolus and the nuclear membrane begin to break down and eventually they disappear completely



b. Zygotene

- In this stage, further condensation of the chromosomes occurs and each chromosome is seen to consist of a pair of sister chromatids joined at the centromere.
- The homologous chromosomes move close to each other, one from the male parent and the other pair from the female parent.
- The process by which the homologous chromosomes come together in prophase I of meiosis to form a pair of bivalent is known as **synapsis**.
- The homologous chromosomes move close together to form a pair called **bivalent** of which one pair comes from the male parent and the other pair from the female parent. (Soper pg 784 fig 23.11) (a)



(Soper pg 784 fig 23.11) (b)

c. Pachytene

- At this sub stage the homologous chromosomes repel each other and are partially separate but remain joined together at a point called **chiasma**.
- In this stage the non-sister chromatids of the homologous chromosomes overlap and join together at points known as chiasmata. At the chiasmata the non-sister chromatids break as the homologous chromosomes continue repelling each other and then the broken segments portions which contain genes are exchanged between the non-sisters chromatids to form new chromosomes.



(Soper pg 784 fig 23.11) (c)

This process by which the non-sister chromatids break and exchange their genetic material is known as **crossing over**. This is the basis for genetic variation among the gametes and among the offsprings that are formed later. During crossing over, the genes from one chromosome are exchanged with the genes from the other chromosome in a pair, leading to a new combination of genes in the resulting chromatids.

<p>d. Diplotene In this stage, the chromatids of homologous chromosomes continue to repel each other and this makes bivalents to assume</p>	<p>e. Diakinesis (Terminalisation) During diakinesis continued repulsion of homologous chromosomes occurs between the homologous chromosomes that are still fixed by chiasmata, this pushes the chiasmata towards the ends</p>	<p>After terminalisation, the chromosomes completely separate and this marks the end of prophase I.</p>
--	---	---

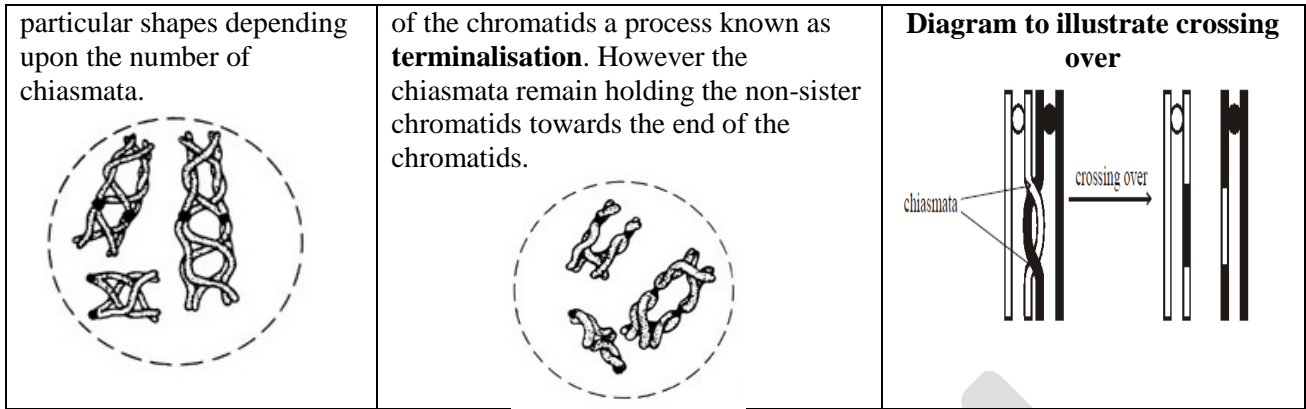

1. Metaphase I

During this stage, the homologous chromosomes line up together at the equator of the spindle in form of bivalents. The chromosomes occupy one spindle fibre at the equator of the spindle and so the chromosomes are said to have associated.

Drawing

(Soper pg 785 fig 23.11) (e)

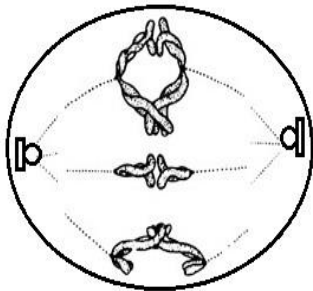

During this stage chromosomes are distributed randomly at the equator of the cell and **segregate (separate) independently** which leads to the mixing of genes in the daughter cells formed at the end of meiosis. This results into genetic variation.

2. Anaphase I

The spindle fibers undergo spiral coiling thereby pulling the homologous chromosomes on them to opposite poles due to contraction of the proteins that make up these fibres. The homologous chromosomes part company and move towards the pole of the cell. By late anaphase I, the chromosomes will have reached the poles.

Drawing

(Soper pg 785 fig 23.11) (f)

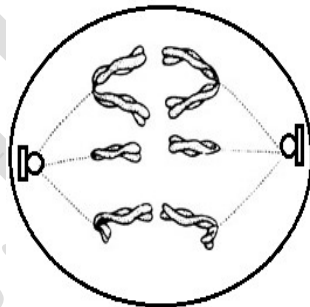

3. Telophase I

This stage occurs when homologous chromosomes arrive at the poles. The following events take place;

- The mother cell constricts to divide into two daughter cells.
- Homologous chromosomes regain their thread-like nature at the poles and become invisible again
- The nucleolus and the nuclear membrane reappear so as to enclose the chromosome.
- The spindle fibers breakdown and cytokinesis then occurs as in mitosis.

This halves the diploid chromosome number into the haploid number into the two daughter cells. The chromosomes arrange themselves across the middle of the two daughter cells and each daughter cell undergoes a second meiotic division to form two more daughter cells.

Diagram (Soper pg 785 fig 23.11) (g)

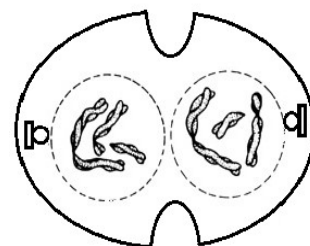

MEIOSIS II

After meiosis II, each of the daughter cells formed enters a short interphase period. During this period, the cells synthesize more ATP and replication of cell organelles such as centrioles occur. **However**, during this interphase period replication of DNA chromosomes does not occur. Meiosis II is also sub divided into four stages namely; prophase II, metaphase II, anaphase II, and telophase II.

The events which occur during meiosis II are similar to those of mitosis as summarized in the diagrams below;

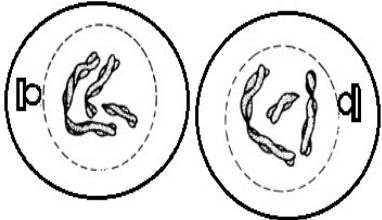
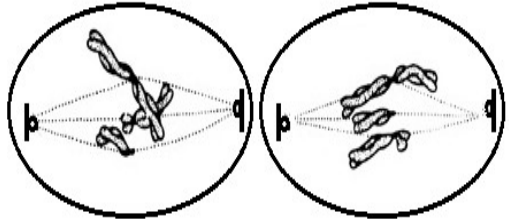
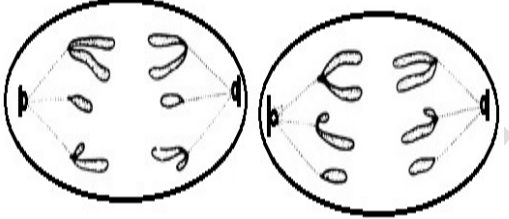
<p>a. Metaphase II The chromosomes line up individually on the equator of the spindle as in meiosis.</p> 	<p>b. Anaphase II The centromeres split and chromatids of the two chromosomes in each cell separate and move to opposite poles due to spiral coiling of spindle fibers.</p> 
<p>c. Telophase II Each cell divides by constricting across in the middle. The chromatids unwind and become indistinct so as to become chromosomes. Four new cells are formed each having half the number of chromosomes compared to the original parent cell. The genetic composition of a chromosome is altered by the crossing over of prophase I and events of metaphase I. As in mitosis the spindle fibers disappear and the nucleus, nucleolus as well as the nuclear membrane reform such that the cells enter interphase.</p> 	

As shown in the diagrams above, the two haploid daughter cells formed in meiosis I immediately undergo metaphase II in most cases, prophase II is very **rare BUT** when it occurs the following events occur;

- The centrioles move to opposite poles
- The nucleolus and nuclear membrane break down
- New spindle fibres are formed in each of the two daughter cells of meiosis I

Meiosis brings about genetic variation in the following ways

- a. By crossing over between homologous chromosomes during the pachytene stage of prophase I which separates linked genes on the chromosomes and rearranges these genes which were originally located on the same chromosome. This leads to a variety of new gene recombinations on the chromosome in the daughter cells which leads to genetic variation.
- b. During metaphase I, homologous chromosomes are distributed randomly at the equator of the cell and aggregate independently leading to the mixing of genes in the daughter cells formed.
- c. It results into the formation of haploid cells (gametes) which when fused randomly at fertilization results into offsprings with different genetic constitution due to the recombination of the parental genes.

COMPARISON BETWEEN MITOSIS AND MEIOSIS

DIFFERENCES	
MITOSIS	MEIOSIS
It results into formation of two daughter cells	It results into formation of four daughter cells
Daughter cells which identical to the mother cell	Daughter cells are different to the mother cell
It occurs in somatic cells during growth and developing and in asexual reproduction	It occurs during the formation of gametes in germ cells
No crossing over occurs	Crossing over occurs.
It occur in haploid, diploid and polyploidy cells	It occurs in diploid cells only

Prophase is sub divided into early and late stages	Prophase I is sub divided into five stages namely; leptotene, zygotene, pachytene, diplotene and diakinesis.
Chiasmata are not formed	Chiasmata are formed
Homologous chromosomes do not associate	Homologous chromosomes associate
There is no formation of bivalents	Bivalents are formed in prophase I.
It involves only one nuclear division	It involves two successful nuclear divisions
It maintains the chromosomes number between the daughter cell and mother cell.	It halves the chromosome number of the mother cell within the daughter cells formed.
It takes a shorter time	It takes a longer time
Chromosomes form a single row at the equator of the spindle during metaphase I	Chromosomes form a double row at the equator of the spindle during metaphase I
Chromatids move to the opposite poles.	Chromosomes move to the opposite poles during meiosis I

SIMILARITIES

Both;

- involve four stages of cell division namely; prophase, metaphase, anaphase and telophase.
- require the interphase period before they occur.
- are energy consuming processes i.e. they require ATP.
- can lead to the formation of gametes.
- involve condensation of the chromosomes.
- involve nuclear division and cytokinesis.

Sample questions

<p>1. The graph below shows how the position of centromeres change during mitosis. Line X is the distance between the centromeres and the ends of the spindle. Line Y is the distance between the centromeres of pairs of chromatids. Measurements started at the beginning of metaphase. (Adopted from Advanced Molecular sciences By Mike Bailey and Keith Hirst, 2nd edition)</p>	<p>(c) Explain the trend in distance represented by</p> <p>(i) curve X (09 marks)</p> <p>From 0 to about 15 minutes the distance between centromeres of chromatids and poles of the cell remains constant; ✓ and relatively long; ✓ because the cell is in metaphase stage chromosomes are at metaphase plate (half-way between the poles); ✓ with sister chromatids still held at centromeres; ✓</p> <p>From about 15 minutes to about 23 minutes the distance between centromeres of chromatids and poles of the cell decreases rapidly; ✓ to 0 μm; ✓ because after splitting during anaphase stage; ✓ sister chromatids are pulled rapidly towards poles by microtubules (spindle); ✓ and eventually arrive at the poles during telophase stage; ✓</p> <p>(ii) curve Y (06 marks)</p> <p>15 minutes to about 23 minutes the distance between the centromeres of pairs of chromatids increases rapidly; ✓ because during anaphase; ✓ the chromatids are pulled apart by spindles; ✓</p> <p>From about 23 minutes to 25 minutes the distance between the centromeres of pairs of chromatids remains constant; ✓ because during telophase; ✓ the centromeres remain the same distance away from each other at the poles; ✓</p>
--	--

<p>(a) How long was; (02 marks)</p> <p>(i) Metaphase? 15 minutes;✓</p> <p>(ii) Anaphase? 8 minutes;✓</p> <p>(b) What was the distance between the poles of the spindle in this cell? (01 mark) 44µm;✓</p>	<p>(d) Explain the variation in the maximum distance achieved in X and Y (04 marks)</p> <p>The maximum distance for Y (between centromeres of sister chromatids) is almost (twice);✓ longer than for X (distance between centromeres of chromatids and poles) ;✓</p> <p>During metaphase, chromosomes are at metaphase plate which is equidistant from either pole of the cell therefore maximum for X is shorter;✓ Maximum for Y is longer since spindles pull chromatids to the extremes of the cell (poles) which are very distant apart;✓</p>
---	---

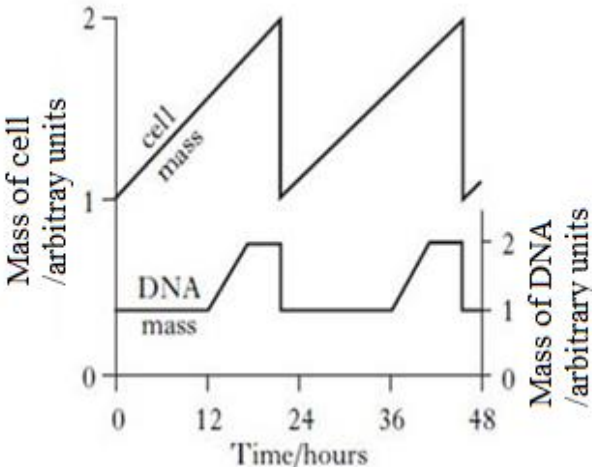
<p>2. The figure below shows changes in the quantities of nuclear DNA and cell mass during repeated cell cycle. (Adapted from BIOLOGY IN CONTEXT For Cambridge International A Level By Glen and Susan Toole)</p>  <p>(a) For one cell cycle only, describe the:</p> <p>(i) Mass of DNA with time (09 marks)</p> <p>One cell cycle lasts from 0 hour to about 23 hours;✓ From 0 hour to 12 hours;✓DNA mass remains constant;✓ From 12 hours to about 18 hours;✓DNA mass increases;✓ From about 18 hours to about 23 hours;✓the DNA mass remains constant;✓ During the 23 hour;✓ the mass of DNA decreases;✓</p> <p>(ii) Mass of the cell with time (06 marks)</p> <p>From 0 to about 23 hours;✓ the cell mass increases;✓ to a peak;✓ During the 23 hour;✓ the mass of the cell decreases;✓</p> <p>(b) For once cell cycle only, compare the mass of the cell and the mass of DNA, with time. (04 marks)</p>	<p>(c) For one cell cycle only, explain the trend in the:</p> <p>(i) Mass of DNA with time (12 marks)</p> <p>From <u>0 hour to 12 hours</u>, the DNA mass remains constant;✓ This the first growth (G₁) phase;✓ cell contents <u>replicate</u> except DNA;✓ From <u>12 hours to about 18 hours</u> the mass of DNA increases rapidly;✓ This is the synthesis (S) phase;✓ DNA <u>replicates</u> to double original mass;✓ From <u>18 hours to about 23 hours</u> the mass of DNA remains constant;✓ This is the second growth (G₂) phase;✓ and mitosis;✓ no DNA synthesis;✓ <u>During the 23 hour</u> the mass of DNA decreases very rapidly;✓ This is because cytokinesis occurs;✓ halving the DNA mass in each new cell to the original mass;✓</p> <p>(ii) Mass of the cell with time (10 marks)</p> <p>From 0 to about 23 hours the cell mass increases rapidly;✓ this marks the period of interphase;✓ and mitosis;✓ during which organelles like mitochondria, cytoskeletal elements, endoplasmic reticula, ribosomes, Golgi apparatus, centriole, e.t.c. <u>replicate</u> and increase in number;✓ and the cell grows (G₁ phase);✓ DNA replicates;✓ and the chromosome content doubles;✓ histones and other nuclear proteins are synthesised (S phase);✓ Synthesis of additional proteins that support cell metabolism occurs (G₂ phase);✓ During the 23 hour, the mass of the cell decreases very rapidly;✓ cytokinesis divides the parent cell into equal sized daughter cells;✓</p>
--	---

GENETICS

This is the study of the mechanism by which characteristics (traits) are transmitted from parents to the offsprings. This transmission occurs via gametes during fertilization in sexually reproducing organisms. Therefore genetics can also be referred to as the study of inheritance characteristics of the parents by the offsprings. The characteristics of organisms are controlled by internal factors called **genes** located on chromosomes. A gene is a section of DNA that determines a particular characteristic in an organization or a section of DNA that controls the production of a polypeptide chain in an organism.

The importance of genetics

- It is used in genetic engineering where better breeds and varieties of plants and animals are produced. This is intended to increase production and improve resistance of diseases and pests. This can be done locally through cross breeding.
- It is used in the legal profession to determine the paternity of the child i.e. genetics is used to settle paternal disputes by confirming who the father of the child is. This can be proved through use of blood groups as these groups are genetically inherited and can therefore be used to prove the rightful father of the child. If the blood groups fail to prove then DNA analysis can be used.
- They are used in blood transfusion. Genetic principals are used during blood transfusion so that blood being transfused is compatible to avoid blood clotting (Agglutination) in the recipient.
- It is used in the control of the transmission of genetic diseases. These diseases are genetically engineered e.g. hemophilia, colorblindness, e.t.c. can be eliminated from the human population by following the principles of genetics as these diseases are genetically inherited.
- It can be used in crime investigation i.e. use of the DNA finger prints to identify criminals
- It is used in molecular biology to manufacture artificial enzymes, hormones and vaccines.
- It enables humans to choose the right partners during marriage by choosing those with characteristics for reproduction.

TERMINOLOGIES INVOLVED IN GENETICS

Alleles: These are alternative forms in which the gene can exist but control contrasting features of characteristics. Alleles exist in pairs e.g. consider a gene for height. This gene can be expressed in form of allele as T (for tallness) and t (for shortness). Therefore these two alleles can exist as TT and tt.

Locus (plural loci). This is the position on the chromosome where the genes are located.

Dominant allele. A dominant allele is the one that can express its self phenotypically in both homozygous and heterozygous forms.

Recessive allele. This is an allele that can only express itself phenotypically in the homozygous form as it is suppressed by the dominant allele in the heterozygous form.

Note: Recessive alleles are presented by small letters (lower case) while dominant alleles are represented by capital letters (upper case)

Phenotype. This is the physical or outward appearance of an organism.

Pure breeding (breeding true). This is where the individuals crossed are homozygous and therefore produce consistently the same characteristic, generation after generation. A pure breed should therefore be a homozygous individual when considered for a particular characteristic

Crossing(X). This refers to the mating of the male and female organisms under a consideration.

Homozygous. This is a condition where an individual possess identical alleles for a particular gene e.g. homozygous dominant (YY, TT, AA) or homozygous recessive (yy, tt, aa)

Heterozygous. This is a condition where an individual possess non-identical alleles for a particular gene e.g. Tt, Bb. Heterozygous individuals are genetically called carriers of the recessive characteristic Recessive characteristics can only be expressed when two carriers make an organism which is phenotypically recessive e.g. the sickle cell anemia individuals, albinos, hemophiliac e.t.c

Hybrid. This is heterozygous individual obtained from crossing two parents with contrasting characteristics but when these parents are pure breeding e.g. tt X TT

First Selfing. This refers to the crossing of offsprings of the same parents.

Filial generation (F₁). This refers to the set of offsprings obtained from crossing two pure breeding parents with contrasting characteristics. These individuals are therefore heterozygous or hybrids.

Trait. Each variant for a characteristic e.g. short stem or tall stem for pea plant. Height is the trait.

Second filial generation (F₂). This refers to the set of offsprings that are obtained from crossing mature hybrid of parents of the first filial generation.

Test cross. This is the mating of a phenotypically dominant individual with a recessive individual so as to determine the genotype of the phenotypically dominant individual. This is due to the fact that a phenotypically dominant individual can either be heterozygous or homozygous. If the homozygous offsprings resemble the dominant parent then the dominant parent is said to be homozygous and if the offsprings formed from the test cross shows a phenotypic ratio of **1:1 (test cross ratio)**, then the parent with an unknown genotype is heterozygous.

Back cross. This is the mating of an offspring with one of its parent so as to prove the genotype of the parents.

Reciprocal cross. This is a cross in which the phenotypes of the same characteristics are interchanged among the parents during a genetic experiment

Cistron. A length of DNA containing a specific sequence of bases that encodes a mRNA molecule controlling formation of a specific polypeptide chain or protein

MENDEL'S GENETIC EXPERIMENTS AND MONOHYBRID INHERITANCE

This is the inheritance of a single pair of characteristics from the parent to offsprings. Examples include, height, blood groups, albinism, sickle cell anemia, and sex linked characteristics e.t.c.

This mechanism of inheritance was discovered by a scientist called Gregory Mendel who carried out a number of genetic experiments using the garden pea plants. He also observed many sexually reproducing organisms and found out that they had variations among themselves despite being of the same species.

In these experiments, Mendel carried out cross pollination between tall pea plants and short pea plants he had grown in his garden. In order to carry out a proper cross, Mendel covered the stigma of all flowers of one group of pea plants in order to have male pea plants. He also removed all the antlers from the flowers of another group of pea plants in order to have female pea plants. Using a brush he transferred pollen to tall pea plants from short pea plants. He observed the **F₁** offsprings were all tall. He then selfed the **F₁** pea plants to get **F₂** which was found to be a mixture of tall pea plants and short pea plants.

Conclusions from Mendel's experiments

About the actual mechanism of inheritance

1. The phenotypic characteristics are under the control of internal factors (these factors were later named genes).
2. It is these factor that are transmitted from the parents to the offsprings i.e. (from one generation to the next).
3. For each character, an organism inherits from the parents two alleles (internal factors), one from each parent and it is these factors which account for variations in inherited characters.
4. The factor which phenotypically appears in **F₁** generation is dominant to the one which fails to phenotypically in **F₁** but instead appears in the **F₂** generation.
5. During sexual reproduction the egg cell and the sperm makes equal contribution to each of the characteristics of the offspring such that the offspring has both male and female parental characteristics. This is because the two alleles for a heritable character separate or segregate during formation of gametes in meiosis and end up in different gametes.
6. Always in **F₂** generation, the dominant and recessive offsprings appear in a phenotypic ratio of 3:1. The results, using proportions only, are summarised in the table below;

Character	Type of cross	F ₁ generation	F ₂ generation	Ratio
Stem length	Tall X Short	All tall	787tall, 277short	2.84:1
Cotyledon colour	Green X Yellow	All yellow	6022yellow, 2001green	3.01:1
Seed type	Smooth X Wrinkled	All smooth	5474 smooth, 1850wrinkled	2.96:1
Seed coat	Coloured X White	All coloured	705 coloured, 224 white	3.15:1

Pod colour	Green X Yellow	All green	428 green, 152 yellow	2.82:1
Pod shape	Inflated X Constricted	All inflated	882 inflated, 299 constricted	3:1
Flower position	Terminal X Axial	All axial	651 axial, 207 terminal	3.14:1
Flower colour	Purple X white	All purple	705 purple, 224 white	3:1

Mendel was successful in his genetic experiment because;

- He had a systematic approach to his work. This is because he dealt with a single characteristic (monohybrid inheritance) and then later on he considered two characteristics simultaneously (di-hybrid inheritance).
- He was very patient during his experiments so that he was able to reproduce the garden peas for several generations.
- He used a very good experimental organism, the garden peas (*Pisum Sativum*).

In order to perform good genetic experiments, Mendel used a garden pea plant because such plants have good characteristics for genetic experimentation which included the following;

- They have many distinct contrasting characteristics without any intermediates such as tall and short stems, smooth and wrinkled seeds, yellow and white flowers i.e. a good genetic organism must show many discontinuous variation characteristics
- They produce large numbers of offsprings which provide a large sample for experimentation so as to get reliable results.
- It is possible for them to undergo controlled pollination.
- They are so small that they can be conveniently handled.
- They have a short life span and they can be reproduced very quickly before the end of the investigator's life span.
- Pure breeds were easily obtained

The seven character differences studied by Mendel

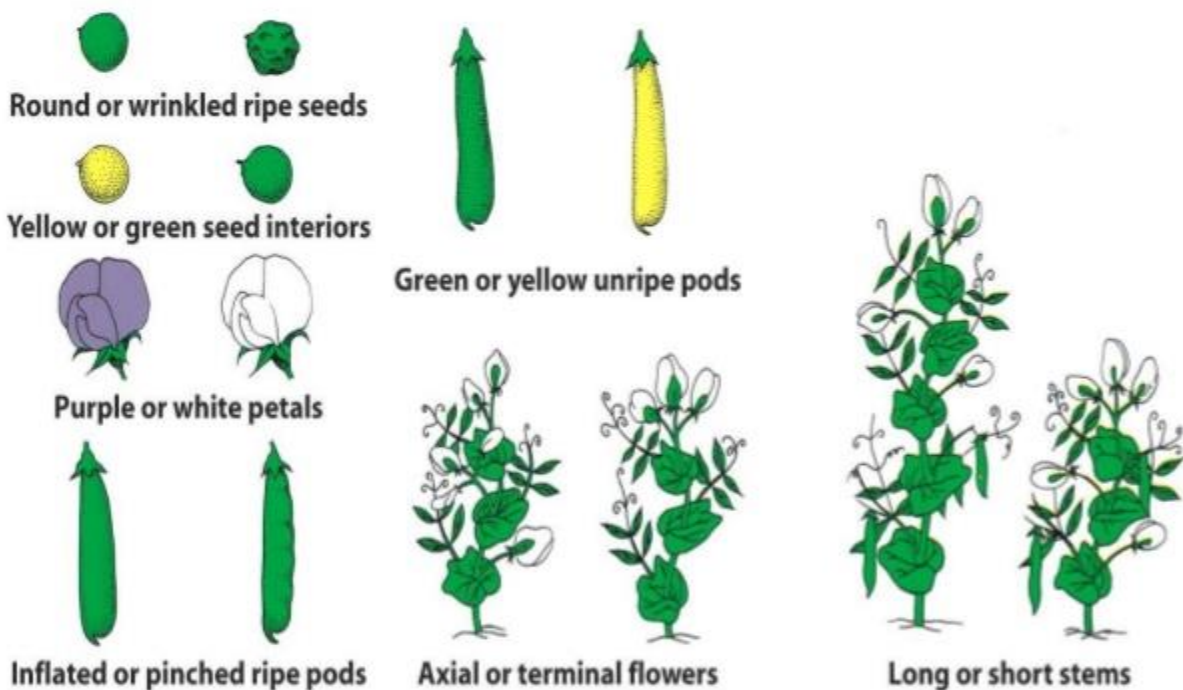

Currently there are two organisms which are also frequently used for genetic experiments. These are *Drosophila melanogaster* and *Neurospora crassa*.

1. *Drosophila melanogaster* (fruit flies)

- The diploid nucleus contains only four pairs of chromosomes
- The larvae have giant chromosomes in salivary glands. These chromosomes have numerous dark transverse bands which are useful in the study of chromosomal mutations.
- The flies are **easily cultured** in small bottles containing simple growth medium. They have a **short life cycle**, each cycle is completed in about 10 days. They **can produce a large number of offsprings**.
- The flies have many distinct characteristics which are easily mutated and thus can be used for genetic studies. For example, body colour, eye shape and wing length.
- Males and females are easily distinguished. Controlled mating experiments and counting of flies can also be carried out easily.

2. *Neurospora crassa* (Bread fungus)

- The fungus can be grown in a minimal medium containing sucrose, inorganic salts and the growth factor biotin.
- It has a relatively **short life cycle**.
- The diploid nucleus contains only seven pairs of chromosomes. **Gene positions** on the chromosomes **can be mapped easily**.
- The haploid ascospores occur in linear series in the narrow tubular ascus and can be dissected out and grown individually.
- Most of the lifecycle occurs in the haploid stage and recessive gene are easily detected

Note. The choice of such experiments depends on a number of factors;

- easy to breed – must readily produce offsprings and not be particular with whom they breed
- readily grown/cultured/reared – the organisms should be convenient and easy to keep
- cheap and easy to breed – they should not have highly specific nutritional requirements
- small size – it follows that the smaller the organism the more likely the previous conditions are to be met
- short life cycle – this allows many generations to be investigated in a short period
- production of many offspring – to give statistically accurate results large numbers of offsprings need to be produced from each mating
- early sexual maturity – this allows more rapid production of subsequent generations
- obviously recognizable feature – genetic differences should be easy to observe
- sexual dimorphism – it is helpful if the male and female of the species are quickly and easily distinguished

MENDEL'S FIRST LAW OF INHERITANCE

Diagram Roberts page 453 fig 28.4

From this experiment about monohybrid inheritance he suggests the law of genetics which is known as the **law of segregation**.

This law states **that in diploid organisms each characteristic is controlled by a pair of alleles but during gamete formation the alleles separate so that each gamete possesses a single allele**.

Explanation of Mendel's first law of inheritance

This law is explained by meiosis which halves the chromosome number in that each characteristic of an organism is determined by a pair of alleles located on the pair of homologous chromosomes in the nucleus of the cell of an organism.

Carriers and genetic diseases

A genetic disease is an illness that is caused by a gene. Most of the 400 genetic disease are caused by a recessive allele of a gene. The diseases only develops in homozygous recessive individuals. Heterozygous individuals do not show any symptoms of the diseases but can pass on the recessive allele to their offsprings. These individuals are called **carriers**. Genetic diseases due to recessive alleles usually appear unexpectedly since both parents **must** be carriers (they do not show symptoms of the disease) they are unaware of this. The probability of these parents having a child with this disease is 25%. Dominant alleles cause very few genetic diseases. Carriers of such genes also suffer from the diseases. If one parent has the disease, the chance of inheriting it is 50 percent. Carriers are individuals who are heterozygous for an undesirable allele.

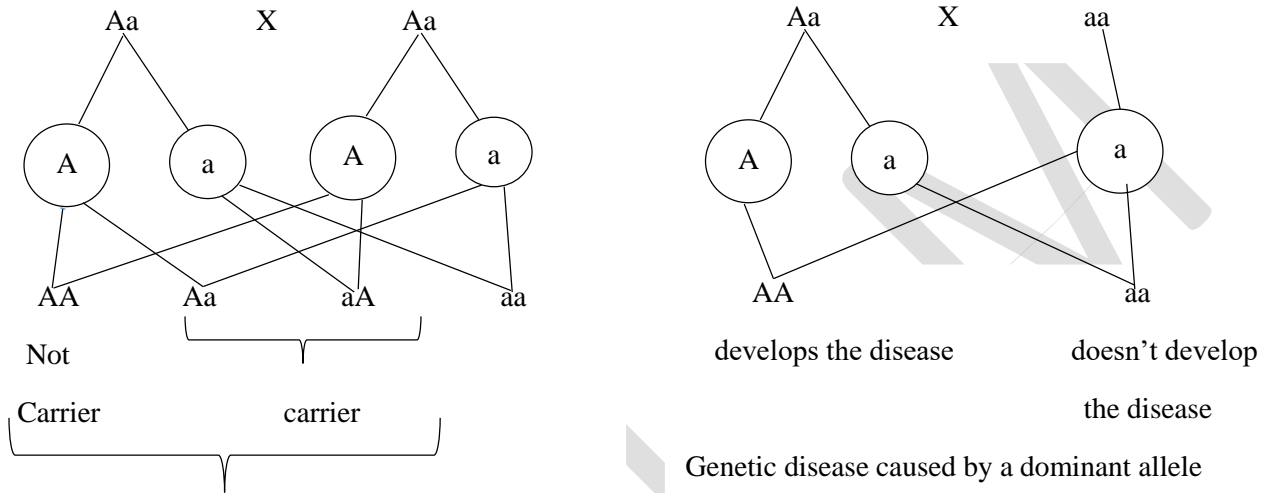

Does not develop the disease

Genetic disease caused by a dominant allele

- a) Albinism is a monohybrid condition due to lack of melanin pigment in the skin. It arises due to a mutation which alters the gene responsible for the synthesis of melanin. This makes an albino to have white hair, very light coloured skin and pink eyes.



- b) Most genetic diseases reduce the chances of survival and reproduction, so the alleles causing them are not usually passed on to offsprings and remain very rare. There is a small number of genetic diseases where the frequency of the allele causing them is much higher. In these cases the allele must confer an advantage, causing its frequency to increase by natural selection. Sickle cell is an example of this

Worked example

- A man with normal skin marries a carrier for albino skin.
 - What is the probability that some of their children will be albinos?
 - What is the probability that the second born child will be a carrier?

Lethal genes in mice

The gene that determines coat color in mice is a zygotic lethal gene. In mice, there are two colours determined by these genes i.e. yellow and grey (agouti). If two yellow mice are crossed they produce both yellow and grey offspring however these offspring appear in a phenotypic ration of **2 yellow: 1 grey** instead of 3:1.

This is because the homozygous dominant yellow mice die in the uterus which reduces the phenotypic ratio. The yellow mice produced are always heterozygous and this changes the monohybrid genotypic ratio from 1:2:1 to 2:1. This is shown using the genetic symbols below;

.....
.....
.....
.....
.....
.....
.....
.....
.....
.....
.....
.....
.....
.....
.....
.....
.....
.....
.....
.....
.....
.....
.....
.....

Note

- a) Dominant lethal genes are very rare in a population because they are usually manifested easily in growth and development of the offspring at an early age and hence easily eliminated.
- b) A **pleiotropic gene** is the one which controls more than one aspect or characteristic in the metabolism of an organism e.g. the Y gene in mice is controlling both viability and coat colour, for viability the Y gene acts as a recessive gene since homozygous YY mice dies in the uterus and since Yy mice are yellow this phenomenon is called **pleitrophy**.

CO-DOMINANCE

This is a phenomenon whereby the alleles controlling a particular characteristic have equal powers of expressing themselves in the phenotype in the heterozygote. Therefore the offspring produced will have a mixture of the two parental characteristics in the phenotype. Codominance is found in both plants and animals.

Co-dominance is taken to be a form of incomplete dominance since no allele suppresses the phenotypic expression of another. In co-dominance we use capital letter to represent all the two alleles each letter corresponding to each of the two characteristics.

Gametes	R	R
W	RW	RW
W	RW	RW

Examples of co-dominance include the following;

- a. The gene that determines coat color in cattle
- b. Inheritance of blood group AB in man
- c. Inheritance of sickle cell trait
- d. Human MN blood group

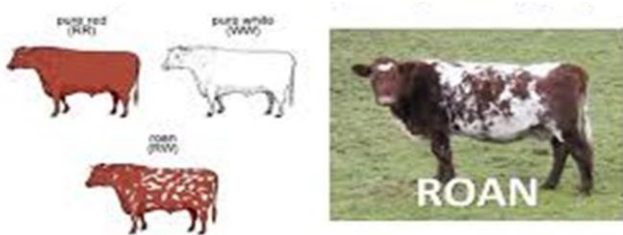

Inheritance of coat colour in cattle

Remember that we cannot use upper and lower case letters for the alleles, as this would imply that one (the upper case) was dominant over to the other (the lower case). We therefore use different letters **R** for red and **W** for white –and use these as superscripts on a letter that represents the gene, in this case **C** for colour i.e. **C^R** and **C^W**

Consider a cross between a red bull and a white cow whose F₁ (spotted) offsprings are selfed. Work out the genotypes and phenotypes in F₁ and F₂ generation stating in each case the ratios

Let **C^R** represents the allele for red colour production in cattle

Let **C^W** represent the allele for no colour production in cattle

.....

.....

.....

.....

.....

.....

.....

.....

.....

.....

.....

.....

.....

.....

.....

.....

.....

.....

.....

.....

.....

.....

.....

.....

.....

.....

.....

.....

.....

.....

.....

.....

.....

.....

.....

.....

.....

.....

.....

Inheritance of sickle cell anaemia

<p>This is an abnormal condition in which the red blood cells collapse into a sickle shape under low oxygen concentration due to the presence of abnormal haemoglobin (Hb^S) in the red blood cells. The normal haemoglobin is found in red blood cells with a bi concave disc shape</p>	<p>Sickle cell anaemia is caused by a substitution mutation on DNA cistron, in the gene that codes for the β-globin in the polypeptide in haemoglobin. A single nucleotide base, Adenine is substituted by the nucleotide base, Thymine.</p>
<p>Drawing</p>	<p>During substitution gene mutation on DNA cistron, adenine replaces thymine in beta polypeptide chain cistron leading to formation of CAT code on the DNA cistron instead of CTT (that codes for glutamic acid). The mRNA formed therefore has a GUA codon which codes for valine instead of GAA codon which codes glutamic acid (responsible for normal haemoglobin in red blood cells). valine leads to the formation of abnormal haemoglobin.</p> <p>The substitution mutation occurs at the sixth amino acid in the β-chain, this results in wrong amino acid, valine, being incorporated into two of the β-polypeptide chains. Valine is non-polar and hydrophobic which makes its presence in the haemoglobin (Hb^S) less soluble when deoxygenated. Therefore when Hb^S loses its oxygen, the molecules come out of solution and crystallise (solidify) into rigid rod-like fibres. The chains of haemoglobin join together into bundles that are rigid enough to distort the red blood cells into a sickle shape.</p>

Effects of sickling red blood cells

- a. Anaemia this is occurs because the sickle cells are destroyed which lowers the amount of oxygen to be carried leading to acute anemia. This leads to;

- Fatigue (weakness)
 - Poor physical development
 - Dilation of the heart which may lead to heart failure
 - Infections which lead to frequent illness
- b. Interference with circulation of blood because the cells get jammed in capillaries and small arteries. This leads to;
- Heart damage which leads to heart failure
 - Lung damage which leads to pneumonia
 - Muscle and joint damage which leads to rheumatism and pain
 - Gut damage which leads to abdominal pain
 - Kidney damage which leads to kidney failure
 - Liver damage
- c. Enlargement of the spleen because the sickle cells collect in the spleen for destruction
The effects above make the homozygous sufferers to often die before reproductive age.

Note: When sickle cells return high in oxygen conditions in the lung, the haemoglobin chains break up and the cells return to their normal shape. These changes occur time after time, as the red blood cells circulate. Both the haemoglobin and the plasma membrane are damaged and the life cycle of a red blood cell can be shortened to as little as 4 days. The body cannot replace red blood cells at a rapid enough rate and anemia therefore develops. This gene can also be described as **pleiotropic** since it has more than one effect in an organism.

In heterozygous individuals, almost half the molecules made are Hb^S and Bb^A i.e. the alleles Hb^A and Hb^S are co-dominant and the faulty Hb^S gene is not recessive in heterozygous but behaves as recessive in homozygous state. Heterozygous people are not affected except at unusually low oxygen concentrations, such as when flying in an unpressurised aircraft or climbing at high altitude. There some of the cells sickle due to crystallization of their haemoglobins. The heterozygous condition is known as **sickle cell trait**. These individuals have a **selective advantage** over non carriers because they are far less susceptible to malaria (the malaria parasite multiplies inside normal red blood cells) so are more likely to survive in malaria infested areas, and pass on their genes to the next generation. A single copy of the sickle-cell allele increases resistance to severe malaria. The final frequency of the gene in the population varies according to the amount of malaria. Both homozygous recessive (sickle cell anaemia) and heterozygotes (sickle cell trait) individuals suffer from severe and mild malaria attacks respectively but sickle cell traits are more resistant to sever attacks of malaria but suffer the resulting mild anaemia.

Using genetic symbols show the offsprings obtained if;

- a) a normal man marries a sickle cell anaemic woman.
 - b) another man who is a carrier of sickle cell anaemia of the same disease maries the same woman.
- Work out the phenotypic and genotypic ratios arising from these two marriages.

.....

.....

.....

.....

.....

.....

.....

.....

.....

.....

Carriers (heterozygotes) of sickle cell anemia show the sickle cell trait, a co-dominant condition, in which most of the red blood cells have normal hemoglobin and only about 40% of the red blood cells have abnormal hemoglobin S. This produces mild anemia and prevents carriers of the sickle cell trait from contracting severe malaria. This is because when the plasmodium that causes malaria enters a red blood cell with hameoglobin S, it causes extremely low oxygen tension in the cell through its aerobic respiration which leads to the cell sickling in heterozygotes. These sickled cells are quickly filtered out of the blood stream by the spleen, thus eliminating the parasites but resulting into mild anaemia.

In humans MN blood group, the blood group is determined by the antigen types on the membrane of red blood cells.

Genotype	Phenotype (antigen on RBC)
$I^M I^M$	Blood type MM (antigen M only)
$I^M I^N$	Blood type MN (antigen M and N)
$I^N I^N$	Blood type NN (antigen N only)

Antigens M and N are found on the surface of red blood cells. These antigens can stimulate production of antibodies when injected into rabbits or guinea pigs. However, humans do not produce antibodies for antigens M and N. The MN blood type is not medically important during blood transfusion.

INCOMPLETE DOMINANCE

This is a condition whereby the characteristics of the alleles blend together to form an F_1 offspring (heterozygous) phenotype which is intermediate between the two parental phenotypes. Therefore the F_1 individuals do not resemble any of the parents. They are as a result of **partial expression** of both the alleles. It can also be defined as a situation with by the heterozygote shows a phenotype **intermediate between the parental phenotypes**.

In incomplete dominance no gene dominates the other in the phenotype but instead forms intermediate phenotypes and are therefore represented using capital letters. Incomplete dominance is found in both plants and animals.

Examples of incomplete dominance are;

- (a) flower colour of *Antirrhinum* (snapdragon)
- (b) flower colour of *Mirabilis jalapa* (4 o'clock flower)

Incomplete Dominance in *Mirabilis jalapa*

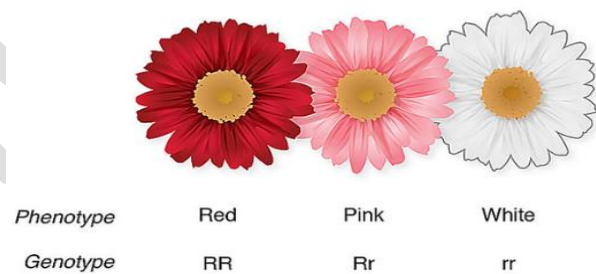

Example

In a snap dragon plant, when a red flowered is crossed with a white flowered plant, all the F_1 plants obtained are pink flowered. When the F_1 are selfed, the F_2 phenotypic ratio is 1:2:1 instead of 3:1. Using suitable genetic diagrams, explain the above results.

.....

.....

.....

.....

.....

.....

.....

Inheritance of ABO blood system

The ABO blood group system is controlled by three alleles of an **autosomal gene I** (isohaemagglutinin) occur at a single locus any time. These alleles are A or I^A, B or I^B and O or I^O. These alleles I^A and I^B are equally dominant while the allele I^O is recessive to both. The transmission of these alleles occurs in a normal Mendelian fashion.

GENOTYPE	PHENOTYPE
I ^A I ^A (AA)	Blood group A (homozygous)
I ^A I ^O (AO)	Blood group A (heterozygous)
I ^B I ^B (BB)	Blood group B
I ^B I ^O (BO)	Blood group B
I ^A I ^B (AB)	Blood group AB (co-dominant)
I ^O I ^O (OO)	Blood group O

The table summarizes the possible phenotype and blood group.

Physiology of the blood groups in humans

Human blood contains blood group antigens and blood group antibodies. Some of these specifically determine blood groups e.g. allele A determines the production of antigen A, allele B determines the production of antigen B and allele O does not code for the production of any antigens. Antigens A and B occur on the plasma membranes of red blood cells. These antigens have corresponding protein molecules known as blood group antibodies (agglutinins) in blood plasma. These antibodies can react with the antigens under the lock and key hypothesis should they be similar to the antigens brought into the recipient's blood, leading to the formation of a precipitate or an agglutinate in blood. **Therefore an individual should not have blood group antibodies corresponding or similar to his blood group antigens in order to avoid agglutination.**

Consequently, individuals should have the following antibodies not corresponding to their antigen to avoid blood clotting.

Blood group	A	A	B	B	AB	O
Antigen	A	A	B	B	AB	None
Antibody	a	a	b	b	None	a and b

Example

1. A man having blood A marries a woman having blood group AB. What are the possible genotypes and phenotypes of their offsprings if the man is heterozygous for blood group A?

.....

.....

.....

.....

.....

.....

.....

.....

.....

.....

- 2. A boy has blood group A and his sister has blood group O. which combination of genotypes and phenotypes do you think their parents have. Show your working.

.....

.....

.....

.....

.....

.....

.....

.....

.....

.....

.....

.....

.....

.....

.....

.....

.....

.....

.....

.....

.....

.....

.....

.....

The importance of blood groups

- a. They are important during **blood transfusion** where they are used to prevent agglutination (precipitation) of blood of the recipient. To avoid agglutination, the donors blood group should be compatible (matching with) to that of the recipient by having the donors blood group antigen that is different from the blood group antibody of the recipient.

When the recipient’s gets antibodies from the donor, such antibodies become diluted in the recipient’s blood and so cause either minor clotting of blood or no blood clotting at all and so cannot lead to death of the recipient. However, in case the donor introduces an antigen that is similar to the antibody of the recipient, it stimulates the recipient’s blood to produce more antibodies which attack and react with the donor’s antigen to cause severe blood clotting. Therefore an individual with a specific antigen on the red blood cell membrane does not possess its corresponding antibody in the blood plasma to avoid agglutination.

Blood plasma permanently contains two blood group antibodies a and b which do not correspond with a specific antigen in blood to avoid agglutination e.g. a person with blood group A has antigen A and antibody to avoid agglutination. A person with blood group B cannot donate blood to a person of blood O because antigen B in the donor’s blood will be attacked by antibody b in the recipient’s blood leading to

agglutination. The same applies to blood group A and blood group AB donors to blood group O recipients.

It is possible for blood group A to donate blood to blood AB, because the donor's blood, blood group A, has antigen A which cannot stimulate the recipient's blood group AB to attack antigen A since blood group AB individuals lack antibodies that can attack antigen A to cause an agglutination.

A person of blood group AB cannot donate blood to a person of blood group O. This is because the donor's blood has antigen A and antigen B, which stimulate the recipient's blood to produce corresponding antibodies a and b, which then attack and react with antigen A and B in the recipient's blood.

Blood group AB individuals can receive blood from all other individuals having other blood groups. Therefore individuals with blood group AB are called **universal recipients**. This is because such individuals have no antibodies in their blood plasma that can react with antigens A and B in the donor's blood.

Individuals with blood group O can donate blood to all other blood groups and are therefore called **universal donors**. This is because blood group O individuals do not have any antigens in their red blood cells that can react with antibodies in the blood plasma of the recipient to cause agglutination.

The table below summarises the possible and impossible blood transfusions.

Recipient		Donor's blood group			
Blood group	Antibody in plasma	A	B	AB	O
A	B	✓	X	X	✓
B	A	X	✓	X	✓
AB	None	✓	✓	✓	✓
O	a and b	X	X	X	✓

✓ = compatible with recipient's blood

X = Incompatible with recipient i.e. agglutination occurs

- b. They are used in **settling court cases** about who the father of the child is (i.e. paternity suits). Although blood groups cannot prove beyond reasonable doubt who the father of the child is it is possible to use their inheritance to show that an individual could possibly be the father of the child.

Consider a mother who is of blood group O having child of blood group O and the child produced also with blood group O. She claims that the father is a man whose blood group is AB. Since the child is blood group O its only possible genotype is $I^O I^O$ and it must therefore have inherited one I^O allele from each parent. Since the man is of blood group AB he cannot donate the I^O to the child and therefore he cannot be the father of the child. Even if the father was found to be of another blood group such as blood group A still the evidence will be insufficient because any other man can possess such a blood group and donate the I^O allele to the child. Therefore a DNA test should be carried out to confirm who the father of the child is.

- c. Blood groups can also be used as an **evidence of evolution**. This is because organisms of different species having similar blood group systems such as the ABO system are believed to have originated from the same ancestor in the course of evolution for example humans, chimpanzees, gorillas, Baboons e.t.c.

THE RHESUS BLOOD GROUP SYSTEM

The rhesus blood group system is also inherited in a similar way to the ABO blood group system. Individuals with red blood cells with the D-antigens (Rhesus factor) are said to be rhesus positive (Rh^+) however Rh^+ allele is taken to be dominant over the rhesus negative (Rh^-) allele. The Rhesus factor is controlled by three alleles C, D and E which determine the production of D-antigens on the surface of the red blood cells. Allele D mainly determines the production of D-antigens and it is this antigen which is the fundamental determinant of blood grouping under the rhesus blood group system.

Marriage complications of the Rhesus system

If an Rh^+ man marries an Rh^- woman, most of their children are likely to die immediately after birth or before birth. The first child usually survives because the time is too short for the mother to produce enough

antibodies known as anti D agglutinins which can pass to the foetus to cause death. If a mother becomes pregnant after the first child, the Rh⁺ foetus formed can die due to antibodies of the mother entering the foetal circulation. This is because during the first pregnancy, especially the time of giving birth, the blood of the child which is Rh⁺ may mix with that of the mother which is Rh⁻, thereby introducing D-antigens in the mother's blood. Also, some of foetal erythrocytes of the first child with D-antigens in them may cross the placenta and enter the body of the Rh⁻ mother towards the end of the gestation period. D-antigens will then stimulate the mother's blood to produce many antibodies called anti D-agglutinins which attack and react with the D-antigens introduced in the mother's blood if the mother becomes pregnant again and the child is Rh⁺. These antibodies in the mother's blood will pass via the placenta and enter the foetal blood circulation, where they will attack and react with D-antigens in the child's blood causing the red blood cells of the child to clump together, this disease is known as **hemolytic disease of the new born** (erythroblastosis foetalis). This results into acute anaemia of the foetus which can lead to death of the foetus. The problem may be solved in two major ways;

- a. The mother may be injected with anti-D-agglutinins in the first 72 hours after her first born so as to make her immune system insensitive towards D-antigens.
- b. By carrying out proper intermarriages where by Rh⁺ man marries Rh⁺ woman and Rh⁻ woman gets married to Rh⁻ woman.

Another blood group system in humans called the MN blood group system is controlled by 2 alleles M and N which are co-dominant. M and N alleles also determine the production of antigens respectively. Individuals therefore have the following genotypes if this blood group system MM, NN, MN.

ASSIGNMENT

1. Suppose a man having blood group A marries a woman who is heterozygous for blood group B what are the possible genotype and phenotypes.
2. A boy has blood group A and his sister has blood group B. what are the possible phenotypes and genotypes of their parents.
3. If a father has blood group A and the mother blood group AB what are the possible genotypes and phenotypes of the offspring.

DIHYBRID INHERITANCE

This type of inheritance whereby two characteristics are transmitted from the parents to the offsprings at the same time

When Mendel considered the inheritance of two characteristics simultaneously, he concluded that these characteristics are inherited independently and each pair of alleles separates during meiosis and during fertilization each of the alleles combines randomly with either alleles of another pair. From this conclusion Mendel made his second law of inheritance which states that; **“each characteristic in diploid organisms is controlled by a pair of alleles which separate so that each allele randomly combines with any other allele of another pair.”**

Mendel also described it as the **law of independent assortment**.

This law is explained by meiosis as follows. During gamete formation, during meiosis, the distribution of each allele from a pair of homologous chromosome is entirely independent of the distribution of alleles of other pairs. During metaphase I of meiosis homologous chromosomes lineup on the equator of the spindle and subsequently separate (segregate) independently during metaphase I and move to opposite poles independently during anaphase I which leads to a variety of allele recombination in the gametes formed, as long as each gamete has one allele for each gene.

Example

In the garden pea plant, the gene controlling flower color is located on the same chromosome with that controlling height. Suppose a pure bleeding tall red flowered plant is crossed with a white short flowered plant, the F₁ offsprings obtained are tall red flowered plants. If the F₁ offsprings are selfed,

This is an incidence where by a 9:3:3:1 phenotypic ratio is obtained for a single characteristic. Although this ratio is this pattern of inheritance differs from the hybrid inheritance because;

- The F_1 progeny (offsprings) resembles neither parents i.e. they are all walnut comb shaped unlike their parents.
- The F_2 progeny also contains two new phenotypes which do not exist in the F_1 parents namely walnut and a single comb shaped and these appear in a higher ratio as compared to the rose and the pea comb

MODIFICATION OF 9:3:3:1 PHENOTYPIC RATIO

This ratio is mainly modified by the inheritance of lethal genes, linkage of genes and epistasis

<p>EPISTASIS This is an example of gene interaction. Epistasis refers to a condition in which non-allelic genes interact during which the epistatic allele of the epistatic gene on one locus suppress the phenotypic expression of the hypostatic allele of the hypostatic gene on another locus and are independently inherited. For example, when genes act in a sequence, as part of a biochemical pathway, an allele that produces a defective enzyme early in the pathway interferes with the expression of another gene hence epistasis. An epistatic allele is the one which suppresses another allele in the phenotype though they are not located on the same locus and the suppressed gene or allele at another locus is the hypostatic one. They are 3 types of epistasis which include the following;</p> <ol style="list-style-type: none"> Dominant epistasis Recessive epistasis Isoepistasis 	<p>Dominant epistasis. This is the type of epistasis where the epistatic allele is dominant such that its presence suppresses the phenotypic expression of the recessive allele on another locus. This type of epistasis changes the phenotypic ratio from 9:3:3:1 to 12:3:1. In Leghorn fowl, there are white and coloured birds. Colour is due to a coloured pigment produced by a dominant allele C. Normally birds are only white when there are two recessive alleles cc for the gene. However, another dominant allele I of a gene on a different chromosome prevents the action of allele C. When the dominant allele C is present with dominant allele I, no pigment is produced and the bird is white. The result of a dihybrid cross between the fowl with the genotype CCII and another with the genotype ccii produces an F_2 generation with the following possible genotypes; CCII, CCii, CcII, CcIi, ccII, ccIi, ccii, which are white and CCii and Ccii which are coloured. From the genotypes above, it can be concluded that a bird possessing both dominant C and dominant I allele will be white as well as genotype ccii. Without epistasis only the genotypes ccII, ccIi and ccii would be white. Recessive epistasis. This is the type of epistasis where the epistatic allele is recessive, such that its presence in homozygous condition, suppresses the phenotypic expression of the dominant allele located on another locus. This type of epistasis changes the dihybrid phenotypic ratio from 9:3:3:1 to 9:3:4. Isoepistasis. This is the type of epistasis in which both alleles and the non-allelic genes have equal powers of suppressing each other in the phenotype. This modifies the dihybrid phenotypic ratio to 15:1</p>
--	--

Examples

In oats the inheritance of color is controlled by the epistatic gene which has two alleles, one allele being dominant for color appearance while the other allele is for no color formation (white or albino) i.e. the hypostatic gene is responsible for color deposition or type of color. Where by black is dominant over white

Consider a cross between homozygous black oat plant with a homozygous white oat plant and then the F_1 plants are selfed to get F_2 .

- Work out the phenotypic ratio of the F_2 generation
- How many individuals are found in each of the phenotypic classes obtained in F_2 if 130 individuals were found in F_2 ?

Inheritance of coat colour in mice is another example of epistasis. Three phenotypes can occur. Most wild mice have agouti (grey) coat colour. However there are some mice with black fur and others have white fur. Fur colour is controlled by a pair of genes present at different loci. The epistatic gene controls the presence of coat colour and has two alleles. The allele for agouti coat colour (A) is dominant to the allele for black (a).

White fur is caused by a recessive allele (w) on a different locus and presence of (W) leads to deposition of colour. Homozygous recessive (ww) mice are white/albinos even if the alleles for coloured fur (A or a) are also present. The colourless precursor molecules are not converted into melanin pigments. Example, determine the probability of obtaining albino mice if black coat coloured (**aaWW**) mouse was crossed with an albino (**AAww**) mouse

.....

.....

.....

.....

.....

.....

.....

.....

.....

.....

.....

.....

.....

.....

.....

.....

.....

.....

.....

.....

.....

<p>1. LINKAGE OF GENES</p> <p>Linked genes are more than two genes located on the same chromosome but controlling different characteristics and are inherited together as a single block.</p> <p>Linkage is the occurrence of more than one gene on the same chromosome which are inherited together along with the chromosome as a single block. There are two types of linkage; autosomal gene linkage, when the genes are on the same autosome, and sex-linkage, when the genes are located on the sex chromosomes, mainly the X chromosome.</p> <p>Linked characteristics are the ones controlled by genes located on the same chromosome and so are transmitted together with the chromosome from generation to generation.</p>	<p>Although these genes occur on the same chromosome, each one controls the specific characteristic irrespective of the other. However, linked genes do not show independent assortment during gamete formation and therefore the phenotypic ratio obtained in F₂ is 3:1 instead of the expected 9:3:3:1 for the two linked characteristics. Sometimes crossing over occurs, thereby separating the linked genes on the chromosomes leading to the formation of recombinant gametes during meiosis and this gives an F₂ phenotypic ratio of 9:3:3:1 for the linked characteristics.</p>
--	---

NOTE: Drawing the chromosome map is also called **gene mapping** where the position of genes are shown on the chromosomes as well as the distance separating with them. Sometimes it is possible to indicate many genes on chromosome and their distances of separation.

Consider the cross over values involving for different genes P, Q, R and S.

The distance separating these four genes is shown below;

P-Q = 24%	R-S = 8%
R-P = 14%	S-P = 6%

Draw the chromosome map to show the position of these chromosomes.

Answer. Draw the chromosome map for these genes

- a. Insert the positions of the genes with the smallest cross over value in the middle of the chromosome map.
- b. Examine the next largest cross over value and insert both possible positions of its genes on the chromosomes relative to either S or P.
- c. Repeat the procedure for all the remaining cross over values until you reach the largest cross over values.

.....

.....

.....

.....

.....

.....

.....

.....

.....

.....

.....

.....

.....

.....

.....

.....

.....

.....

.....

.....

.....

FACTORS THAT AFFECT CROSSING OVER

- 1) **The relative distance between the genes on the chromosome.** When the genes are far apart from each other on the chromosome, they have high chances of forming chiasmata in between thereby leading to genetic exchange on the other hand when genes are very close to each other on the chromosome, their chances of forming chiasmata is limited.
- 2) **The position of the centromere on the chromosome.** If the genes are very close the centromere there chances of undergoing genetic exchange are limited. However, if the genes are far away from the centromere, there are high chances that they can be exchanged by crossing over.
- 3) **Temperature.** Crossing over decreases with increase in temperature because the process of meiosis requires suitable temperature that can promote efficient crossing over.
- 4) **Age of the organism.** Increase in age lowers the chances of crossing over. Meiosis is more efficient in grown up adults before menopause stage in females and before senescence in male.
- 5) **Mutagens.** These can decrease or increase the rate of crossing over. The chances of crossing over are greatly reduced by presence of chemical substances that inhibit chiasmata formation thereby preventing cross over e.g. in drosophila flies.

INHERITANCE OF SEX

The sex of an organism is determined by two factors namely; environmental conditions and genetic factors.

Environmental determination of sex, In lower animals, sex can be determined by environmental factors such as temperature, salinity, type of food e.t.c. for example in tadpoles the eggs laid in cool places develop into males while those laid in warm places develop into females.

Genetic sex determination; the sex organs development can be determined by the sex genes or the chromosomes. Under chromosomal sex determination, sex can be determined by;

- The number of chromosomes. E.g. in bees the females are diploid and have 32 chromosomes while the males are haploid and have 16 chromosome. In grasshoppers the females have 24 chromosomes while the males have only 23 chromosomes.
- The sex chromosomes. In heterogametic organisms,, such as human beings, there are two sex chromosomes that determine the sex of an individual namely the X and Y chromosomes e.g. the females are **XX** and are described as **homogametic** while the males are **XY** and are described as **heterogametic**. Therefore in these organisms it is the presence of the Y chromosome that makes one a male and its absence makes one a female. This implies that it is the type of sperm (whether X or Y) that fertilizes the egg which determines the sex of the offspring.

The **X** chromosome is large with many genes on it that are essential in both male and female development. The **Y** chromosome is smaller, with far fewer genes. Part of the Y chromosome has the same sequence of genes as the X chromosome (homologous part), but the genes on the remainder of the Y chromosome are not found on the X chromosome (non-homologous part) and are not needed for female development.

One gene, the tdf gene, is only found on the Y chromosome. It initiates the development of male features, including testes and testosterone production. The homogametic females lack the Y chromosome with its tdf gene hence ovaries develop instead of testes and female sex hormones are produced instead of testosterone.

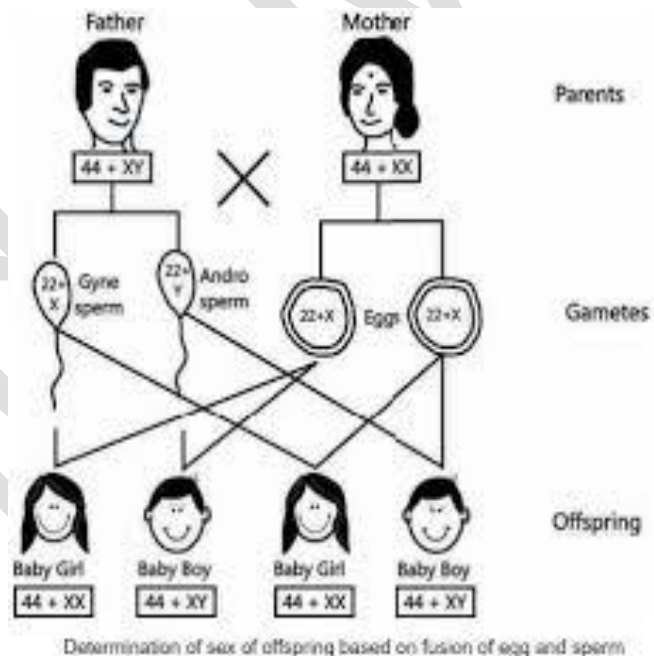

In birds sex is determined by the X and Y chromosomes except that the females are **XY** while males are **XX**.

In grasshoppers sex is only determined by X chromosomes where by the males are XO i.e. they have only one X chromosome (**XO**) while the females are **XX**.

SEX LINKED CHARACTERISTICS

This is the transmission of characteristics (from parents to offsprings) whose genes are located on the sex chromosomes i.e. the genes controlling such a character are transmitted along with those that determine sex on the same chromosome.

Most sex linked characters are controlled by genes located on the X chromosome and very few are controlled by genes located on Y chromosome. Examples of sex-linked characteristics include; haemophilia, colour blindness e.t.c. Sex linked characteristics can therefore be defined as those whose genes controlling them occur on the sex chromosome and yet they do not determine sex.

Sex linked characters are often expressed more in males than females.

This is because the males being heterogametic have a non-homologous portion of the X chromosome while the sex linked allele is located and therefore such an allele cannot be suppressed in the phenotype by any other dominant allele.

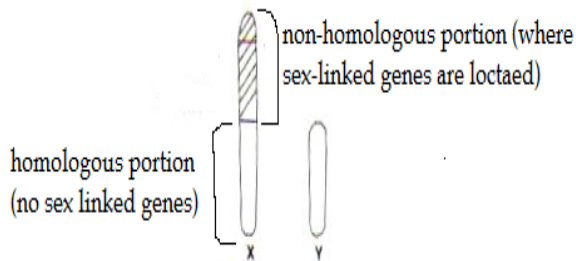

This implies that the genes of the sex linked characters of the males are located in the non-homologous portion and therefore whenever a recessive allele of these characters appears, it has to be expressed in the phenotype since it does not have a counterpart allele that can suppress its phenotypic expression.

In the case of females, the X chromosomes are completely homologous to each other and this gives chances of development of carrier females (heterozygous females) for sex linked characters who may never express the characteristic in the phenotype as the recessive sex linked allele would be suppressed by the dominant allele on the counterpart X chromosome.

Sex linked characters are determined by recessive alleles. However sex linked characteristics undergo a characteristic **cross pattern of inheritance** i.e. the fathers transmit their sex linked characters to their grandsons through their daughters who are carriers this implies that the father will not transmit the sex linked character to his sons but instead to his daughters. This is because the son only inherits the father's Y chromosome and not the X chromosome that controls the sex-linked characteristics.

Although sex linked characters are mostly carried on the X chromosome there are a few of them which are carried on the Y sex chromosome and these are called **holandric characters** i.e. development of many hairs in the nostrils and ears.

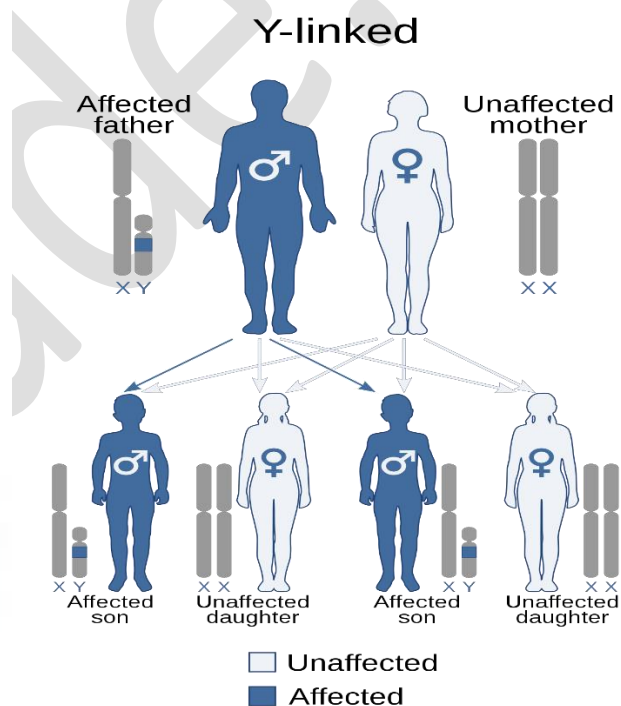
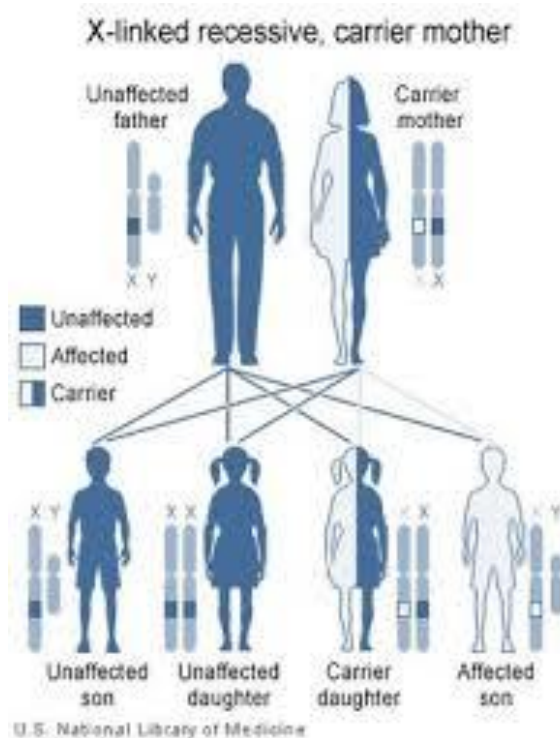

In *Drosophila*, females are XX and males are XY. The gene for eye colour is located on the X chromosome. The wild type flies have red eyes and are either homozygous or heterozygous for the alleles. Male flies are hemizygous, carrying only one allele for eye colour in the single X chromosome. When mutant white-eyed female *Drosophila* flies are crossed with wild-type (red-eyes) male, all the F₁ male offspring have white eyes while the female offsprings have red eyes.

Let R represent the allele for red eyes

Let r represent the allele for white eyes

Let X^R represent the X chromosome with the allele for red eyes

- 2. The females rarely survive beyond their first menstrual periods
- 3. Today people with haemophilia are treated with intravenous injections of the missing protein

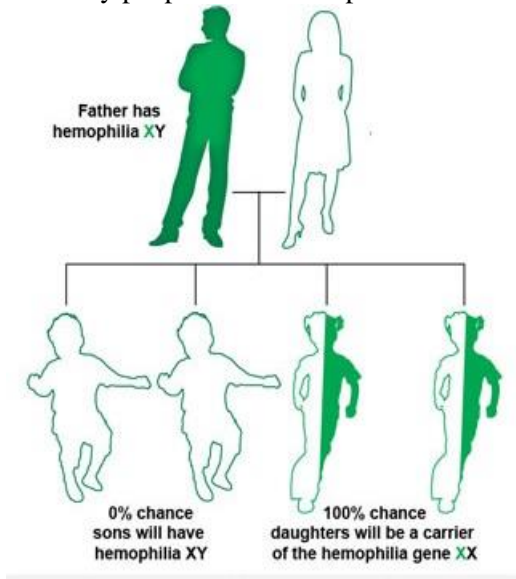

Color blindness is a condition whereby an individual fails to see the colors or fails to distinguish between particular colors e.g. red, green color blindness where the red and green cone cells of the eye retina are defective due to some sex linked gene in an individual which does not allow such an individual to distinguish between red and green. Colour blind individuals are more common in the population than haemophiliacs because haemophiliacs have higher chances of dying before reaching reproductive age to pass on their genes to the next generations whereas colorblind individuals survive and reach reproductive age in most cases which enables them to reproduce and pass on their gene of colour blindness to the next generation which increases their number in the population. Besides, haemophiliac people may both choose not to marry due the lethal gene they have, thereby becoming unable to pass on their genes to the next generation.

Example 2

Green color blindness is sex linked in man. A normal man married a color blind woman. Using suitable genetic symbols work out the genotypes and phenotypes of their children?

.....

.....

.....

.....

.....

.....

.....

.....

.....

.....

.....

.....

.....

.....

.....

.....

.....

.....

.....

.....

.....

.....

.....

Pedigree charts

Pedigree analysis is a systematic listing (using symbols or words); to trace the ancestors of a give individual, of a ‘family tree’ for a large number of individuals, of the genetic pattern of inheritance of a particular characteristic. Various symbols are used in pedigree charts

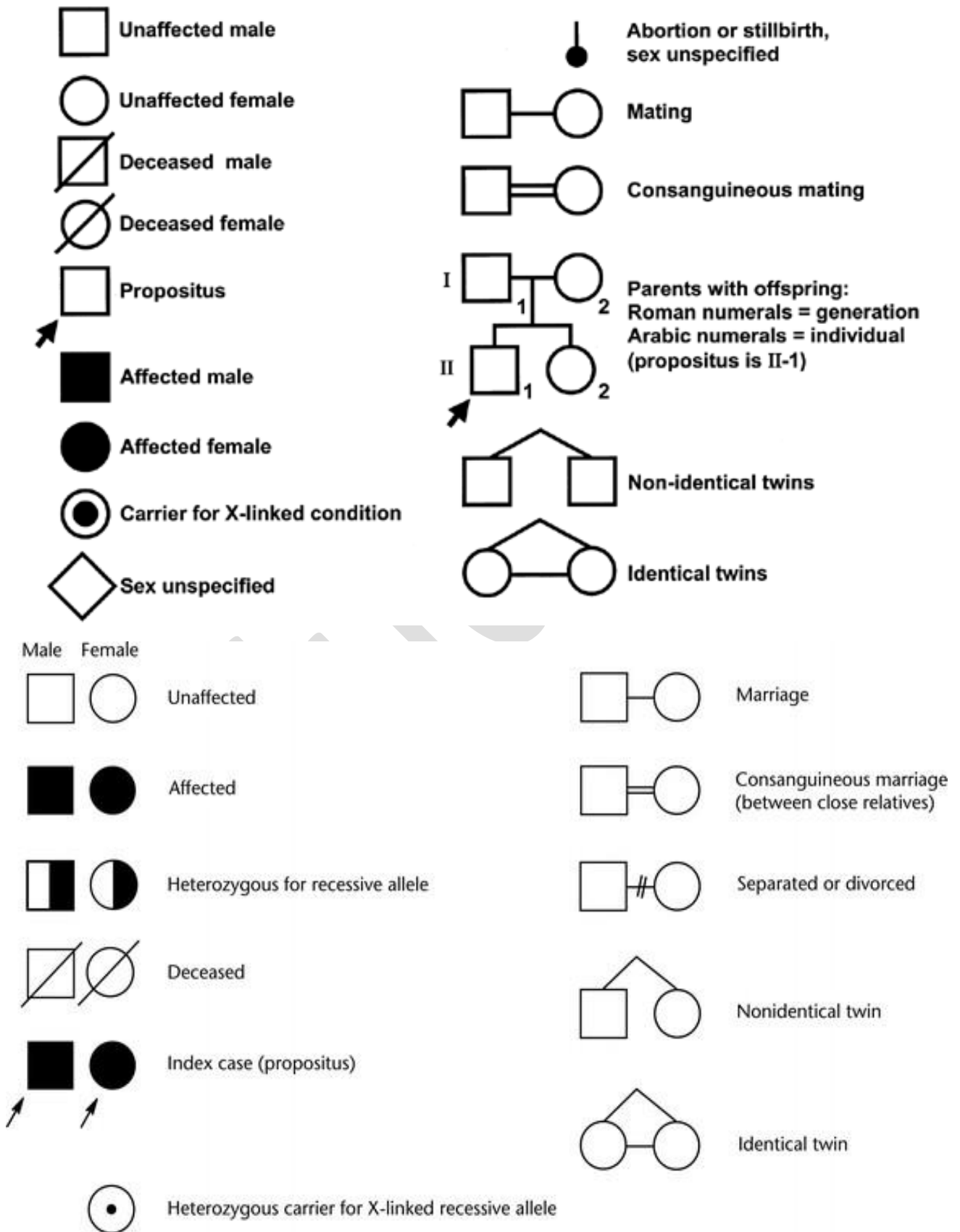

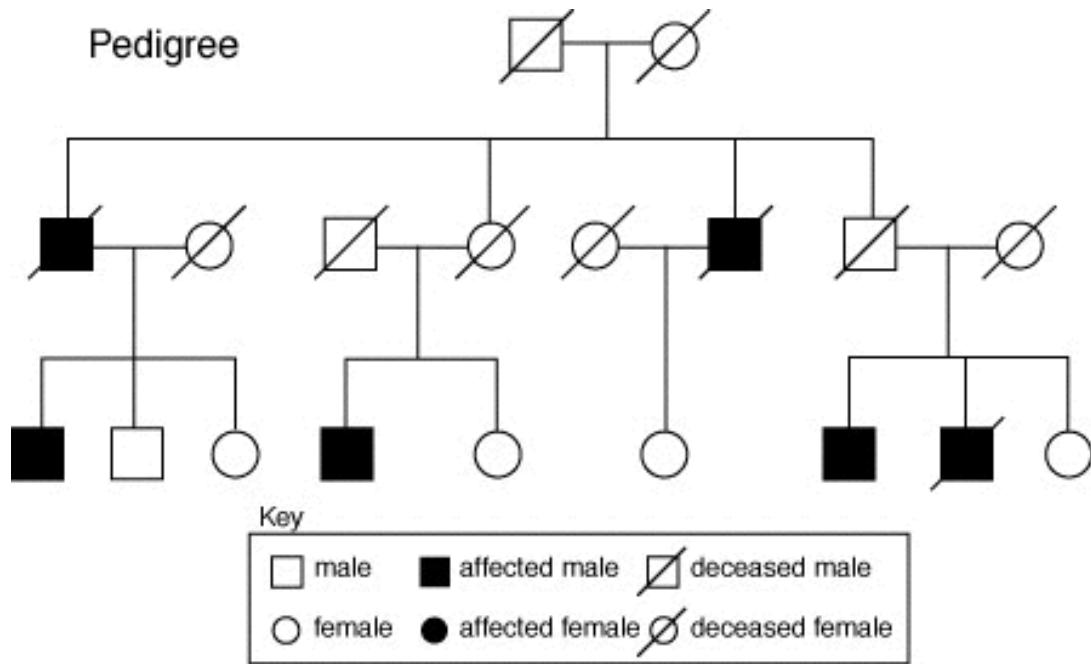

Inheritance of sex-linked characters are traced by use of pedigree charts. In these a male is represented by a square and a female by a circle. Shading within either shape indicates the phenotypic presence of a character such as haemophilia. A dot within a circle signifies a normal phenotype who carries the allele for non-production of factor VII.

A famous pedigree chart showing the inheritance of haemophilia from Queen Victoria in members of various European royal families is shown

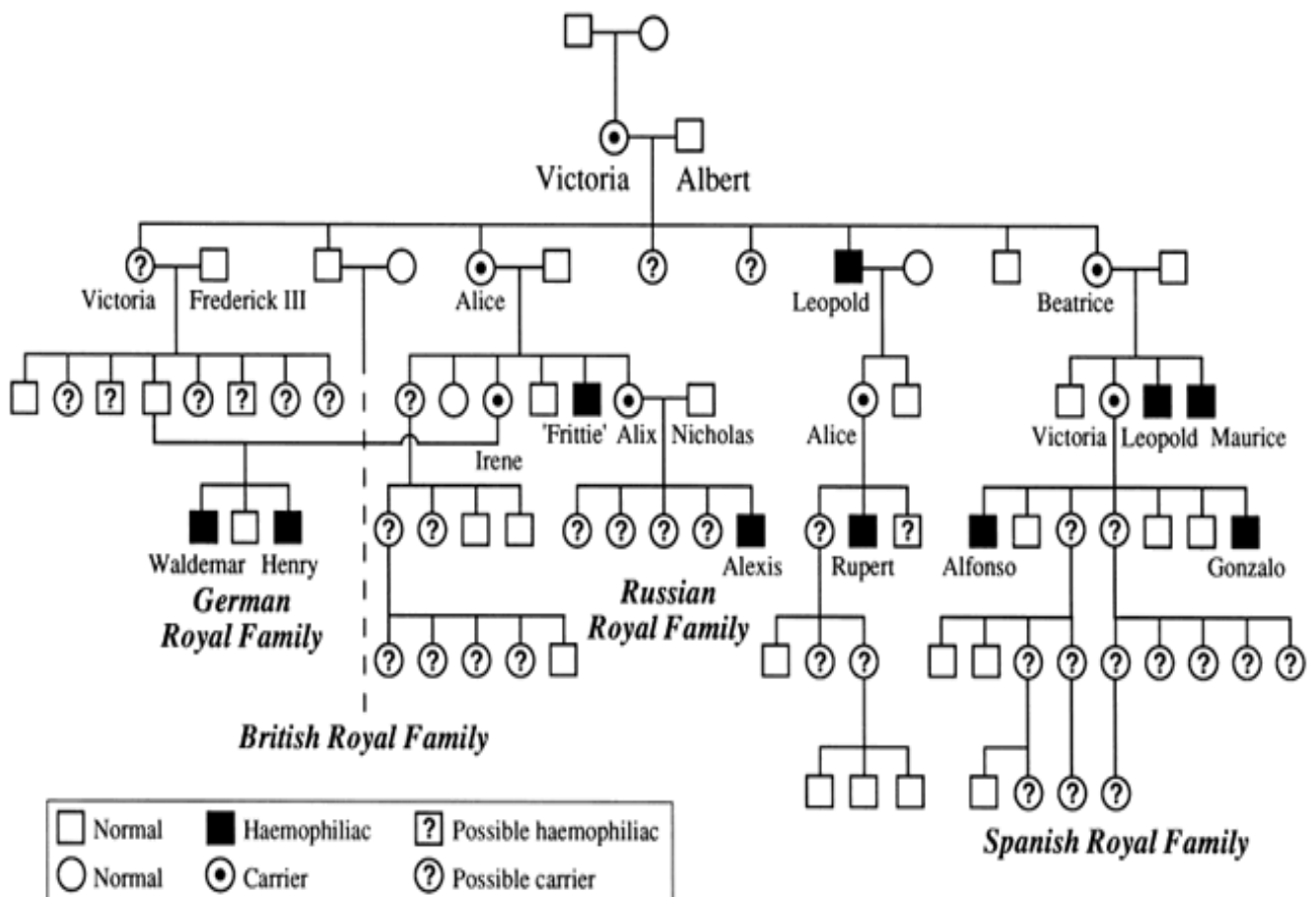

SEX LIMITED AND SEX INFLUENCED CHARACTERISTICS

Sex limited characteristics are the ones which occur particularly in one sex. These characteristics occur at a later stage in the life of an organism e.g. in human beings they normally occur at puberty.

In human beings the males have the following sex limited characteristics beard, deep voice, hairs in the ears and nostrils, porcupine characteristics e.t.c. In human females these characteristics include development of breasts, widening of the hip girdles e.t.c.

Sex influenced characteristics are those whose dominance is determined by the sex of the bearer e.g. baldness of the head occurs in males and not in females because the genes determining it are dominant in males and recessive in females.

VARIATION

This is the description of the differences in phenotypic and sometime genotypic characteristics shown by organisms belonging to the same species or natural population due to interaction between the genes and the environment.

Variations can be clearly seen among sexually reproducing organisms due to some differences in genetic constitution that occur during meiosis.

Variations are important because they make organisms better adapted to their environment. This is because some variations within the population are favorable (beneficial) to the organisms possessing them making such organisms better adapted or fit to survive in their environment and this gives a selective advantage to those organisms possessing them. Other variations are unfavorable because they are disadvantaged in the environment and organisms possessing such. The first organisms therefore survive, grow and reproduce and pass on their favorable characteristics to the next generation. If this continues for a long time it leads to the emergence of new species in the population having good characteristics and therefore better adapted to the environmental change. Variation is therefore a raw material for evolution during which new species are formed.

TYPES OF VARIATION

There are two types of variation namely;

- Continuous variation
- Discontinuous variation

Continuous variation

This is the type of variation whereby characteristics in a given population show a smooth gradation between two offsprings with the intermediate phenotype being the majority in the population and few individuals being at the extremes of the characteristics. This implies that organisms do not show any clear cut differences among themselves.

It is brought about by the influence of many genes but can also be influenced by environmental factors. Continuous variation characteristics are therefore influenced by both environmental conditions and genetic factors.

Examples of continuous variation characteristics include skin color, height, weight, intelligence e.t.c. These characteristics are quantitative i.e. they can be measured and are controlled by many genes. These characteristics are therefore described as **polygenic characteristics** i.e. characteristics which are controlled by

a number of genes during their transmission i.e. many genes control a single characteristic. These genes are sometimes referred to as **multiple genes**. Each dominant allele has a **small quantitative effect** individually on the phenotype and these allelic effects are **additive**. Although these genes may determine a single characteristic each of them has its own alleles which occur on different loci. These genes have an additive effect.

The transmission of characteristics that are controlled by many genes from one generation to another is called **polygenic inheritance** and such characteristics are known as polygenic characteristics. The statistical analysis of these characteristics gives a normal distribution curve shown below;

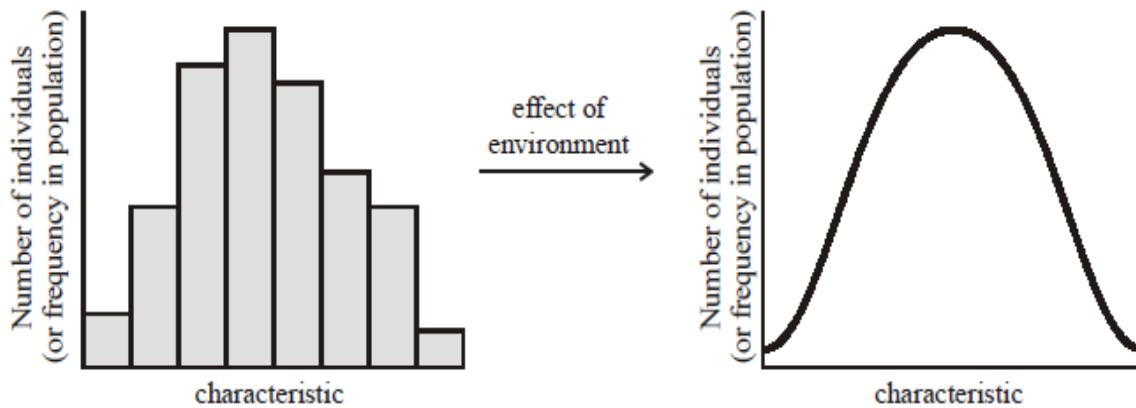

The above graph shows that continuous variation characteristics appear in the graded pattern and therefore show a smooth graduation. It also shows that most of the individuals in the population lie along the normal.

Discontinuous variation

This is the type of variation where individuals show clear cut differences among themselves in the population with no intermediate phenotypes between them but instead they are grouped into distinct categories. These characteristics are therefore qualitative and cannot be measured. Such characteristics include sex, blood groups in man, tongue rolling, e.t.c.

This variation is controlled by a **single gene** and cannot be influenced by environmental conditions i.e. they are purely genetically controlled.

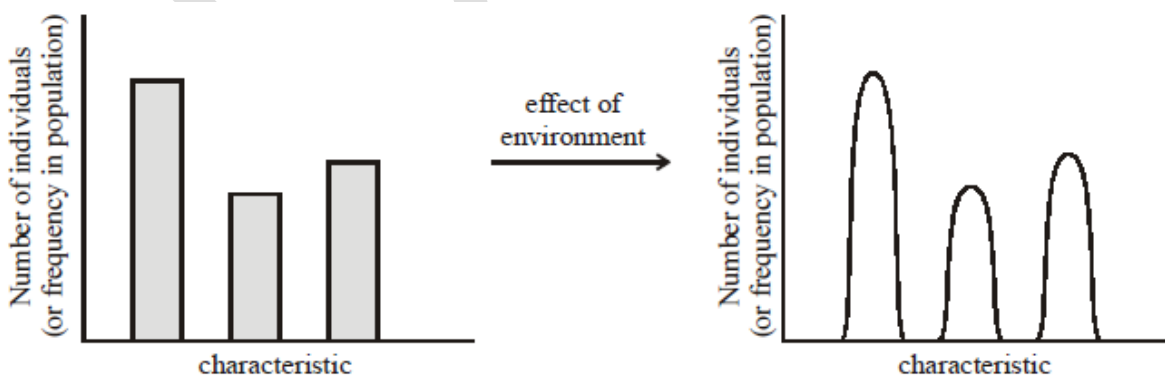

CAUSES OF GENETIC VARIATION

This is caused by the **gene reshuffling** and **mutations**.

Reshuffling of genes refers to the random orientation of chromosomes at the equator of the spindle during meiosis which changes the positions of the genes on the chromosomes.

Reshuffling of genes include the following;

- I. **Crossing over:** this is the exchange of genetic material between the non-sister chromatids of homologous chromosomes during pachytene stage of prophase I of meiosis. This produces new linkage groups and so provides a major source of genetic recombination of alleles on chromosomes which results into formation of recombinant gametes and leads to variation in the offsprings formed. When the gametes undergo random fertilisation, offsprings with different genetic constitution are produced.
- II. **Independent assortment.** During independent assortment in during metaphase 1, chromosomes are distributed randomly at the equator and segregate (separate). It is by pure chance as to which chromosome from each homologous pair ends up in a daughter cell at the end of meiosis and therefore all sorts of allele combinations are possible in the gametes. This reshuffles the existing alleles thereby producing new genetic recombination's in of the gametes and the offsprings formed from these gametes when they fuse randomly during fertilisation.
Independent assortment can therefore be defined as the random orientation of the chromatids of homologous chromosomes (bivalents) on the equator of the spindle during metaphase 1 of meiosis which determines the direction in which the pairs of chromatids move during anaphase 1. This is so because after random arrangement on the equator of the spindle the chromosomes subsequently segregate (separate) independently thereby leading to the mixing of genes in addition during metaphase II the orientation of the pairs of chromatids is again random at the equator of the spindle and determines which chromosomes migrate to the opposite poles of the cell during anaphase II.
- III. **Fertilization.** Fertilization occurs randomly between the male and female leading to mixing of genes in different combinations.
 1. **Mutation.** Mutations change the genotype of an organism with respect to a specific characteristic as it produces new alleles in the population hence making it to vary due to the combination of mutant and non-mutant gametes during random fertilisation.
 2. **Genetic drift.** This refers to a loss of genes from a small population or the change of gene frequency of a small population by chance alone and not natural selection which results into the change of the gene frequency of the small population. This changes the phenotypic appearance of the organisms thereby making them to vary.
 3. **Cross breeding.** This mixes genes from different individuals resulting into the formation of hybrids (heterozygotes) with improved qualities compared to the parents. Cross breeding can be defined as mating of organisms that are pure breeding in which one has better x-tics than another which results into the formation of the hybrid offspring.

MUTATIONS

This refers to the sudden or spontaneous genetic changes which occur in the genetic constitution of an organism. These changes are brought about by mutagens. Mutations change the genotype of an organism with respect to a given characteristic as it produces new alleles in the population. Mutations cause permanent genetic variations unlike reshuffling of genes whose genetic variations are temporary as they can be undone (removed) in subsequent generations due to chromosomes rearranging themselves alongside with their genes.

During mutation, some genetic material may be lost, doubled, inverted, translocated (moved), and mixed, resulting into mutants having different genetic constitution from the non-mutants. The mutants formed transmit these mutated genes to their offsprings through random fertilisation which makes the offsprings become different from the non-mutants.

Individuals or cells resulting from mutations are known as mutants. The sudden changes in the genetic constitution of an organism are brought about by substances called **mutagens**. The common mutagenic

agents include the following;

- | | | |
|----------------------------|---------------------|----------------------------|
| ○ Gamma rays | ○ Chemicals such as | ○ Opium |
| ○ Alpha and beta particles | caffeine and heroin | ○ Cocaine |
| ○ X-rays | ○ DDT and other | ○ Formaldehyde |
| ○ Cosmic rays | insecticides | ○ Some food preservatives, |
| ○ Ultra violet rays | ○ Colchicine | color and sweeteners |
| ○ Excessive heat | ○ Marijuana | ○ Accidents |

Note: mutations usually occur in germ cells during gamete production and so lead to the formation of mutant gametes. When these gametes fuse randomly with mutant or non-mutant gametes of another parent, a mutant offspring is formed which must have unique characteristics compared to the parents. Such mutations are known as **gametic mutations**. Some mutations may occur in somatic cells and are therefore known **somatic mutations** e.g. cancer.

TYPES OF MUTATIONS

There are two types of mutations (germ mutations) namely;

1. Chromosomal mutations
2. Gene mutations (or point mutations)

Somatic mutations cannot be inherited while gametic mutations can be transmitted from parents to the offsprings indeed most of the gene and chromosomal mutations are gametic and can therefore be inherited or they are usually recessive.

Chromosomal mutations

This refers to the changes that occur in the chromosome number or chromosome structure but can be transmitted from the parents to the offspring.

Chromosome mutations usually occur during prophase I of meiosis where a number of mistakes are made on the chromosome structure i.e. chromosomes break and join wrongly. It can also arise during anaphase I and II where by some chromosomes may fail to separate and move to opposite poles which brings about an increase in the number of chromosomes or polyploidy i.e. an increase in the number of chromosomes beyond the normal diploid number. The process by which chromosomes fail to separate during anaphase I of meiosis is known as non-disjunction.

Chromosomal mutations are divided into the following categories;

- a. Mutations that change the chromosome structure.
- b. Mutations that change the chromosome number.

a. Mutations that change the chromosome structure

Such mutations include the following;

i. Deletion

This is a form of mutation where part of a chromosome breaks and gets lost leading to the formation of a number of chromosomes that is shorter than the original chromosome. This is the most dangerous form of mutation because it leads to loss of genes from the chromosome.

In human beings deletion leads to cat cry syndrome where the voice box fails to develop properly

ii. Inversion

This is the form of mutation where part of a chromosome breaks, rotates through 180 degrees and rejoins in the reverse way, this in turn changes the sequence of genes on the chromosomes as well as the sequence of bases on the DNA strand which makes the offspring vary.

iii. Duplication

This is a form of mutation whereby a portion of chromosomes bearing certain gene is doubled. This form of mutation causes over amplification of certain phenotypes whose genes have been duplicated. This form of mutation is of importance in crop and animal husbandry since it increases yields and improves other characteristics.

iv. Translocation

This is a form of mutation whereby a portion of a chromosome breaks and is moved to join another chromosome which may be homologous or non-homologous.

b. Mutations that change the chromosome number

These are mutations that affect the whole chromosome and change the chromosome number in the cell.

This normally occurs during meiosis at anaphase I and II where two of the same type of chromosomes or chromatids fail to separate and are transmitted together into a single gamete leaving the other gamete empty a concept known as **non-disjunction**. The other chromosomes not affected by non-disjunction are usually distributed normally by meiosis into gametes formed.

Non-disjunction results into formation of gametes either with an extra number of chromosomes ($n+1$) ($n+2$) ($n+3$) e.t.c. or a less number of chromosomes ($n-1$). Therefore, this condition where by half of gametes contain extra number of chromosomes while the other half of gametes formed during meiosis contain a chromosome missing is known as **aneuploidy**.

If a chromosome is present in triplicate in the fertilised egg (so that the cell has a total of $2n+1$ chromosomes), the aneuploidy cell formed is said to be **trisomic** and if a chromosome is missing, so that the zygote cell formed has $2n-1$ chromosomes, the aneuploid cell is said to be **monosomic**. Mitosis will subsequently transmit this variation to all embryonic cells (somatic cells) leading to the formation of an organism with variation in the form of a set of symptoms caused by the abnormal dose of genes associated with extra or chromosomes missing.

Some organisms have more than two complete sets of chromosome missing in each of their cells and such organisms are called **polyploids**.

Illustration

Note: The zygote produced with odd number of chromosomes in the above cross containing less than the diploid number of chromosomes usually fails to develop. But those with extra sets of chromosomes though odd numbered or even numbered usually develop and in most cases this produces severe abnormalities. In humans, non-disjunction causes the following abnormalities.

1. Down's syndrome (mongolism)

This disease is also referred to as mongolism and it is caused by an extra autosomal chromosome in position number 21 of the homologous chromosome pairs.

Mongolism occurs as result of non-disjunction in chromosome number or during anaphase I of meiosis in gametes formation leading to formation of abnormal gametes with 24 chromosomes. In such a case if a normal gamete fertilizes an abnormal gamete, the zygote formed will have 47 chromosomes instead of the normal 46. This form of syndrome occurs in both males and females. It can take place during sperm production but it's more common during oogenesis.

Mongolism is due to a type of mutation known as **translocation** in which chromosome 21 is translated or moved to chromosome 14 in most cases or chromosome 22 in some cases.

Most non disjunction occurs in meiosis I where it causes failure of the whole chromosome 21 to separate if it occurs in meiosis II the chromatids fail to separate leading to Down's syndrome.

Mongolism causes miscarriage in mothers and the chances of it to occur increases with age of the females.

This form of syndrome results in individuals having the following characteristics;

- ❖ They are mentally retarded
- ❖ They have a low resistance to infections and therefore have a short life span
- ❖ They have frequent saliva flow from the mouth
- ❖ They have slit eyed appearance.

2. HETEROSOME NON-DISFUNCTION

This is non-disjunction of sex chromosomes which produces a variety of aneuploid conditions which include the following;

a. Klinefelter's syndrome (XXY)

This results from non-disjunction of the sex chromosomes pair in either males or females resulting into a male with 47 chromosomes and genotype XXY. It may occur if a normal Y sperm fertilizes an abnormal egg. It may also occur if an abnormal sperm (XY) fertilizes a normal egg (X). This is illustrated below;

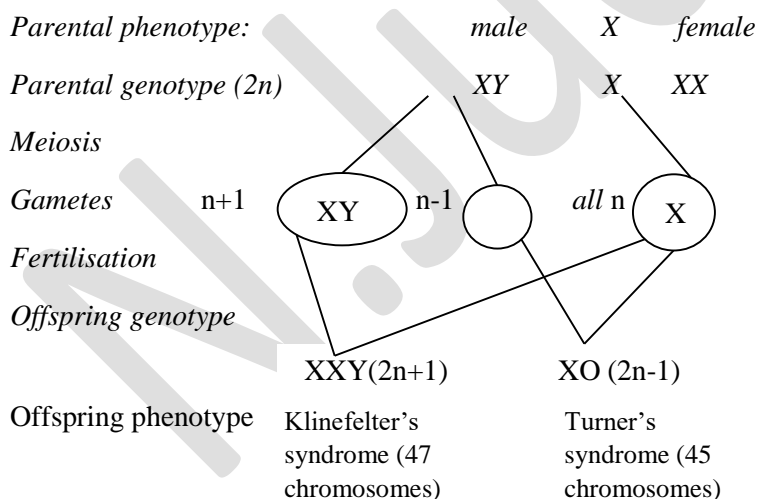

Individuals suffering from Klinefelter's syndrome have the following characteristics;

- ❖ They are infertile (sterile) and therefore they don't produce sperms although erection and ejaculation occurs.
- ❖ Their testes are usually very small compared to the normal males i.e. the testes fail to grow to the expected size.
- ❖ They have very subnormal intelligence
- ❖ They tend to be taller than the average height
- ❖ They have little facial hair

- ❖ They possess some female secondary sexual characteristics e.g. developed breasts and wide hips.
- ❖ Their trunk may show signs of obesity

b. **Turner's syndrome(XO)**

This monosomy condition occurs in females resulting into a female with 45 chromosomes and genotype XO. It occurs as a result of non-dysfunction which results into an abnormal egg or an abnormal sperm. If an abnormal sperm fertilizes a normal egg this condition occurs and if an abnormal egg that is empty is fertilized by a normal sperm containing X chromosomes this condition again occurs. Individuals with Turner's syndrome vary from others by having the following characteristics;

- ❖ They do not show female secondary characteristics such as developed breasts, menstruation, widening of hips e.t.c.
- ❖ They are infertile with no ovaries but with a small uterus.
- ❖ They have a short height than the women average height.
- ❖ They have a webbed neck.
- ❖ They are usually of normal intelligence

c. **Triple X syndrome(XXX)**

This also occurs in females due to non-disjunction which results into formation of an abnormal egg containing XX chromosomes and if such an egg is fertilized with a normal X sperm the triple X female occurs with 47 chromosomes and these individuals have the following characteristics;

- ❖ They are fertile females
- ❖ They are mentally normal
- ❖ They are physically normal
- ❖ They have a very high sex libido

d. **XYY syndrome**

This condition occurs in males with genotype XYY. It occurs in case the Y chromosome undergoes duplication and fails to separate at anaphase I. This may result into production of abnormal sperms containing YY which if they fertilize a normal Xegg and XYY syndrome occurs. Individuals with this syndrome vary from other males by having the following characteristics;

- ❖ They are usually very aggressive and therefore common in prisons and security forces.
- ❖ They are fertile males.
- ❖ They are giants.
- ❖ They are mentally and physically normal

POLYPOIDY (EUPLOIDY)

This is a condition whereby cells of organism possess extra sets of chromosomes beyond the normal diploid number. Polyploidy therefore makes the genetic constitution of an organism multiplied to become $3n$, $4n$, $5n$, $6n$ e.t.c.

Polyploidy is a useful phenomenon in plant breeding where the chromosome number is increased so as to improve on the vigor (characteristic) of the plant i.e. plants acquire better characteristics such as high yields, high resistance to diseases, quick maturity, high resistance to pests e.t.c. It is more common in plants than animals because the increased number of chromosomes in animal polyploidy causes errors in gamete formation unlike in plants which usually reproduce vegetatively without such errors.

Polyploidy brings about genetic variation within a population as it results into the formation of new and different genetic combinations within some individuals of the population. This makes some polyploids within the population better adapted than their original parents and so are favoured by a selection pressure of nature to survive, reproduce and transmit their adaptive variations to their offsprings. However, better adapted polyploids may fail to interbreed with diploid organisms, thereby forming a new species due to possession of extra sets of chromosomes beyond the diploid number.

Polyploidy also results into formation of new species via **interspecific hybridisation**, a process in which the F_1 hybrids formed are sterile because their chromosomes cannot form homologous pairs being that they arise from organisms of different species, but when a diploid number of chromosomes of F_1 hybrids is doubled due to non-disjunction, tetraploids ($4n$) can be formed as F_2 hybrids which can inter breed among themselves to produce fertile offsprings. The F_2 tetraploids formed by interspecific hybridisation can interbreed among themselves to form fertile offsprings but cannot interbreed with any of the original parents because of having extra sets of chromosomes thereby becoming a new species.

The F_2 offsprings formed are described as allopolyploids because they are formed by a type of polyploidy known as halopolyploidy. Halopolyploidy is the one which occurs when two different species interbreed and produce a sterile F_1 hybrid whose chromosome number gets doubled by non-disjunction thereby changing the sterile F_1 hybrids into fertile F_2 hybrids. The halopolyploids formed are fertile with each other but cannot interbreed with a diploid parental species. The F_1 hybrids are sterile because the set of chromosomes from one species cannot pair during meiosis with another set of chromosomes from another species.

Illustration

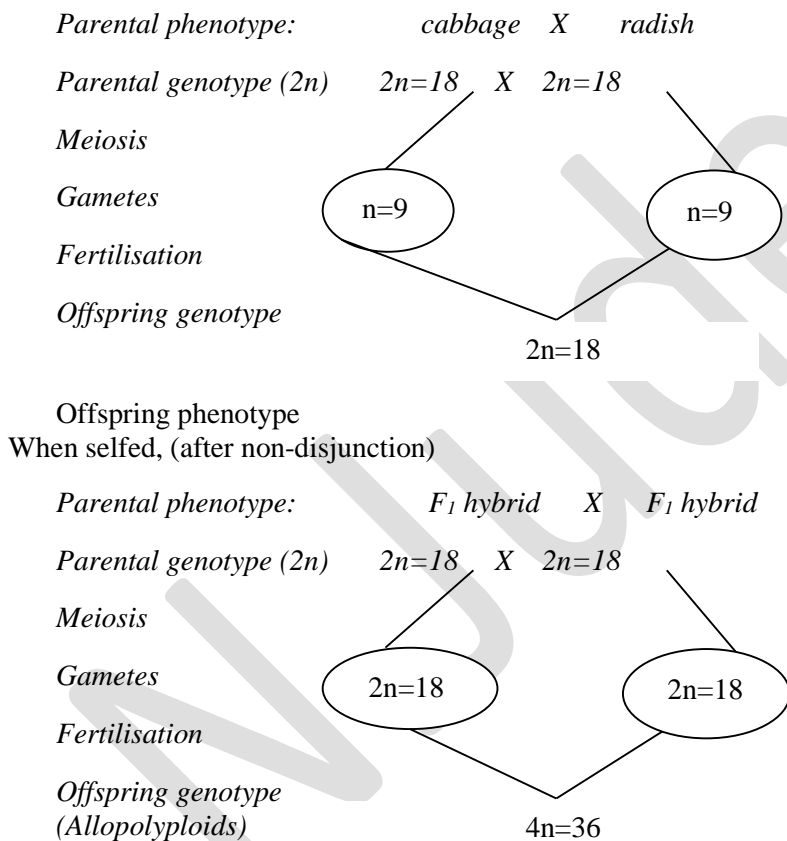

The tetraploids formed is fertile because homologous pairing of chromosomes can occur in meiosis, as the two sets of parental chromosome present in diploid gametes are produced which contain nine chromosomes from the parental cabbage and 9 chromosome of the parental radish.

There are two forms of polyploidy namely; autopolyploidy and allopolyploidy

1. Autopolyploidy

This is where the chromosome number of some individuals in a given species is increased either naturally or artificially by preventing cytokinesis or preventing the formation of spindle fibres during cell division. This can be done artificially using colchicines which prevents formation of spindle fibers thereby increasing the

chromosome number. This mutation prevents the tetraploids from successfully interbreeding with the diploid plants of the original population leading to the reproductive isolation. However, the tetraploids can still produce fertile offsprings by self-pollination or by mating with other tetraploids

Autopolyploid can be as fertile as diploids if they have an even number of chromosomes and they can be infertile if they have odd number of chromosomes because they cannot form homologous pairs.

Colchicines and other related drugs have been used in breeding in certain varieties of tobacco and tomatoes whose cells have a large nucleus.

2. Allopolyploidy

This is a condition which arises when the chromosome number in the sterile hybrids gets doubled and produces fertile hybrids. Sometimes the F_1 offsprings formed may be sterile but if these individuals are crossed with another related

During meiosis in F_1 hybrids chromosomes from each parent cannot pair together to form homologous chromosomes hence the F_1 hybrids produces gametes with a diploid set of chromosomes. This brings about allopolyploid as illustrated below;

The allopolyploid is fertile because homologous pairing of chromosomes can occur in meiosis as the two sets of parental chromosomes are present. Allopolyploid is an example of interspecific hybridization i.e. form of sympatric speciation which occurs when a new species is produced by the crossing of individuals from two unrelated species.

Gene mutations (point mutation)

This is a sudden change in the sequence of nuclear nucleotides or bases of DNA. These mutations are of the following types;

1. **Substitution.** This type of mutation whereby or more bases of nucleotides may be replaced with wrong nucleotides or bases. If we consider the base sequence of GTC, a change to a single base could result in one of the following;
 - **A silent mutation** occurs if the substitution results in a different base occurring in a DNA triplet but one that still codes for the same amino acid. The final polypeptide produced is identical to the original and no effects on the final i.e. Cytosine is replaced by Thymine, GTC becomes GTT.

However, as both these replicates code for glutamine, there's no change to the polypeptide produced.

- **A nonsense mutation** occurs if the base change results in the formation of one of the three stop codons that mark the end of a polypeptide chain e.g if Guanine is substituted with Adenine, GTC becomes ATC. The final protein would certainly be shortened and the protein could not perform its usual function.
 - **A mis-sense mutation** arises when the base change results in a different amino acid being coded for. In the example above, if the final base Cytosine is substituted by guanine, then GTC becomes GTG. The amino acid histidine is coded for by GTG and this then replaces the original amino acid, glutamine. If the original amino acid is vital in the formation of bonds that determine the three-dimensional shape of the final protein then the new protein may not function as the original protein. Sickle cell anaemia is an example of a mis-sense mutation.
2. **Deletion.** This is a form of gene mutation where a section of DNA is lost. This results into wrong transcription and wrong translation processes in protein synthesis. This mutation is dangerous because it leads to absence of certain structures or wrong physiological processes taking place in an organism. Additions or deletions lead to a frame shift in the DNA code, whereby every triplet of bases that follows the change is altered. An example of deletion mutation is cystic fibrosis. This causes very sticky mucus that causes lung congestion, reduced gaseous exchange and blocked pancreatic ducts.
 3. **Insertion.** This is where one or more nucleotides may be fixed in a particular DNA strand. This also causes a frame shift. Every single triplet genetic code after the mutation point is altered. This results in either a different DNA strand synthesised during semi-conservative replication or an altered mRNA with many different codons is produced during transcription. This leads to formation of an incorrect series of amino acids in the polypeptide chain. Frame shift mutations cause severe effects on the phenotype and are sometimes lethal to the organisms.
 4. **Inversion.** This is where a group of nucleotides in DNA becomes reversed after rotating through 180 degrees. Non-frame shift mutations does not cause the alteration of the whole nucleotide base sequence (reading frame). Only the mutated single code in DNA and a single codon in mRNA are affected. Therefore only one amino acid is different in the resultant polypeptide that is synthesised. If the different amino acid is located within the active site of an enzyme or involved in the folding of a particular protein, this would affect the functioning of the enzyme or enzyme. Substitution and inversion are two types of non-frame shift mutations.

OUT OF CLASS EXERCISES

1. (a) State **Mendel's law of dihybrid inheritance.** (01 mark)
- (b) In garden peas, a cross between plants with yellow-round seeds and those with green-wrinkled seeds produces all offspring being with yellow-round seeds.
 - (i) Suggest an explanation about the inheritance of seed colour and seed shape in peas. (02 marks)
 - (ii) State the genotypes of the parental and **F1** offspring all with yellow-round seeds? (Use suitable symbols) (02 marks)
- (c) Work out the **F2** phenotypic ratio if the **F1** plants are self-pollinated (05 marks)
2. A man and a woman who are both normal for blood clotting have a haemophilic son. Haemophilia is a sex-linked recessive disorder.
 - (a) What is meant by sex-linked gene?
 - (b) Draw a single pedigree diagram to show the genotypes of the three individuals. Explain how the pedigree is obtained.
 - (c) What is the probability that their second child would be
 - (i) a boy suffering from haemophilia?

- (ii) a daughter who is a carrier?
- (d) (i) Could a woman be a haemophiliac? Give reasons for your answer.
 (ii) Explain why a human population will contain more colour-blind individuals than haemophiliacs

3. (a) Describe how DNA replicates semi conservatively (10 marks)
 (b) Describe the experiments carried out by Meselson and Stahl to demonstrate that replication of DNA is semi conservative. (10 marks)

4. (a) In snapdragon flower colour is determined by two alleles of **R** for red and **W** for white which are incompletely dominant.
 A population has the following individuals distributed as shown in table 3 below

Flower colour	Number of individuals
Red	450
Pink	500
White	50

- (b) Using the information provided determine the
- (i) total number of the **R** and **W** alleles in the population. (03 marks)
 (ii) Genotype frequency for each genotype. (03 marks)
 (iii) Allele frequencies of each allele. (02 marks)
- (c) State **two** causes of change in the allele frequencies and genotype frequencies in population. (02 marks)
5. (a) What do you understand by the following terms?
 i) **Allele** (01 mark)
 ii) **Co-dominance** (01 mark)
- b) In cats the allelic gene for black colour and ginger colour shows co-dominance. This gene is sex-linked. A male cat with ginger coat colour was crossed with a female with black coat colour. Using genetic symbols work out the genotypes of across of the **F₁** off springs. (08 marks)
6. In cats, short hair is dominant over long hair, the gene involved is autosomal. Another gene which is sex-linked produces yellow coat colour, its allele produces black coat colour and the heterozygous combination produces tortoise shell coat colour.
- a) If long haired black male is mated with a tortoise shelled female homozygous for short hair, what kind of offspring will be produced in **F₁**. (08 marks)
- b) i) If the **F₁** cats are allowed to interbreed freely among themselves what are the chances of obtaining long haired female.
 ii) Apart from being sex linked what else can you say about the inheritance of the gene for coat colour.
7. Chickens with shortened wings and legs are called **creepers**
- (i) When creepers are mated to normal birds, the offspring ratio is creepers: normal birds are in equal frequency.
 (ii) When creepers are mated to creepers the offspring ratio is **two** creepers: **one** normal
 (iii) Crosses between normal birds produce only normal progeny.
- (a) Explain these results using your knowledge of genetics (4 marks)
 (b) Using suitable symbols work out the genotype and phenotypes of the offspring of the second cross. (5)
 (c) State the genotypes of the parents in the third cross (1 mark)

8. In humans, the inheritance of skin pigmentation is controlled by two genes **a** and **B**, such that the presence of both genes in the genotype results in black pigmented skin. Presence of gene **A** in absence of **B** results in dark brown pigmented skin and absence of gene **A** when **B** is present results in light brown pigmented skin. Absence of both genes results in white skin (albino).
- What does the above information indicate about the inheritance of skin pigmentation in humans? (02 marks)
 - Determine the phenotypic ratio of a cross between a black man and a dark brown woman that results in offspring of all skin colours with light brown and white skins being fewer but equal proportions and black and dark brown being more but also in equal proportions. (07 marks)

9. The genetic code contains punctuation codons to mark the start and end of synthesis of polypeptide chains on ribosomes
- State the codes for;
 - Start codon (01 mark)
 - Stop codon (01 mark)
 - Outline the process of the formation of mRNA from DNA (03 marks)
 - State **two** structural differences between mRNA and DNA (02 marks)
 - Explain the role of mRNA in protein synthesis (02 marks)
 - What is the fate of the proteins made in a cell? (01 mark)

10. (a) state where each of the following is found in a cell (01 marks)
- DNA
 - RNA

- (b) Give three structural differences between DNA and RNA (03 marks)

DNA	RNA

- (c) What is the genetic significance of DNA replication? (03 marks)
- (d) Give two evidence that suggest DNA as a hereditary material (02 marks)

11. (a) State **two** situations where Mendel's laws would **not** apply (02 marks)
- b) In an animal species, individuals that are homozygous for gene **A** or its alleles die. Another independent gene **B** in the homozygous state, blocks this lethal effect, otherwise gene **B** has no other effect on the organism.
- Workout the expected phenotypic ratio of the viable offspring in a cross of individuals **AaBb** and **AaBB** genotypes (05 marks)
 - State the type of gene interaction in b (i) (01 mark)
- c) Explain why a rhesus negative mother of blood group O is carrying a rhesus positive child of any blood other than O, haemolytic disease of the newborn does not arise (02 marks)

12. A cross between two fruit flies with long wings and red eyes yields in the progeny mutant phenotypes called curved wings and lozenge eyes as follows

Females	Males
600 long wing red eyes	300 long wings red eyes
200 curved wings red eyes	100 curved wings red eyes
	300 long wings red lozenge eyes
	100 red wings lozenge eyes

- (a) Suggest what type of allele causes (02 marks)
- Curved wings
 - Lozenge eyes

(b) Using suitable symbols state the genotypes of the parents (03 marks)

(c) Work out the genotypes of the offspring of this cross (05 marks)

13. (a) The figure below shows the number of bases found in the sense strand and the antisense strand of a short piece of DNA, and the mRNA transcribed from it

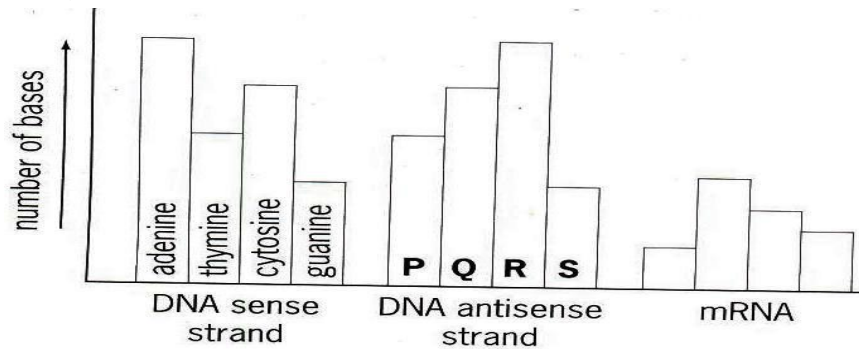

- Identify the bases represented by each of the following letters **P, Q, R** and **S** (02 marks)
 - Explain why the total number of bases in the DNA sense strand and the total number of bases in the DNA antisense strand are the same (02 marks)
 - Explain why the total number of bases in the DNA sense strand and the total number of bases in the mRNA strand are different (02 marks)
- (b) The mRNA has a sequence of 1824 bases. How many amino acids will join to form the polypeptide chain? (03 marks)
- (c) Although DNA is double stranded only the sense strand determines the specific amino acid sequence of a polypeptide chain. Suggest one role of the antisense strand (02 marks)

14. (a). What is meant by the term **Co-dominance**. (02 marks)

(b). In mice, coat colour is determined by alleles **A** for agouti (black) and **a** for brown. Another allele **C**, at another locus, however, determines the expression of colour and its recessive allele **c** lack of it i.e. albino. Show the phenotypic ratio of the **F₂**offsprings of a cross between two homozygous brown and agouti mice (08 marks)

- (d) The following is an account of tongue rolling (due to a dominant autosomal gene **T**) in a family. A man has both of his parents unable to roll their tongues and a wife who can roll her tongue and so is her grandparents and mother but whose father and sister cannot. They produce a son who can roll his tongue, marries a wife who can roll her tongue too and they produce five children two of these are sons and neither can roll their tongues and three daughters two of whom can roll and the other cannot. Express the transmission of tongue-rolling in this family through the generations in the form of a pedigree. (04 marks)

15. a) What is meant by the term **linkage**? (02 marks)

In one species of tomato, the stems can be of different colours (green or purple) and may be hairy or hairless. In an experiment, a homozygous tomato plant with green and hairless stem was crossed with another plant homozygous for purple and hairy stem. The resulting **F₁** plants had purple and hairy stems. By using symbols **A** for dominant allele for colour and **a** for recessive allele for colour, and **B** for dominant allele for hairlines and **b** for recessive allele for hairiness

b) State the genotypes of each parent and **F₁** offspring (03 marks)

c) When **F₁** plants were selfed, the phenotypes and number of offspring is given in the table below.

Phenotypes	Number of offspring
Purple, hairy	293
Purple, hairless	15
Green, hairy	12
Green, hairless	98

- i) In this dihybrid cross what would be the expected ratio of phenotypes in the offspring? (01 marks)
- ii) Explain the difference between the expected ratio and the numbers shown in the table (02 marks)
- iii) Calculate the crossover value and explain how it may affect the numbers of plants having phenotypes purple-hairless and green-hairy (03 marks)
- d) If a tomato breeder wanted to find out which of the purple, hairy plants and homozygous for both characters
- i) State the genotype of the plant which should be crossed with the purple, hairy plants in the test cross (01 marks)
- ii) Explain why this genotype should be used (01 marks)
16. In guinea pigs, the gene that controls the production of enzyme tyrosinase to synthesise melanin is epistatic to the gene at another locus that regulates deposition of melanin. Deposition of melanin in the hair produces a coat colour and is regulated by the gene with allelic pair **B** and **b**. **B** represents the dominant allele for black coat and **b** the recessive allele for brown coat. Another gene (alleles **A** and **a**) located on a different locus, control the production of melanin. The alleles **A** codes for enzyme tyrosinase which converts a colourless precursor to melanin. The recessive allele **a** codes for an inactive form of the enzyme.
- a) What is meant by the term **epistasis**? (02 marks)
- b) Describe what happens if the animal is homozygous recessive **aa**? (02 marks)
- c) If a cross is carried out between a male guinea pig with genotype **AaBb** and a female guinea pig with **Aabb**, what is the possible phenotypic ratio of the F_1 generation? Use a genetic diagram to show the results of the above cross. (06 marks)
17. (a) A biochemical analysis of a sample of DNA showed that 33% of the nitrogenous bases were guanine. Calculate the percentage of the bases in the sample which would be adenine. Explain how you arrived at your answer? (06 marks)
- (b) (i) What name is given to the triplet of bases which designate an individual amino acid.
- (ii) If the triplet of mRNA which designates amino acid lysine is AAG (Where **A**= adenine and **G** = guanine), what is the complementary triplet of three bases on the tRNA molecule? Give a key for the letters that you use. (03 marks)
18. (a) Phenylketonuria (PKU) is an inherited disease caused by a recessive allele. If a woman and her husband who are both carriers have three children, what is the probability of having the following?
- i. All three children being normal (01 mark)
- ii. One or more of the three children having the disease (01 mark)
- iii. All three children having the disease (01 mark)
- iv. At least one child being normal (01 mark)
- (b) In some pea plants a true breeding red flowered strain with terminal flowers gives all pink flowers. Flowers can be positioned terminally or in the axis irrespective of flower colour. Work out the F_2 phenotypic ratio resulting from a cross involving true breeding axial red and terminal white parents (06 marks)
19. (a) What is meant by the term **mitosis**? (02 marks)

Figure 5 shows four animal cells in different stages of the mitotic cell cycle.

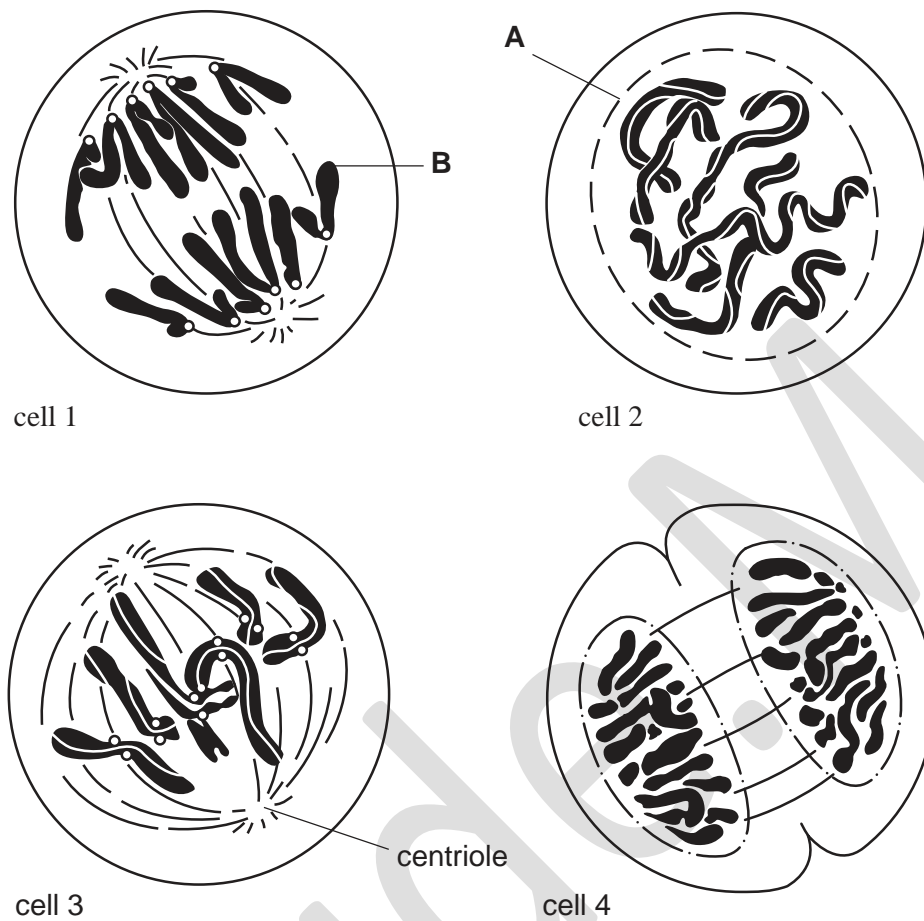

(b) Using the number given to each cell in Fig. 5, arrange the stages as they occur in the mitotic cell cycle. (01

(c) (i) State what is occurring at **A** in cell 2. (01 marks)

(ii) Label **B** is pointing to a region of the chromatid that contains repetitive nucleotide sequences. State the name given to this region. (01 marks)

(d) The centriole labelled in Fig. 5 is composed of microtubules.

(i) Suggest why a student would **not** be able to see a microtubule using a good quality light microscope. (02 marks)

(ii) Outline the role of microtubules in mitosis. (02 marks)

(e) What is the significance of mitosis to eukaryotic cells (01 marks)

20. (a) What is meant by the term **linkage**? (02 marks)

(b) In man the gene for red blood corpuscle shape is represented by alleles **E** (elliptical) and **e** (normal), while another gene for rhesus blood is represented by alleles **R** for rhesus positive and **r** for rhesus negative. The two genes are linked. A person may have alleles **E** and **R** on one chromosome and **e** and **r** on its homologous partner.

(i) State possible genotypes of the gamete if

- there's crossing over (02 marks)
 there's no crossing over (01 marks)
- (ii) If a man with genotype **EeRr** marries a woman with genotype **eerr**, what is the chance that this couple will produce a child with the genotype **Eerr** if linkage is complete? (Show your working) (04 marks)
- (c) Give **one** disadvantage of linkage. (01 mark)
21. A farmer crossed sweat pea plants with purple flowers and long pollen grains with those red flowers and round pollen grains. The **F₁** plants had purple flowers and long pollen grains. However in **F₂** the off springs were:
- 4891 purple, long plants
 390 purple, round plants
 393 red, long plants
 1338 red, round plants.
- (a) (i) Determine the phenotypic ratio of the **F₂** off springs. (½ marks)
 (ii) What theoretical phenotypic ratio would you have expected among the **F₂** off springs? (½ marks)
 (iii) What explanation can you give to the farmer for the experimental results obtained. (2 marks)
- (b) (i) By means of a genetic diagram explain how the results in **F₂** were obtained. (6 marks)
 (ii) Determine the cross over value for flower colour and pollen shape characteristics. (2 marks)
22. In tomatoes the allele for red fruit **R** is dominant to that for yellow fruit **r**. The allele for tall plant **T** is dominant to that for short plant **t**. The genes assort independent of each other during their transmission.
- (a) A tomato plant is homozygous for allele **R**. Giving a reason for your answer in each case, how many copies of this allele would be found in:
- (i) a male gamete produced by this plant? (02 marks)
 (ii) a leaf cell from this plant? (03 marks)
- (b) A cross was made between two tomato plants.
- (i) The possible gametes of the plant chosen as the male parent were **Rt, Rt, rT** and **rt**. What was the genotype of this plant? (½ mark)
 (ii) The possible gametes of the plant chosen as the female were **rt** and **rT**. What was the phenotype of this plant? (½ mark)
 (iii) What proportion of the off spring of this cross would you expect to have red fruit? Use a genetic cross to explain your answer. (05 marks)
23. In *Drosophila*, the gene for wing length and shape of the abdomen are sex linked. The genes for long wing and broad abdomen are dominant over those for vestigial wings and narrow abdomen
- (a) Work out the phenotypes resulting from a cross between a vestigial winged and a broad abdomen male and a homozygous long winged and narrow abdomen female fly in the
- (i) **F₁** generation (06 marks)
 (ii) **F₂** generation (04 marks)
- (b) A cross between a female from the **F₁** generation in (a) (i) with a vestigial winged and narrow abdomen male fly gave the following results;
- Long winged, narrow abdomen flies = 35
 Long winged, broad abdomen flies = 17
 Vestigial winged, narrow abdomen flies = 36
 Vestigial winged, broad abdomen flies = 18
- Account for the phenotypes and their relative numbers in the cross (05 marks)
- (c) Explain why *Drosophila* are commonly used in genetic experiments (05 marks)

24. (a) How is sex determined in humans? (04 marks)
 (b) A woman has four sons, one of whom is a haemophiliac and the other three are normal.
 i. What are the possible genotypes of the woman and her husband? (12 marks)
 ii. Is it possible for the couple to have a haemophiliac daughter? Explain your answer (04 marks)

25. The following experiments were performed using the fruit fly *Drosophila melanogaster*.

Experiment 1

Male flies showing two recessive sex linked characteristics: white eyes and vestigial wings were mated with females which were true breeding for wild type eyes and wild type wings.

The female offsprings of this first cross were then mated with their parents. The results of this second cross had 72 flies with white eyes, vestigial wings, 80 flies with white eyes, wild type wings, 76 flies with wild type eyes, vestigial wings and 84 flies with wild type eyes, wild type wings

Experiment 2

Male flies showing two recessive sex linked characteristics: white eyes and vestigial wings were mated with females which were true breeding for wild type eyes and wild type wings.

The female offsprings of this first cross were then mated with their parents. The results of this second cross had 128 flies with white eyes, vestigial wings, 21 flies with white eyes, wild type wings, 17 flies with wild type eyes, vestigial wings and 136 flies with wild type eyes, wild type wings.

- a) i) Using suitable symbols, explain the crosses responsible results obtained in Experiment 1 .
 ii) What is the cross over value?
 iii) What are the positions of the alleles of white eyes and vestigial wings on the Drosophila chromosome in Experiment 1?
 b) i) Why are the results observed in the second cross of Experiment 2 different from those observed in a similar cross in Experiment 1?
 ii) What are the positions of the alleles of white eyes and vestigial wings on the Drosophila chromosome in Experiment 2 ?
 c) Briefly comment on the significance of these results in relation to Mendel’s law of Independent Assortment.

26. (a) Give any

i) Two similarities between DNA and RNA molecules.

Similarities:-

ii) Three structural differences between DNA and RNA MOLECULES

DNA	RNA
1.	
2.	
3	

b) The diagram shows the sequence of bases on one strand of a short length of DNA

ACC CGACCC CAG

This sequence should read from left to right

- i) Give the base sequence that will be produced as a result of transcription of the complete length of DNA shown in the diagram.
- ii) Give the bases of the transfer RNA which will correspond to the sequence of bases shown in the box on the diagram.
- c) Of what importance are the following during protein synthesis?
 - i) Nonsense triplets.
 - ii) Ribosomes.
 - iii) ATPase enzyme.

27. (a) Distinguish between sex-linked and sex-limited characteristics, giving one example in each case. (02 marks)
- (b) In *Drosophila melanogaster* the inheritance of eye colour is sex-linked. The gene for red eye is dominant to that for white eye. A cross was made between a white eyed female and red eyed male, what are the phenotypes and genotypes of the F1? (Show your working) (04 marks)
- (c) What are the phenotypes and genotypes when a reciprocal cross is carried out? (show your working) (02 marks)
- (d) Give two characteristics of sex-linked characters. (02 marks)
28. What is a sex linked trait?
- b) Name any three sex linked traits.
 - c) Coat colour in cattle is inherited by Co-dominance. A red bull was mated with a white cow. Two of the produced were then crossed to get better varieties. Using well define genetic symbols, carry out diagrammatic crosses and then give the genotypic phenotypic ratios of Calves in the second filial generation.
29. (a) Mention any two reasons why Mendel chose to use *Pisum sativum*, in his experiments.
- (b) Manx cats do not have tails. When a manx cat is mated with a normal long tailed cat, approximately half of the offsprings are long tailed and approximately half are manx. When two Manx are mated, the ratio of offsprings is 2 Manx to 1 long tailed cat.
- (i) What does this suggest about the inheritance of the Manx condition in cats
 - (ii) Show by means of a cross, the inheritance of the Manx condition when two Manx cats are mated.

30. In mice fur colour is controlled by a gene with multiple alleles as shown below;

Black & tan = C^{bt} yellow = C^y
 Agouti = C^a black = C^b

- (a) Explain the following crosses
 - i. Mice with agouti fur crossed with mice with black fur produce all agouti offspring or some agouti and some black. (03 marks)

- ii. Heterozygous parents with genotype $C^y C^b$ produce a ratio of two yellow mice to one black mouse. (03 marks)
- (b)(i) What is a test cross? (01 marks)
- (ii) Describe how you would carry out a test cross to determine the genotype of a black and tan mouse. (03 marks)

31. A single dominant gene **I** blocks the action of gene **C** for colour formation at another locus in some species of chicken such that presence of gene **C** results in coloured feathers in the absence of gene **I**. The recessive alleles have no effect on colour. When white Plymouth rock and white leghorn chickens are crossed the F₁ offspring are all white as expected but the F₂ have both white and coloured birds in the ratio 13 white: 3 coloured.

- a) Explain why
- i) Leghorns are white (03 marks)
- ii) Plymouth rock are white (02 marks)
- iii) F₁ offspring are all white (01 mark)
- iv) Some F₂ offspring are coloured (03 marks)
- b) of the F₂ offspring how many are plymouth rock (01 mark)

32. Two genes **A** and **B** located on different chromosomes interact to determine three coat colours in mice. i.e. Grey, Black and Chocolate. Each gene has a recessive allele.

The table below shows the phenotypes and genotypes of some of the mice

Genotype	Phenotype
AABb	Grey
Aabb	Grey
aaBb	Black
Aabb	Chocolate

- (a) State the expected coat colour of the genotypes given below (02 marks)

Genotype	Expected coat colour
AA BB	
AAbb	
AaBb	
aaBB	

- (b) Work out the genotypic and phenotypic ratios of the F₂ offspring of a pure breeding Grey and Chocolate mice. (08 marks)

33. (a) Biochemical analysis of a sample of DNA showed that 33% of the nitrogenous bases were guanine. Calculate the percentage of bases in the sample which could be adenine. Explain how you arrived at the answer. (03 marks)

- (b) (i) What name is given to the triplet of bases which designate an individual amino acid? ($\frac{1}{2}$ marks)
- (ii) State three properties of the feature given in (b)(i) above. ($1\frac{1}{2}$ marks)

(c) The following table gives the amount of DNA in a cell at various stages of cell division. The least amount of DNA present at any stage is taken as 1.0 and this is used as a basis for comparison of other stages.

DNA content of the cell	Stage of cell division
1.0	(Meiosis) late telophase II
2.0	(Mitosis) early interphase, late telophase. (Meiosis) metaphase II
3.0	(Mitosis) prophase (Meiosis) anaphase I

Explain the differences in DNA content between:

- i. Mitosis early interphase and mitosis prophase (02 marks)
- ii. Meiosis anaphase I and meiosis metaphase II (02 marks)
- iii. Meiosis metaphase II and meiosis late telophase (01 mark)

34. A pure breeding tall tomato plant with green leaves was crossed with a pure breeding dwarf plant with mottled yellow and green leaves. -All the **F1** were tall and had green leaves.

- a) Using genetic symbols ^show the results of the test cross of the F1 offspring
- b) The actual results of the test cross gave the following off springs
 - A. Tall with green leaves - 43
 - B. Tall with mottled leaves - 07
 - C. Dwarf with green leaves - 05
 - D. Dwarf with mottled leaves- 45

Explain the difference in the results of the two crosses

(c) State three harmful genetic effects of inbreeding.

35. In domestic poultry the character of the comb is controlled by two genes **R** for **rose comb** and **P** for **pea comb**. If the dominant allele **R** is present in the genotype with a dominant **P** then a **walnut comb** is produced. If an individual is homozygous recessive for both alleles a **single comb** is produced. If an **R** is present without a **P** in the genotype the comb is rose whereas a **P** without an **R** produces a pea comb.

- (a) Determine the phenotypic ratio among the offspring of a cross between two birds whose genotypes are **RrPp X Rrpp** (06 marks)
- (b) A walnut crossed with a single produced among the progeny only one single combed offspring. What were the possible genotypes of the parents? Show your reasoning (03 marks)
- (c) Suggest a cross between two birds of different comb shapes that produce offspring among which all four combs are represented in equal proportions (01 mark)

36. (a) In an oil seed plant species, the allele for tallness is dominant over that for dwarfness. Meanwhile the allele for chlorophyll production and non-chlorophyll show incomplete dominance. The heterozygous plants are variegated.

- (i) Using suitable symbols, construct a diagram of a cross between a tall plant with green leaves and a dwarf plant with variegated leaves, to show the genotypes and phenotypes of the offspring. (05 marks)
- (ii) Explain why 25% of the offspring of the cross in (a) would fail to survive (02 marks)

37. A cross was carried out between two maize plants, one true breeding for brown pericarp and shrunken endosperm, the other true breeding for white pericarp and full endosperm. The resulting **F1** plants, all white pericarp and full endosperm, were backcrossed against double recessive plants.

The **F2** results were;

- 81 white pericarp, full endosperm
- 89 brown pericarp, shrunken endosperm
- 14 white pericarp, shrunken endosperm
- 16 brown pericarp, full endosperm

- a) Present the information given in a diagrammatic form (05 marks)
(Symbols, **W**-white pericarp, **F**-full endosperm)
- b) State which members of the **F2** generation are recombinants (02 marks)
- c) Calculate the percentage number of recombinants present in **F2** generation (02 marks)
- d) How many units apart on the chromosomes are the genes that determine pericarp colour and endosperm type? (01 mark)

38. a) Explain the following terms

- (i) Recessive allele (01mark)
- (ii) Co dominant allele (01 mark)

b) The figure below shows inheritance of the Rhesus blood group in one family

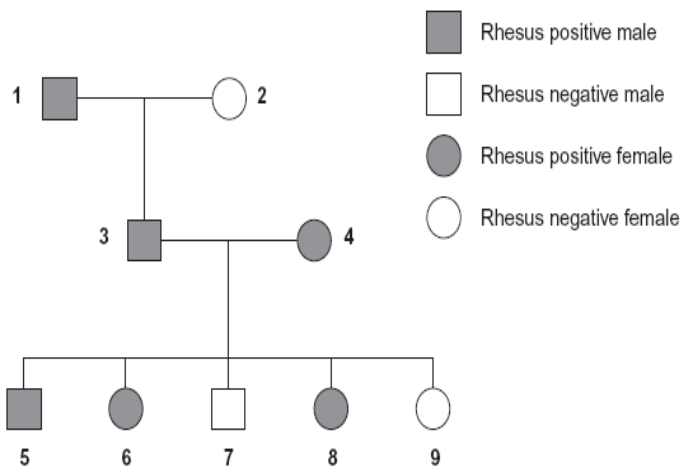

Explain one piece of evidence from the diagram which shows that:

- (i) the allele for Rhesus positive is dominant (02 marks)
- (ii) The gene is not on the X chromosome (02 marks)
- c) Sixteen percent of the population of Europe is Rhesus negative .What percentage of individual would you expect to be heterozygotes for Rhesus gene? (04 marks)

39. Wild rats are grey coloured while albinos rats are white in colour. The results below are for breeding experiments involving the two species of rats

- I. Mating albino rats with wild rats produced equal proportions of wild and albino rats

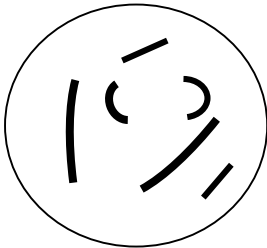
- II. Mating wild offsprings from I produced litter of wild and albino rats in the ratio of 2:1 respectively
- III. Mating albino rats produced only litter of albino rats
- a) Using suitable symbols, work out the mating in I showing the phenotypic and genotypic proportions of the off springs (04 marks)
- b) From your answer in (a) above explain;
- How colour in rats is controlled (01 mark)
 - The results for the matings I-III above (03 marks)
- c) Give two **ecological significance** of colour in organisms (02 marks)
40. (a) What are sex limited characters? (02 marks)
- b) Explain why sex linked characters are more common in males than females (03 mark)
- c) Although the frequency of the gene for abnormal haemoglobins in human population is low, that gene cannot completely disappear from the population. Explain that observation (03 marks)
- d) What is meant by a pure line? (02 marks)
41. The diagram below shows the nucleus of an animal cell
- 
- (a) Name the structures seen inside the nucleus. (01 mark)
- (b) Draw the correct number and types of these structures as they would appear;
- After mitosis
 - After meiosis ,of the nucleus
- (c) What's meant by;
- F1 hybrids
 - Breeding true
- (d) Explain why F1 hybrids will not breed true if they are self-fertilized. (04 marks)
42. (a) Describe the following genetic abnormalities.
- Mongolism (04 marks)
 - Klinefelter's syndrome. (04 marks)
- (b) Explain the formation of new species, from organisms of two different species. (12 marks)
43. (a) State and explain the law of segregation of Mendel.
- (b) Explain how the following are determined in man.
- Sickle cell anemia
 - sex
44. (a) Distinguish between continuous and discontinuous variation. (05 marks)
- (b) In oats, the grain is enclosed by the dried remains of the outer parts of the flower called the hull. In a cross between two pure breeding varieties of oats, one with black hulled grains and the other with white hulled grains, the F₁ off spring all had black hulled grains. Allowing the F₁ plants to self fertilize gave an F₂ with the phenotypes shown below.

Phenotype	
Black hulled grains	418
Grey hulled grains	106
White hulled grains	36

The data shows evidence of epistasis

- (i) What is meant by the term epistasis? (01 mark)
- (ii) How does epistasis differ from mendalian dominance? (04 marks)
- (iii) What genetic ratio is suggested from the figures given? (01 mark)
- (iv) Set out the crosses to show the gametes, genotypes and phenotypes in each generation. State the phenotypic ratio obtained. (09 marks)
45. (a) How does meiosis explain Mendel's first law of inheritance? (04 marks)
- (b) (i) What is meant by the term genetic drift? (02 marks)
- (ii) Describe how genetic drift affects the amount of genetic variation within very small populations.
- (c) Explain the cause of genetic variation. (10 marks)
46. (a) Describe the structure of the tRNA molecule
- (b) How does the body make insulin hormone?
47. (a) Describe the contribution of meiosis towards variation (10 marks)
- (b) Compare mitotic prophase and prophase I of meiosis (10 marks)
48. (a) Describe the process of semi conservative DNA replication (06 marks)
- (b) State the difference between continuous variation and discontinuous variation (06 marks)
- (c) Describe the role of DNA in controlling polypeptide chain synthesis (10 marks)
- (d) Explain the relationship between the Watson–Crick DNA structure and its function (10 marks)
49. a) Describe how you would carry out and record the results of a dihybrid cross to obtain F_1 and F_2 generations in a named organism emphasizing reasons for the procedures (07 marks)
- b) Consider an F_1 generation of a dihybrid cross. Explain how the results of F_2 are dependent on the behaviour of chromosomes during meiosis in F_1 . To what extent can the genotype interact with the environment to give phenotypes? (08 marks)
- c) A typical 9:3:3:1 phenotype ratio is obtained in F_2 of a dihybrid cross. What effect do the following have on the ratio;
- Linkage
 - Incomplete dominance
- Explain your answer (05 mark)
50. (a). How does meiosis explain **Mendel's law of inheritance**? [06 marks]
- (b). Describe how abnormal haemoglobin arises in the human population [09 marks]
- (c). Explain the effects of the gene for abnormal haemoglobin in the human population. [05 marks]
51. (a). Distinguish between continuous and discontinuous variation in a species. [05 marks]
- (b). Hoe does epistasis differ from Mendelian dominance? [04 marks]
- (c). Account for the existence of **genetic variation** in a population [11 marks]
52. (a). Explain how sex is determined in mammals. [05 marks]
- (b). Describe how mongolism a rises in the human population. [08 marks]

(c). Explain interspecific hybridization.

[07 marks]

53. (a) Explain the meaning of each of the following terms with examples:

- | | |
|----------------------|-------------------------|
| i. Test cross | iv. Pure breeding line |
| ii. Reciprocal cross | v. Sex-linked traits |
| iii. Pedigree | vi. Sex limited traits. |

(b) A daughter of a couple where the woman was a carrier for red-green colour blindness and the husband had red-green colour-blindness got married to a man with normal colour vision.

- (i) What are the possible genotypes and phenotypes of the grand children of the original couple?
 (ii) What is the probability that any of the grand children will be colour-blind?

54. a). Describe the mechanism of semi conservative replication.

[09 marks]

b) Describe the formation of polypeptide chains in the cytoplasm of the cell.

[11 marks]

55. (a) What is the genetic basis of

- (i) hybrid vigour?
 (ii) Determination of the ABO blood groups.

(b) In fruit flies the body colour and eye colour genes are sex linked. A Cross between yellow bodied white-eyed females and grey bodied red-eyed males produced females which were grey bodied red-eyed. When the F₁ females were back crossed with their male parents, the resulting males comprised the following:

1330 yellow bodied white-eyed flies

26 yellow bodied red eyed flies

35 grey bodied white eyed flies

1297 grey bodied red eyed flies.

- (i) Explain with the aid of diagrams the results obtained
 (ii) What would be the genotypes and phenotypes of the female offspring from mating F₁ females with yellow-bodied white-eyed males?

56. (a) Describe the general structure and chemical composition of a transfer ribonucleic acid (t-RNA) molecule.

(09 Marks)

(b) Describe how the genetic information stored in the DNA is translated into a protein.

(11 Marks)

57. (a) In cats the allele for short hair is dominant to the allele for long hair; the gene involved is autosomal.

Another gene which is sex-linked produces hair colour; its alleles produce black or white coat colour, and the heterozygote combination produces tortoise-shell colour. If a long-haired black male is mated with a tortoise-shelled female homozygous for short hair, what kind of offspring will be produced in F₁? (08 m

(b) Explain the inheritance of the ABO blood groups in man. (08 marks)

(c) What is the role of mutation in evolution? (04 marks)

58. (a) Explain how semi conservative DNA replication occurs in an eukaryotic cell.

[12 marks]

(b). Explain the role of DNA in controlling the process of polypeptide synthesis in a cell.

59. (a) Describe the structure of the tRNA molecule.

[06 marks]

(b) What are the characteristics of a genetic code?

[05 marks]

- (c) Compare the structure of tRNA and DNA. [09 marks]
60. (a) Describe the structure of nucleic acids. (06 Marks)
 (b) Compare the processes of eukaryotic DNA replication and transcription. (06 marks)
 (c) Explain how meiosis can result in an almost infinite genetic variety. (08 marks)
61. In the garden pea, *Pisum sativum*, the dominant alleles of two unlinked genes, **A/a** and **B/b**, are needed to make the pods tough and inedible. All other genotypes result in soft, edible 'sugar-snap' pea pods.
- Pods with genotypes including the dominant allele **A** have a thin layer of cells lining the pod.
 - Pods with genotypes in which the recessive allele **a** is homozygous have no thin lining layer.
 - Pods with genotypes including the dominant allele **B** have lignin added to the thin lining layer, when it is present.
 - Pods with genotypes in which the recessive allele **b** is homozygous do not have added lignin.
- (a) Explain the phenotypes of pea pods with the following genotypes: (04 marks)
- (i) **AAbb**
 - (ii) **aaBB**
- (b) Two pea plants of genotypes **AAbb** and **aaBB** were interbred to give an **F₁** generation and these in turn were interbred to give an **F₂** generation. Using an appropriate genetic cross, including gametes, show the genotypes and phenotypes of the **F₁** and **F₂** generations. Give the ratio of phenotypes expected in the **F₂** generation. (10 marks)
- (c) Gene **R** for red flower colour can only express itself phenotypically in the presence of gene **C** which complements its action to form colour. When two white-flowered plants with genotypes **CCrr** and **ccRR** were crossed, the **F₁** generation all had red flowers. What would be the phenotypic ratio of the **F₂** progeny when the **F₁** progeny are selfed? (Show your working). (06 marks)
62. (a) Explain how interaction at one loci and between loci can affect phenotypic variation. (09 marks)
 (b) How does natural selection increase adaptation of a species of the environment? (11 marks)
63. (a) Distinguish between translation and transcription (03 marks)
 (b) Give an account of the process of translation in a cell (12 marks)
 (c) What is the significance of translation in a living cell (03 marks)
64. (a) What is meant by the term **linkage** as used in inheritance (02 marks)
 (b) Briefly explain why identical twins are very important in genetics (02 marks)
 (c) In tomatoes, the allele for red fruit, **R** is dominant to that for yellow fruit, **r**. The allele for tall plant, **T** is dominant to that for short plant, **t**.
- i. A cross was made between two tomato plants and the possible genotypes of the gamete of the male were: RT, Rt, rT and rt while that of the female were rt. What are the genotypes and phenotypes of the male and female parents? (02 marks)
 - ii. What proportions of the resulting offspring from the genetic cross in (c) (i) above would you expect to have red fruits?
 Use a genetic diagram to explain your answer (05 marks)
- (d) In cats the gene controlling the coat colour are carried on the **X**-chromosomes and are co-dominant. Female cats are usually homogametic while males are heterogametic.
- A black coat male produced a litter consisting of only black males and tortoise shell female kittens. What is the expected **F₂** phenotypic ration? Explain your answer (09 marks)
65. (a). What is meant by the term **linkage**? [03 marks]

- (b) A homozygous purple-flowered short stemmed plant was crossed with a homozygous red flowered, long stemmed plant. The F₁ phenotypes had purple flowers and short stems. When F₁ generation was test crossed, the following genotypes were produced;

Phenotype	Number of plants
Purple flowered - short stemmed	52
Purple flowered – long stemmed	47
Red flowered – short stemmed	49
Red flowered – long stemmed	45

- (i) Using relevant illustrations, account fully for the results [14 marks]
 (ii) Do the results indicate linkage, explain your answer. [03 marks]
66. Both haemophilia and colour blindness are transmitted in the same way
- What are the effects of each disease? (04 marks)
 - Describe the transmission of the diseases. (08 marks)
 - Explain why there are more colourblind individuals than hemophiliacs among the human population in spite of the similar way of transmission. (08 marks)
67. (a) Distinguish between **codominance** and **pleiotropy**. (04 marks)
 (b) In cats, the genes controlling fur colour are carried on the X chromosomes and are codominant. The homozygous conditions are black fur and ginger fur. The intermediate condition is tortoiseshell. A black female mated with a ginger male. What is the expected phenotypic ratio in the F₂ generation? (10 marks)
 (c) Explain why sex-linked traits are most common in males among humans. (06 marks)
68. In the fruit fly, *Drosophila melanogaster*, the genes for broad abdomen and long wing are dominant over the genes for narrow abdomen and vestigial wing. Pure-breeding strains of the double dominant variety were crossed with a double recessive variety and a test cross was carried out on the F₁ generation.
- Using suitable symbols, work out the expected phenotypic ratio of the test cross of the F₁ generation, if the genes for abdomen width and length of wings are linked. (07 marks)
 - It was however observed that when the test cross of the F₁ generation was carried out, the following results were obtained:
- | | |
|---------------------------------|-----|
| Broad abdomen, long wings | 380 |
| Narrow abdomen, vestigial wings | 396 |
| Broad abdomen, vestigial wings | 14 |
| Narrow abdomen, long wings | 10 |
- Explain the above results (03 marks)
 - Using appropriate genetic crosses show how the above results are obtained. (07 marks)
 - Calculate the distance in units between the genes for abdomen width and length of wing (03 marks)
69. (a). How does meiosis explain **Mendel's law of inheritance**? [06 marks]
 (b). Describe how abnormal haemoglobin arises in the human population [09 marks]
 (c). Explain the effects of the gene for abnormal haemoglobin in the human population. [05 marks]
70. A sex-linked gene controls fur colour in cats. **Ginger-coloured fur** is controlled by the allele **G**, and **black-coloured fur** is controlled by the allele **g**. Some cats, exclusively females are described as **tortoiseshell** because of having **ginger** and **black** patches of fur.
- Using suitable genetic symbols, work out the genotypes and the ratio of phenotypes expected in the offspring of the cross between a male cat with genotype **X^GY** and a **tortoiseshell** female cat. (06 Mark)

- (b) The effect of the **G** and **g** alleles is modified by another gene which is not sex-linked but has two alleles. The allele **d** changes the **ginger** colour to **cream** and the **black** colour to **grey**. The dominant allele **D** does not modify the effect of **G** or **g**.

Using suitable genetic symbols, work out the genotypes and the ratio of phenotypes expected in the offspring of the cross between a **cream-coloured** male cat and **black** female whose genotype was **X^eX^eDd** to produce male kittens of two different colours. (07 Marks)

- (c) (i) With examples from humans, distinguish between **sex-linked** and **sex-limited** genes. (04 Marks)
 (ii) Explain why sex-linked features are more common in men than in women. (03 Marks)

71. In *Drosophila* the genes for wing length and for eye colour are sex-linked. Normal wing and red eye are dominant to miniature wing and white eye.

(a) In a cross between a miniature wing, red-eyed male and a homozygous normal wing, white-eyed female, explain fully the appearance of;

- i. the F₁ and (05 marks)
 ii. the F₂ generations (05 marks)

(b) crossing a female from the F₁ generation above with a miniature wing, white eyed male gave the following results:

normal wing, white-eyed males and females	35
normal wing, red-eyed males and females	17
miniature wing, white-eyed males and females	18
miniature wing, red-eyed males and females	36

- i. Account for appearance and numbers of the phenotypes shown above (06 marks)
 ii. Determine the cross-over value for the results above (03 marks)

72. (a) State eight situations where Mendel's laws would not apply. (08 marks)

(b) How does meiosis explain Mendel's first law of inheritance? (04 marks)

(c) (i) In corn plants a dominant allele **A** inhibits Kernel colour while the recessive allele **a** permits colour formation when homozygous. At a different locus, the dominant allele **R** causes purple Kernels colour while the homozygous recessive genotype **rr** causes red Kernels.

- i. If plants heterozygous at both loci are crossed, what will be the phenotypic ratio of the offspring? (07 marks)
 ii. State the type of gene interaction in C(i) (01 mark)

73. (a)(i) Using examples, differentiate between sex-linked and sex-limited characters. (03 Marks)

- (i) Haemophilia is a condition caused by a recessive gene carried on the X-chromosomes. Determine the chances of producing a normal boy from a carrier mother and a normal father. (04 Marks)
 (b) Suggest three reasons why female haemophiliacs are very rare. (03 Marks)

74. (a) What is the significance of the genetic code to the life of an organism? (08 marks)

- (b) Describe how polypeptides are made at the ribosomes in a cell (08 marks)
 (c) Describe the evidence to show that DNA is a genetic material (04 marks)

75. (a) Compare mitotic prophase and prophase I of meiosis (12 marks)

- (b) State evidences for DNA as the hereditary material (04 marks)

- (c) State the differences between continuous and discontinuous variation (04 marks)
76. (a) Explain why a single base deletion from one DNA molecule usually cause greater effect than replacement of one base by another different base (08 marks)
- (b) Describe how sickle-cell anaemia arises in a population (12 marks)
77. (a) Distinguish between **polygenic** and **pleiotropic** traits (02 marks)
- b) Give an example of a human trait due to (02 marks)
- (I) polygenic inheritance (ii) Pleiotropic inheritance
- b) What is the meaning of the following terms as used in the study of genetics? (02 marks)
- (i) **Segregation**
- (ii) **Independent assortment**
- c) Two unlinked gene loci interact to give variation in coat colour in certain breeds of cats. The dominant allele for colour **B** produces black pigment, the recessive allele **b** gives a cinnamon coat. Allele **D** prevents dilution of coat colour pigment which occurs in animals homozygous for the recessive allele **d**. dilution of the black gives a blue coat and dilution of cinnamon produces fawn.
- Work out the expected probability, phenotypes and genotypes of the offspring from a cross between a heterozygous blue cat and a cinnamon cat. (04 marks)

END

TOPIC 4: CYTOLOGY, MICROSCOPY AND HISTOLOGY

Syllabus extract

<i>Content</i>	SPECIFIC OBJECTIVES <i>The learner should be able to:</i>
<p>Cell structure</p> <ul style="list-style-type: none"> • Structure of the animal cell and plant cell as seen under a light microscope. • Detailed animal and plant cells. • Functions of detailed cell structures indicating the inter relationship. • Differences between plant cell and animal cell ultra-structures. • The theory behind the structure of the plasma membrane. • The fluid mosaic model-plasma membrane. 	<ul style="list-style-type: none"> • Identify plant and animal cell structures visible under the light microscope • Draw and label detailed animal and plant cells. • State functions of cell structures as seen under an electron microscope. • Distinguish between the plant cell and animal cell ultra-structures as visible under the electron microscope • Explain the theory behind the structure of the plasma membrane.
<p>Diversity of Specialized cells and tissues.</p> <ul style="list-style-type: none"> • Differences between Eukaryotic cells and Prokaryotic cells. • Specialised cells and tissues: xylem, phloem, tracheids, sclerenchyma, collenchyma, parenchyma, connective and skeletal tissue. • Function and adaptation of epithelial tissues • Levels of organization: cell, tissue, organ and organ system. • Advantages and disadvantages of being unicellular • Advantages of multicellular state. 	<ul style="list-style-type: none"> • Distinguish between prokaryotes and eukaryotes. • Explain cell and tissue specialization. • Explain how epithelial tissues are adapted to diversity of functions in the body. • Distinguish between the different levels of organization. • State the advantages and disadvantages of being unicellular. • State the advantages of being multicellular.
<p>cell structure and microscopy Practical</p> <ul style="list-style-type: none"> • The functioning principles of a light and electron microscope: resolving power, e.t.c. • Preparation of temporary mounts of cell and tissue slides. • Simple staining methods • Staining plant tissues. • Estimation of cell size. • Epithelial tissues classification. 	<ul style="list-style-type: none"> • Explain the functioning principles of a light and electron microscope • Prepare temporary mounts of cells and tissue slides. • Use simple stains in studying cells and tissues • Identify different plant tissues using different laboratory stains. • Determine cell size • Draw and label epithelial tissues.

CELL BIOLOGY

This deals with cell structure, function and cell physiology all at the unit level of a living organism called a cell. The study of the structure of cells, **cytology**, is part of a major branch of biology known as cell biology.

The main functions of the cell include

1. Basic unit of life. The cell is the smallest part to which an organism can be reduced that still retains the characteristics of life.
2. Protection and support. Cells produce and secrete various molecules that provide protection and support of the body. For example, bone cells are surrounded by a mineralized material, making bone a hard tissue that protects the brain and other organs and that supports the weight of the body.
3. Movement. All the movements of the body occur because of molecules located within specific cells such as muscle cells
4. Communication. Cells produce and receive chemical and electrical signals that allow them to communicate with one another. For example, nerve cells communicate with one another and with muscle cells, causing them to contract
5. Cell metabolism and energy release. The chemical reactions that occur within cells are referred to collectively as cell metabolism. Energy released during metabolism is used for cell activities, such as the synthesis of new molecules, muscle contraction, and heat production, which helps maintain body temperature.
6. Inheritance. Each cell contains a copy of the genetic information of the individual. Specialized cells are responsible for transmitting that genetic information to the next generation

The cell of a living organism

The cell can be defined as the basic unit of structure and function in a living organism. This generalisation is known as the **cell theory** and it embraces four ideas;

- A. The cell is the building block of structures in living cells
- B. The cell is derived from other cells by cell division
- C. The cell contains hereditary information that is passed from parent cell to daughter cell
- D. The cell is the functioning unit of life i.e. the chemical reactions of life takes place within cells

The cell theory states that "**a cell is the fundamental and functional unit of life**" i.e. the cell is the basic unit of the structure and function in living organisms.

Factors that limit cell size

1. Surface area to volume ratio

Small cells have large surface area: Volume ratio (SA: V ratio) while large cells have a small SA: V ratio. A large SA: V ratio enables fast rate of diffusion while a small SA: V ratio slows the rate of diffusion. Small cells have low metabolic demands and form low amount of wastes while large cells have higher metabolic demands and form much amount of wastes.

Therefore, the large SA: V ratio in small cells enables adequate supply of oxygen and nutrients and expulsion of wastes e.g. carbon dioxide via the surface of the cell by simple diffusion while the small SA: V ratio in large cells limits diffusion hence the supply of nutrients by simple diffusion is inadequate to meet the metabolic demands of the cell.

2. Nucleocytoplasmic ratio

DNA in the nucleus provides instructions for protein synthesis hence controls activities of the whole cell. Each nucleus can only control a certain volume of cytoplasm.

Specialization forms some long / large cells, therefore to overcome this limitation such cells are modified to become multinucleate / coenocyte e.g. skeletal muscle cells and fungal hyphae.

3. Fragility of cell membrane

As cell size increases, the risk of damage to the cell membrane also increases. This limits the maximum size of cells, especially animal cells. Hence;

- (i) In animals, some large sized cells take in substances in bulk by endocytosis and expel bulk substances by exocytosis to supplement on simple diffusion.
- (ii) Some animal cells increase their surface area by forming many tiny projections called microvilli.
- (iii) Some cells divide when they reach a certain size to maintain suitable SA: V ratio.

Note: SA: V ratio particularly limits the size of bacterial cells, i.e. prokaryotic cells which are incapable of endocytosis and exocytosis.

4. Mechanical structures that hold the cell together

Cells with tough cell walls e.g. plant cells are larger than cells with only the fragile cell membrane e.g. animal cells because the tough walls provide support and maintain cell shape.

Cells with complex internal cytoskeleton are larger than cells with little cytoskeleton because the cytoskeleton protects and supports the cell structure and maintains cell shape.

TYPES OF CELLS

There are two fundamentally different types of cells, the prokaryote cell and eukaryote cell.

A. Prokaryote cell (Pro, before; karyon, nucleus)

Characteristics of prokaryotic cells

- These are cells that **do not have a true nucleus.**
- They have no membrane bound organelles. An **organelle** can be defined as a membrane-enclosed structure with specialised functions, suspended in the cytosol of eukaryotic cells.
- Their nuclear material lies in a free region known as a **nucleoid** e.g. in bacteria. They were probably the first organisms on earth
- The cell has no distinct nucleus. The nucleoplasm appears scattered in the cytoplasm or the nuclear materials e.g. DNA.
- The cell lacks a nuclear membrane
- Each cell has got very few cell organelles (cell parts) e.g. they do lack the chloroplasts and mitochondria.
- The cell has a single circular chromosome in the form of a ring, of Deoxyribonucleic Acid (DNA) in the cytoplasm, not contained in a nuclear membrane
- They are extremely small, ranging in size between 1-10micrometres in diameter
- Duplication of the chromosomes occurs but not on the spindle i.e. their cells are capable of multiplication
- The cell has got a unique cell wall containing a polysaccharide

Examples include bacteria and cyanobacteria i.e. first organisms on earth.

Diagram of a generalised structure of a bacterium *Fig 2.5 pg 9 Soper*

Function of the parts
Structures which are always present

1. Cell wall

This lies external to the cell membrane, it's rigid and strengthened by presence of murein (a molecule consisting of parallel polysaccharide chains cross-linked at regular intervals by short amino acid chains)
The cell wall is a physical barrier which:

- (i) protects the internal parts from mechanical damage
- (ii) prevents the cell bursting when it takes in water by osmosis
- (iii) allows entry of some substances, such as water, ions and small molecules

The cell wall cannot grow and for growth to occur the cell wall is partly dissolved at intervals for materials to be added.

2. Cell membrane

It lies immediately below the cell wall and has a **fluid mosaic structure**. It's hydrophobic and impermeable to most water soluble molecules.

It has **enzymes** involved in the synthesis of the capsid and cell wall components. Enzymes for respiration and those which facilitate flagella mobility.

Note: a damaged cell membrane leads to the death of the cell.

3. Ribosomes

Prokaryotes have 70S ribosomes which are slightly smaller than the 80S eukaryotic ribosomes.
Ribosomes are site of protein synthesis.

4. DNA

The DNA comprises of a single circular molecule possessing the genetic information needed to replicate new cells

5. Food reserves

Food reserves include lipids and glycogen

6. Cytoplasm

This is enclosed by the cell membrane and is divided into three divisions (bacteria only) i.e.

- (i) Cytoplasmic area which contains ribosomes and it is also a site for protein synthesis.
- (ii) Chromatin area, a dense area which is rich in nucleic acid material. The nuclear region is called **nucleoid**. Bacteria have single circular strand of chromatin material.
- (iii) The fluid area, an area with dissolved substances. In the bacteria the rough endoplasmic reticulum is lacking. The ribosomes are generally smaller than in an eukaryotic cell and are free or attached to the cell membrane.

Structures sometimes present

7. Flagellum (Plural. flagella)

This occurs in many species of bacteria. They are hair like helical appendages protruding through the cell wall. They are used for propulsion. Bacterial flagella are smaller, thinner and simpler than eukaryotic flagella. Their location and number may be used in identification of bacteria.

8. Pili

Pili are numerous fine protein rods projecting from the walls of some bacteria. The pili are for attachment to specific cells or surfaces. The **F.pilus** is used in sexual reproduction.

9. Capsule

This is an enveloping layer of viscous substances around the cell wall. This layer can be detected under the light microscope after staining the bacteria with Indian ink. Its uses include;

- (i) Protecting against infecting phages
- (ii) Resist engulfment by white blood cells
- (iii) Prevents agglutination of bacteria
- (iv) Used by bacteria to stick firmly onto substances e.g. bacteria on teeth

- (v) The capsular secretions are in some cases used to unite bacteria into colonies

10. Plasmids

Plasmids are small self-replicating strands of extra DNA. Plasmids possess only a few genes, and are generally concerned with survival in adverse conditions.

Plasmids are known which;

- a) Confer resistance to antibiotics
- b) Confer resistance to disinfectants
- c) Cause disease
- d) Are responsible for fermentation of milk to cheese by lactic acid bacteria
- e) Confer the ability to use complex as chemicals such as hydrocarbons as fuel

11. Mesosomes

Bacteria lack membrane bound organelles such as mitochondria and chloroplasts. Instead they have invaginations of cell membranes forming a system referred to as mesosomes. There are 2 types; the central and the peripheral mesosomes.

(i) Central mesosomes

These are invaginations which penetrate deep into the cytoplasm. They appear to be linked to the nuclear material and play a role in cell division.

(ii) Peripheral mesosomes

These are shallow invaginations formed by infoldings of the cell membrane. They are associated with export of secretions such as cellular secretions or enzymes. They are site of respiration.

12. Photosynthetic membranes

Photosynthetic bacteria possess sac-like, tubular or sheet-like infoldings of the cell surface membrane containing photosynthetic pigments, always including **bacteriochlorophyll**

13. Spores

Some bacteria form endospores (spores produced inside cells). The spores are thick-walled, long-lived, and extremely resistant (particularly to heat, drought, and shortwave radiations)

14. Membranes for nitrogen fixation

B. Eukaryotic cell (Eu, true; Karyon Nucleus)

These are cells with a true nucleus. Their nuclear materials are found inside the nucleus surrounded by two membranes. They probably evolved about 1000 million years ago, 2 million years after the prokaryotes. There are 2 main types of eukaryotic cells; the plant cell and the animal cell.

Cells as seen with the light microscope

A light microscope is a microscope that uses light as a source of radiation. Under the microscope, cells are described as a small unit of living protoplasm and always surrounded by cell surface membrane and sometimes as in plants, surrounded by a non-living cell wall made of cellulose. The most conspicuous structure is the nucleus which contains a deeply staining material known as chromatin. When loose it is referred to as chromosome. Chromosomes appear as thread like structures just before nuclear division. The living material between the nucleus and the cell surface is known as the cytoplasm which contains a variety of organelles.

A generalised cell is a cell which shows all the typical features found in a cell.

a) Animal cell

An animal cell as seen in a light microscope contains protoplasm (nucleus and cytoplasm) surrounded by a thin plasma membrane.

Each cell has a relatively large central nucleus surrounded by the cytoplasm. The nucleus contains coiled threads called chromatin. Chromatin contains DNA and proteins called histones which together condense to

form chromosome during cell division. DNA carries genetic material which controls cell activities and determines the organism's characteristics. The cytoplasm contains organelles suspended within.

The structure of a generalised animal cell *Fig 5.1 a pg 129 Soper*

b) Plant cell

Many of the structures found in an animal cell also occur in the plant cell. A typical plant cell has additional specialised structures.

The structure of a generalised plant cell (*Fig 5.2 pg 130 Soper*)

There's a protective, rigid, cellulose cell wall surrounding the cell. Plant cells have a nucleus and cytoplasm which are usually peripheral. The cytoplasm contains chlorophyll pigments which carry out photosynthesis. A large central vacuole filled with cell sap is present in mature plant cells. The vacuole is surrounded by the tonoplast

Description of a generalised structure of a eukaryotic cell.

A cell is a small unit of living protoplasm, always surrounded by a cell surface membrane and sometimes by a non-living cell wall (as in plants and fungi).

The most conspicuous structure of the cell is the nucleus which contains chromatin. Chromatin is the loosely-coiled form of chromosomes. Chromosomes contain genetic material in the form of DNA. The nucleus is separated from the cytoplasm by its nuclear membrane

The cytoplasm contains organelles.

Comparison between prokaryotic and eukaryotic cells

Similarities	Differences	
	Prokaryotes	Eukaryotes
a. The protoplasm is surrounded by a membrane that is selectively permeable (protoplasm = nucleoplasm + cytoplasm) b. The binding protein is made up of lipid-protein complex c. The cells have got ectoplasmic and nuclear regions	The nuclear material is not enclosed by nuclear membrane	The nuclear material is enclosed by nuclear membrane
	Genetic material is circular double strand of DNA	Most DNA is linear and associated with histones proteins to form chromosomes
	No membrane bound organelles	Has membrane bound organelles
	No mitosis or meiosis	Mitosis, meiosis or both can occur
	No spindle formation	There's spindle formation
	Ribosomes are smaller (70S)	Ribosomes are bigger (80S)
	Rigid cell wall containing murein (peptidoglycan)	Cell walls of plants and algae contain cellulose, fungi contain chitin and animal cells have no cell walls
	No mitochondria (mesosomes in bacteria and plasma membrane of cyano bacteria contain respiratory enzymes)	Mitochondria present and function as sites for cellular respiration to produce ATP.
	Use mesosomes for respiration	No mesosomes
	Flagella if present, contain flagellin and lack microtubules	Flagella, if present, have a '9+2' arrangement of microtubules
	Average diameter of cell is 0.5-5µm	Average diameter of cell is 10-100µm
	Some bacteria have small circular DNA plasmids	Plasmids are absent
	Few organelles	Many organelles
No chloroplasts (some prokaryotes are photoautotrophs with the photosynthetic membranes not stacked into grana)	Chloroplasts containing grana	

NOTE: the only organelle found in animal cells which is absent from plant cells is the centriole

Advantages of having membrane bound organelles

1. Potentially harmful reactions (enzymes) can be isolated inside an organelle so that they do not harm the rest of the cell
2. The rate of any metabolic reactions inside an organelle can be controlled by regulating the rate at which the membrane allows the first reaction to occur or to enter
3. The containment of enzymes for a particular metabolic pathway within the organelle means that the products of the reaction will always be in close proximity to the next enzymes within the sequence. This increases the rate of metabolic reactions
4. Many metabolic processes which involve enzymes occur in the membrane.

MICROSCOPY

Microscopy is the science that studies structure, magnification, lenses and techniques related to the use of microscopes. A microscope is an instrument that magnifies images of very tiny objects to show great details.

Units of measurements and magnification

Magnification is the number of times that an image is larger than the specimen i.e. the ration of an object's

image size to its real size and is usually given by the formula: $\text{Magnification} = \frac{\text{size of image}}{\text{size of specimen}}$

The units of measurement used in cell biology are shown in the table below

Units for measurement of a cell

Unit	Relation to a millimetre	Relation to a metre
Angstrom (Å)	10^{-7}	10^{-10}
Nanometer (nm)	10^{-6}	10^{-9}
Micrometer (μm)	10^{-3}	10^{-6}
Milietre		10^{-3}
Centimeter	10^1	10^{-2}

Or 1 meter = 10^2 cm = 10^3 mm = 10^6 μm = 10^9 nm = 10^{10} Å

Worked examples

<p>1. An animal cell of $60\mu\text{m}$ length is enlarged photographically. An enlargement print is made showing the cell at 12cm. What is its magnification? $1\text{cm} = 1 \times 10^4 \mu\text{m} = 10,000\mu\text{m}$ $12\text{ cm} = 12 \times 10,000 = 120,000 \mu\text{m}$ $\text{Magnification} = \frac{120,000}{60} = \text{X}2,000$</p>	<p>2. A plant cell is magnified X2000 and the length of the chloroplast in the diagram is 16mm. Calculate the actual length of the chloroplast in μm $1\text{mm} = 1 \times 10^3 \mu\text{m} = 1,000 \mu\text{m}$ $16\text{ cm} = 16 \times 1000 = 16,000 \mu\text{m}$ $\text{Magnification} = \frac{\text{size of image}}{\text{size of specimen}}$ $\text{X}2000 = \frac{16000}{\text{size of specimen}}$ $\text{Actual size of specimen} = \frac{16,000}{2000} = 8 \mu\text{m}$</p>
---	---

Resolution (resolving power)

Resolution is a measure of the clarity of the image i.e. the minimum distance two points can be separated and still be distinguished as two points. For example, what appears to the unaided eye as one star in the sky may be resolved as twin stars with a telescope.

The **limit of resolution** of a microscope is the minimum distance between two points at which they are still distinguished as two separate points. If the two points cannot be resolved, they will be seen as one point. A microscope with a high resolving power will enable two small objects close together to be seen as two separate objects. A microscope with a low resolving power will cause the two small objects close together to be seen as one object.

Light microscope (LM)/optical microscope

All the microscopes you are likely to use in the laboratory are all LMs. In the LM, light rays passing through a specimen are brought to focus by a set of glass lenses. The resulting image can be seen by the human eye.

Visible light used in the LM has a wave length of about 400-700nm. The maximum resolution of an optical microscope is about 200nm, which gives a maximum magnification of about 1500 times.

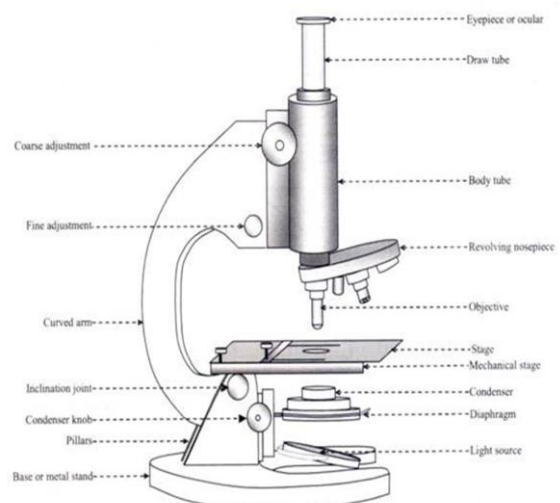

Organelles such as chloroplasts (about 3000nm in diameter) are large enough to interfere with the light waves and can be seen. Ribosomes (about 20nm) are too small to interfere with the light waves and cannot be seen under a light microscope.

Phase contrast microscope

Many cell details cannot be seen using an ordinary optical microscope. This is because there is very little **contrast** between structures. They have similar transparency and are not coloured. A third important parameter in microscopy is *contrast*, which emphasizes or makes more noticeable, differences in parts of the sample. New methods of improving contrast include staining or labelling cell components to stand out visually.

Special phase contrast condensers and objective lenses are added to the optical microscope. Light rays travelling through material of different densities are bent and altered giving a better contrast (cell components having different densities show variation in the refractive index, those of a higher refractive index can bend light to greater angle than other cell components of lower refractive index).

Phase contrast microscopes enable **living, non-pigmented specimen** to be studied without fixing and staining. Phase contrast microscopes give better contrast but do not improve resolution. This is similar to the optical microscope.

Just as the resolving power of the human eye is limited, the light microscope cannot resolve detail finer than about 0.2 μ m or 200nm, the size of a small bacterium, regardless of the magnification factor. The poor resolution of the LM could only be overcome by using a form of radiation with a wave length less than of light. This led to the development of the **electron microscope (EM)**. Since electrons have a shorter wavelength than light (about 0.005nm), they couple their higher magnifying power with much greater resolution and contrast. They can resolve two objects which are only about 1nm apart.

While the light microscope uses glass lenses to focus the light rays, the electron beam of the electron microscope is focused by powerful electromagnets. The image produced by electron microscopes cannot be seen by the unaided eye. Instead the electron beam is directed onto a screen giving black and white images (photographs). A photograph taken with an electron microscope is called an **electron micrograph** or **photomicrograph**.

There are two types of electron microscopes; the **Transmission Electron Microscope (TEM)** and the **Scanning Electron Microscope (SEM)**.

A TEM is an electron microscope in which the electron beam is transmitted through the specimen before viewing. The principle is the same as in the light microscope in that a beam of radiation is focused by condenser lenses through the specimen, and the image is magnified by further lenses. The TEM has a resolving power of about 1nm. It used to study the **ultrastructure** of a cell.

The electron beam is heated using a cathode and passed through ultra-thin dehydrated sections of dead specimen. Electrons are absorbed by heavily stained (due to treatment with heavy metals) parts but pass through the lightly stained parts. This provides contrast between different parts of the specimen.

Drawing of the pathway of the electron beam in the TEM (Soper pg 133)

A SEM is an electron microscope in which the electron beam is scanned to and from across the specimen. The electrons reflected from the surface are collected and used to form a TV-like image on a cathode ray tube. This enables the studying of the surfaces of structures and gives three-dimensional images. The SEM has a resolving power of about 5nm higher than that of a light microscope, but lower than that of a TEM. Larger and thicker specimens can be examined.

Note: the fine structure of the cell as seen with the electron microscope is called the **ultra-structure**.

Differences between the light and electron microscopes

TEM	Compound light microscope
1. Source of radiation are electrons	1. Source of radiation is light
2. Electrons have a shorter wavelength of about 0.005nm	2. Light has a longer wave length of about 400-700nm
3. Maximum resolution is greater (about 0.5nm)	3. Maximum resolution is lower (about 20nm)
4. Maximum useful magnification on screen is higher (about X250,000)	4. Magnification is low (about X1500)
5. Uses powerful electromagnets as lenses	5. Uses glass lenses
6. The specimen is dead, dehydrated and relatively small or thin	6. The specimen maybe living or non-living
7. The specimen is supported on a small copper and in a vacuum	7. The specimen is supported on a glass slide
8. The stains used contain heavy metals to reflect electrons	8. The stains used are coloured dyes
9. The image is black and white	9. The image is usually coloured

A comparison of radiation pathways in light and transmission electron microscopes

A comparison of the relative advantages and disadvantages of the light and electron microscopes

Light microscope	Electron microscope
<p style="text-align: center;"><u>Advantages</u></p> <ol style="list-style-type: none"> Cheaper to produce and operate Smaller and more portable; thus can be used almost anywhere Not affected by magnetic fields Preparation of material is relatively quicker and simpler, and requires only a little expertise and simpler equipment Material rarely distorted by preparation The natural colour of the material can be observed The specimen may be living The specimen does not deteriorate easily, allowing more study time 	<p style="text-align: center;"><u>Disadvantages</u></p> <ol style="list-style-type: none"> Much more expensive to purchase and operate Much larger and fixed, and must be operated in special rooms Affected by magnetic fields Preparation of material is lengthier and requires more expertise and more complex equipment Material is usually distorted by the preparation (preservation and staining may change or damage the structure) All images are in black and white The specimen must be dead because it is viewed in a vacuum The specimen gradually deteriorates in the electron beam, and thus photomicrographs must be taken and observed on the screen
<p style="text-align: center;"><u>Disadvantages</u></p> <ol style="list-style-type: none"> Lower magnification of up to X1,500 Has a restricted depth of field Lower resolution of about 200nm 	<p style="text-align: center;"><u>Advantages</u></p> <ol style="list-style-type: none"> Higher magnification of up to X250,000 Enables investigation of a greater depth of field Higher resolution of about 0.5nm

CELL STRUCTURE**Differences between plant and animal cells**

Plant cells	Animals cells
<ol style="list-style-type: none"> Have tough slightly elastic cellulose cell wall outside the cell surface membrane Have pits and plasmodesmata in the cell wall Have middle lamellae joining the cell walls of adjacent cells Possess plastids, such as chloroplasts Mature cells possess a large single, central vacuole filled with cell sap The cell vacuole is enclosed by a tonoplast Have a thin layer of cytoplasm confined to the edge of the cell The nucleus is located at the edge of the cell Higher plant cells lack centrioles Higher plant cells lack cilia and flagella Store food as starch grains 	<ol style="list-style-type: none"> Have no cell wall, only a cell surface membrane surrounds the cell Have no cell wall, and therefore have no pits and plasmodesmata Middle lamellae are absent, the cells are joined by intercellular cement Lack plastids Possess only small vacuoles scattered throughout the cells Vacuoles lack tonoplasts Have much cytoplasm spread throughout the cell The nucleus is usually placed centrally in the cell Possess centrioles Often possess cilia and flagella Store food as glycogen granules

12. Only some cells are capable of division	12. Almost all cell are capable of division
13. Plant cells produce secretions	13. Animal cells produce a wide variety of secretion
14. Have a regular shape	14. Have an irregular shape

a) **The ultra-structure of a generalised animal cell** (Soper fig 5.10 page 135)

b) **The ultra-structure of a generalised plant cell** (Soper fig 5.11 page 135)

Detailed study of animal and plant cells.

Cell membrane

The cell membrane is invisible with a light microscope.

Danielli and **Davison** proposed a membrane structure in which a lipid bilayer was coated on either side with a protein so as to provide the mechanical strength (elasticity and surface tension properties) to the cell membrane. This hypothesis proposes that the plasma membrane is made up of three layers: a bimolecular layer of lipid sandwiched between two layers of protein, the lipid molecules being set at right angles to the surface i.e. the **sandwich model** of the cell membrane

Diagram of the cell membrane based on the Danielli-Davison hypothesis

Fig 2.21 pg 27 Roberts

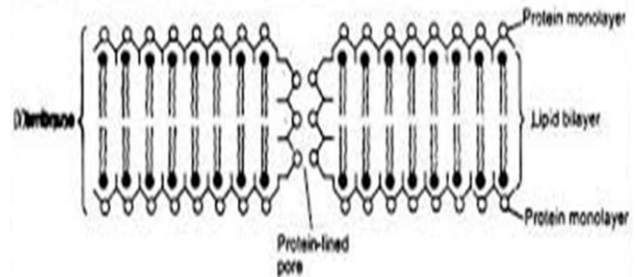

From the speeds at which various molecules penetrate the membrane, they predicted the lipid layer to be about 6.0nm in thickness, and each of the protein layers about 1.0nm giving a total thickness to the membrane of about 8.0nm.

Robertson (1960) used an electron microscope to observe a cell membrane and proposed that a cell membrane is actually a **unit membrane**. According to his proposal, all membranes have the same structure. A unit membrane has protein molecules with lipid molecules inside. The head of the lipid molecules are in mutual electrostatic attraction with the protein molecules, this increases on the mechanical strength of the unit membrane.

Fig 2.22 pg 27 Roberts

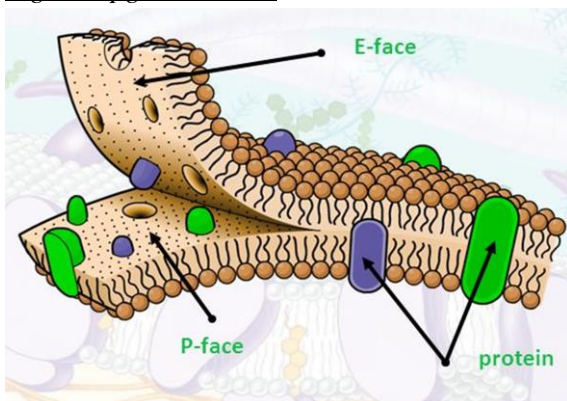

The unit membrane has pores that are lined with protein molecules which enable water soluble substances to enter or leave the membrane. Such substances include, water molecules, mineral salts, simple sugars, vitamins, gasses and excretory products. The membrane has got lipid layers which enable the lipid molecules to enter and leave the membrane.

Most of the proteins on the cell membranes are called carrier proteins i.e. they enable the transport of substances across the membrane. Other proteins are enzymes in nature i.e. they catalyse biochemical reactions at the cell surface

In 1972 **Singer** and **Nicolson** suggested that the unit membrane has a **fluid mosaic model**

- The fluid mosaic model proposes that the basic structure for the unit membrane is a phospholipid bilayer with various protein molecules embedded and attached to it.
- The hydrophilic phosphate heads of the phospholipids face outwards into the aqueous environments inside and outside the cell and form hydrogen bonds with water molecules.
- The hydrocarbon tails face inwards and create a hydrophobic interior through Van der Waal forces and hydrophobic interactions. The phospholipids are fluid and move about rapidly by diffusion in their own layers. Some of the fatty acid tails are saturated and some are unsaturated. Unsaturated tails are bent and fit together more loosely. Therefore the more unsaturated the tails are, the more fluid the membrane is.
- Most protein molecules float about in the phospholipid bilayer forming a fluid mosaic pattern and these proteins stay in the membrane because they have regions of hydrophobic amino acids which interact with the fatty acid tails to exclude water.

- The membrane proteins most of which float individually in the fluid bilayer, forming the mosaic part of the fluid mosaic model. The rest of the protein is hydrophilic and faces into the cell or out into the external environment, both of which are aqueous. Some proteins penetrate only part of the way into the membrane (extrinsic proteins) while others penetrate all the way through (intrinsic proteins).
- Some proteins and lipids (phospholipids) have short branching carbohydrate (oligosaccharides) chains forming glycoproteins and glycolipids respectively, more glycoproteins are formed than glycolipids. These are important for cell recognition.
- Membranes also contain cholesterol which disturbs the close packing of phospholipids and regulates membrane fluidity. This is important for organisms living at low temperatures where membranes can solidify. Cholesterol also increases flexibility and stability of membranes, without it, membranes break up.

Fig 5.16 b pg 142 Soper OR Fig 7.15 pg 159 Cross-sectional view Clegg

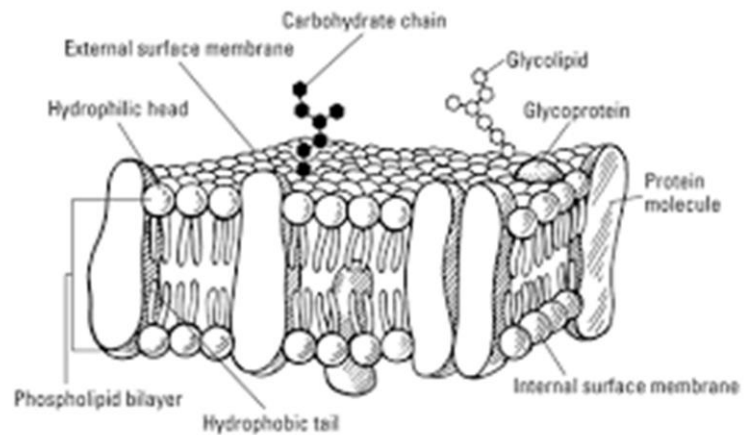
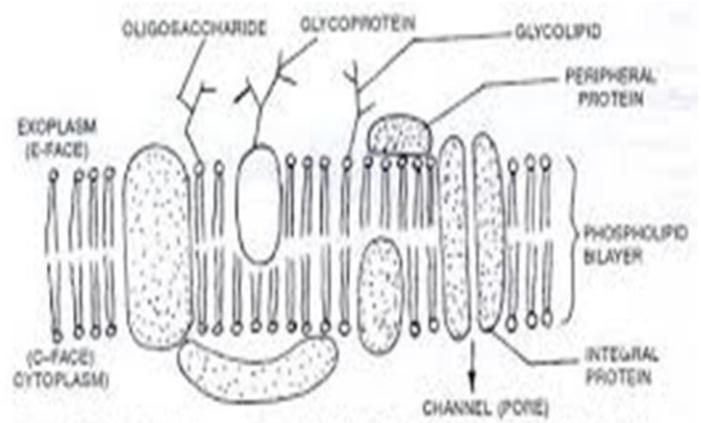

A comparison of the sandwich model (Daniel-Danielli) and the fluid-mosaic model (Singer-Nicholson) of the cell membrane

a) Similarities

- (i) Both comprise of a bimolecular layer of phospholipids
- (ii) Both contain protein molecules
- (iii) In both, the phospholipids possess hydrophilic heads and hydrophobic tails
- (iv) In both, the phospholipid tails extend inwards, while the heads lie at the periphery
- (v) In both, the main structural skeleton of the membrane comprises lipids and proteins

b) Differences

Sandwich model	Fluid-mosaic model
1. Proteins regularly arranged to form a continuous layer covering both sides of the membrane	1. Proteins arranged irregularly in a mosaic pattern
2. Proteins lie on the surface, and do not get in the membrane	2. Some globular proteins lie on the surface, some extend into the lipid layer to varying degrees, and others extend through it
3. Lipids and proteins are rigid and cannot move	3. Lipids and proteins capable of much movement like a fluid
4. Protein molecules are of the same size	4. Proteins molecules are of different sizes
5. Proteins lack pores	5. Some proteins have pores
6. All proteins offer structural support only	6. Proteins may be structural, carrier proteins or enzymes

How phospholipid properties maintain cell membrane structure

1. Hydrophilic / hydrophobic layers restrict entry/ exit of substances.
2. Phospholipids are held together by hydrophobic interactions
3. Phospholipid layers are stabilized by interaction of hydrophilic heads and surrounding water
4. Phospholipids with short fatty acids and those with unsaturated fatty acids are more fluid. Fluidity is important in breaking and remaking membranes (e.g. endocytosis / exocytosis)
5. Phospholipids can move about / move laterally (horizontally) / "flip flop" (move transversely) to increase fluidity
6. Phospholipids allow for membrane fluidity/ flexibility. Fluidity/ flexibility enables membranes to be functionally stable

Membrane fluidity

Membranes are fluid, dynamic structures whose fluidity/viscosity is affected by their composition.

- a) An increase in temperature increases the fluidity of the membrane. Low temperature decreases membrane fluidity because lipids are laterally ordered, the lipid chains pack well together, mobility reduces to allow many stabilising interactions. Increase in temperature increases membrane fluidity because lipids acquire thermal energy to become mobile and reduce stabilising interactions.
- b) At moderate warm temperatures, the cholesterol molecules reduce the free movement of phospholipid molecules and make the membranes less fluid. At low temperatures, cholesterol molecules prevent the close packing of phospholipid molecules and slow down solidification of the membrane.
- c) Lipid chains with double bonds (unsaturated fatty acids) are more fluid because the kinks caused by double bonds make it harder for the lipids to pack together. Lipids that have single bonds only (saturated fatty acids) have straightened hydrocarbon chain which pack together to reduce membrane fluidity.
- d) Lipids with shorter chains are more fluid because they quickly gain kinetic energy due to their smaller molecular size and have less surface area for Van der Waals interactions to stabilise with neighboring hydrophobic chains. Lipids with longer chains are less fluid because their large surface area enables more Van der Waals interactions hence increasing the melting temperature.

Functions of the unit membrane

- 1) Surface membrane forms a protective barrier between cell contents and external environments, and determines the shape of the cell.
- 2) They form membrane organelles e.g. mitochondria, chloroplasts e.t.c.
- 3) Membranes are selectively permeable and regulate movement of substances in and out the cell
- 4) Some membrane proteins act as enzymes e.g. ATP synthase
- 5) Cell surface receptor proteins are involved in signal-transduction
- 6) Some membrane proteins act as electron carriers in the electron transport chain
- 7) Glycoproteins with branching oligosaccharides act as antigens
- 8) Glycolipids are involved in cell-cell recognition
- 9) Folding of cell membranes enables the cell to carry out phagocytosis and pinocytosis which enables the cell to obtain nutrients or to engulf and destroy foreign particles.
- 10) Folding of membranes also increases the surface area for reactions e.g. the epithelium villus of the ileum
- 11) Cell adhesion proteins join cells together forming tissues which carry out specific functions
- 12) Cholesterol molecules stabilise the membrane structure and reduce entry or exit of polar molecules through the membrane

Note; the various membranes of an eukaryotic cell are different because only certain proteins are unique to each membrane.

Molecules and ions can pass through the plasma membrane in four ways:

- a) **Directly through the phospholipid membrane.** Molecules that are soluble in lipids, such as oxygen, carbon dioxide, and steroids, pass through the plasma membrane readily by dissolving in the lipid bilayer. The phospholipid bilayer acts as a barrier to most substances that are not lipid-soluble; but certain small, nonlipid-soluble molecules, such as water, carbon dioxide, and urea, can diffuse between the phospholipid molecules of the plasma membrane.
- b) **Membrane channels.** There are several types of protein channels through the plasma membrane. Each channel type allows only certain molecules to pass through it. The size, shape, and charge of molecules determines whether they can pass through a given channel. For example, sodium ions pass through sodium channels, and potassium and chloride ions pass through potassium and chloride channels, respectively. Rapid movement of water across the cell membrane apparently occurs through membrane channels.
- c) **Carrier molecules.** Large polar molecules that are not lipidsoluble, such as glucose and amino acids, cannot pass through the cell membrane in significant amounts unless they are transported by carrier molecules. Substances that are transported across the cell membrane by carrier molecules are said to be transported by carrier-mediated processes. Carrier proteins bind to specific molecules and transport them across the cell membrane. Carrier molecules that transport glucose across the cell membrane do not transport amino acids, and carrier molecules that transport amino acids do not transport glucose.
- d) **Vesicles.** Large nonlipid-soluble molecules, small pieces of matter, and even whole cells can be transported across the cell membrane in a vesicle, which is a small sac surrounded by a membrane. Because of the fluid nature of membranes, the vesicle and the cell membrane can fuse, allowing the contents of the vesicle to cross the cell membrane.

Role of proteins within the plasma membrane

1. Anchoring cells. Membrane proteins anchor cells to the cuticle membrane, and also to microfilaments within the cell.
2. Transport. Membrane proteins form channels that allow selective passage of ions or molecules, for example carrier proteins during facilitated diffusion.
 - Some carrier proteins pump solutes across membranes by active transport
3. Enzyme activity. Some membrane proteins are enzymes that catalyse reactions that are placed within or along the surface of the membrane.
4. Signal transduction. Receptor proteins bind with signal molecules such as hormones and neurotransmitters, and transmit information into the cell
5. Cell recognition. Proteins function as identification tags for cells
6. Junction between cells. Cell adhesion proteins of different cells together
7. Energy transducers and electron carriers. In photosynthesis and respiration, membrane proteins take part in energy transfer
8. Structural support. The various proteins dotted throughout the biphospholipid layer provide structural support to the cell membrane.

Evidence for the fluid-mosaic model of the cell membrane

- a. Pieces of the cell membrane treated from one side with chemicals which react with the proteins but cannot pass through the membrane behave differently.
In some cases, the reactions are confined to the side of the membrane to which the chemicals are applied, while in other cases they occur on both sides, suggesting that this particular proteins span the entire membrane.

- b. Using freeze-fracture technique, a piece of the cell membrane is frozen, then split down the middle longitudinally. If there's inner surface is then viewed in the electron microscope, globular structures of the same size as the membrane proteins can be seen scattered about as shown below

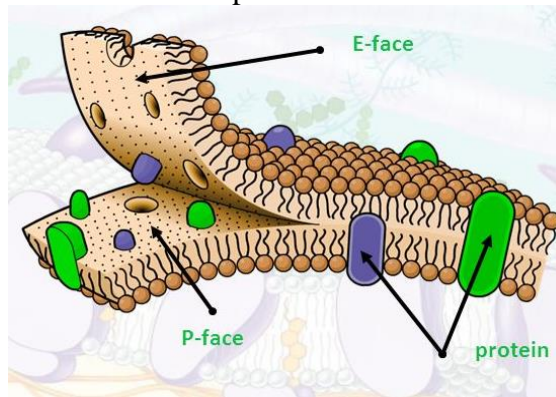

- c. Experiments on membrane viscosity suggest that it is of a fluid consistency rather like oil, and shows considerable side movements of the lipid and protein molecules within it.

The cytoplasm

The cell organelles are contained within the cytoplasmic matrix (cytoplasm). The cytoplasm is an aqueous material forming a solution or colloidal suspension of many fundamental biochemicals of life, including ions such as sodium, phosphates and chlorides; organic molecules such as amino acids, ATP, fatty acids, nucleotides, vitamins; dissolved gases and storage material such as oil droplets.

The cytoplasm is capable of mass flow in a process cytoplasmic streaming. The cytoplasm is important for important biochemical processes.

The nucleus

This is the central region in both plant and animal cells with a diameter of 4-10 μ m. In this region, all the cell activities are directed e.g. cell division and protein synthesis. A nucleus can be seen with the ordinary microscope. The nuclei have got various shapes depending on the cells e.g. oval, spherical or lobed. Mammalian red blood cells (erythrocytes) and phloem sieve tube elements don't have a nucleus. A distinct nucleus is present at some stage in the cells of all forms except in bacterial cells, blue green- algae and viruses.

- The nucleus has a double layered nuclear membrane (unit membrane). The outer membrane is continuous with the endoplasmic reticulum. The perinuclear space occurs between the two membranes.
- The nuclear membrane has got nuclear pores, which regulate exchange of substances between the nucleoplasm and the cytoplasm. The nuclear membrane pores are routes for the passage of large molecules such as mRNA, from the nucleus to the cytoplasm and this happens during protein synthesis. The nuclear pores can only be seen using an electron microscope.
- Inside the nuclear membrane, we find nucleic acids (DNA and RNA) and proteins. The nuclear DNA is bonded to a number of proteins which are called histones which appear as chromatin in a non-dividing cell. During nuclear division, the chromatins become visible as chromosomes and the nuclear membranes disappear. During Interphase, some of the chromatin strands are tightly coiled and are called heterochromatin. The remaining loosely coiled chromatin is called euchromatin. Inside the nucleus, there is a nucleolus which makes ribosomes and ribosomal RNA.
- The nucleus contains one or more small spherical bodies called nucleoli which manufacture ribosomal RNA (rRNA) and assemble ribosomes. A nucleolus contains RNA and DNA.

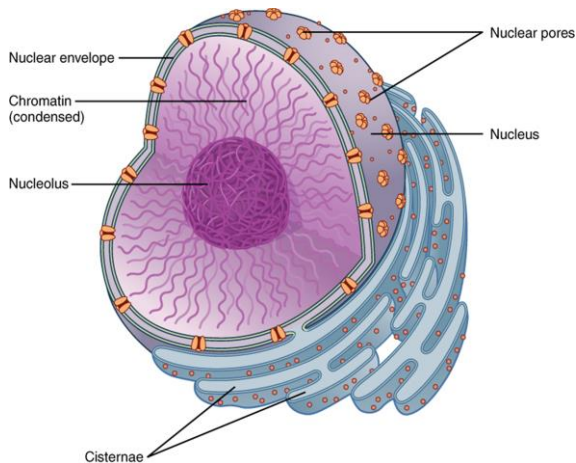

Functions of a nucleus

1. Chromosomes in a nucleus contain the genetic material of the cell
2. The nucleus acts as the centre to control cell activities and cell division
3. Production of ribosomes and RNAs needed for protein and enzymes synthesis
4. Formation of the ribosomal RNA by nucleolus.
5. Nuclear division gives rise to cell division hence reproduction.

Adaptations of the nucleus to its function

- 1) DNA is long to store many genes
- 2) Nuclear membrane has pores for exchange of DNA and RNA between the nucleus and cytoplasm
- 3) Presence of nucleolus that produces ribosomes which are protein factories
- 4) Nuclear envelope that isolates nucleus from interference by processes in cytoplasm
- 5) Nuclear pores are narrow to regulate entry and exit of substances

Mitochondria

Mitochondria appear as rod-shaped or cylindrical organelle, although occasionally they are more variable in shape with a length of about 2.5-5 μ m and a diameter of 1 μ m.

Each mitochondrion is bound by a double membrane, the outer layer being a continuous smooth boundary. Between the two membranes is the intermembrane space. The inner membrane is extensively in folded to form partitions called Cristae (consisting of a head piece, stalk and base piece), which partially divide the interior. The Cristae in plants are commonly tubular and villus-like; in animal cells they are sheet-like plates. The inner membrane holds the oxysome and encloses a fluid filled space called the matrix. The matrix contains enzymes and DNA, the DNA directs or codes the synthesis of proteins within the mitochondria i.e. mitochondria multiply during cell division.

Fig 7.21 pg 163 Clegg OR Fig 162 B & C pg 162 Monger

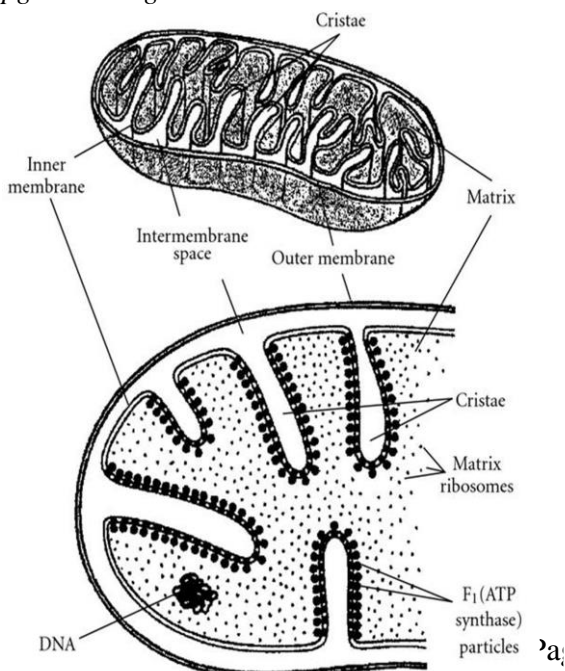

Functions

1. They are sites of ATP formation
2. They are sites of aerobic respiration

NOTE; Mitochondria are prominent in organs where there's a lot of metabolic activity e.g. kidney nephron, muscle fibres, neurone axons, tail of the sperm and root hairs.

Adaptations of the mitochondria to its function (energy production)

1. The double membranes separate the mitochondrion from interference by processes in the cytoplasm
2. small size gives a large surface area to volume ratio for the rapid uptake / release of materials
3. matrix contains enzymes of the Krebs cycle
4. inner membrane invaginates (in-folds) forms cristae to increase the surface area for electron transport chain (oxidative phosphorylation)
5. inner membrane has cristae with oxysomes that contain ATP synthetase (ATPase) on stalked particles that make ATP

6. narrow intermembrane space (gap between inner and outer membranes) enables pH / H⁺ / proton concentration gradient to be rapidly established / steeper chemiosmosis therefore more efficient / chemiosmosis can occur
7. inner membrane contains molecules for electron transport pathway
8. DNA is present to act as genetic material for synthesis of some protein / control of metabolism
9. Presence of many ribosomes for protein synthesis to reduce on importation of some proteins
10. Phosphate used in glycolysis thru protein carriers (not clear)

Comparison between the structure of the nucleus and the mitochondria

a. Similarities

- Both contain DNA
- Both contain RNA
- Both contain ribosomes
- Both contain enzymes
- Both are bound by a double membrane

b. Differences

Nucleus	Mitochondrion
1. Linear DNA	1. Circular DNA
2. DNA contained in chromosomes	2. DNA not contained in chromosome
3. Larger 80S ribosomes	3. Smaller 70S
4. Membrane has pores	4. Membrane has no pores
5. Inner membrane not folded	5. Inner membrane folded to form cristae
6. Oval or spherical	6. Sausage shaped, spiral or cup-shaped
7. Outer membrane continuous with endoplasmic reticulum	7. Outer membrane not continuous with any organelle
8. Ribosomes may be attached to outer membrane	8. Ribosomes not attached on outer membrane

Chloroplast

Chloroplasts are members of a group of organelles known as **plastids**. Plastids normally contain pigments such as chlorophylls and carotenoids and bound by 2 membranes. They develop from small bodies called proplastids found in the meristematic regions. There are mainly two types of plastids and they are both found in plant cells.

The **leucoplasts** are colourless and are found in plant parts which are not exposed to sunlight; these parts include roots and underground stems. They are the food storage organelles. There are three types of leucoplasts;

1. In the amyloplasts, sugar is converted into starch
2. In the elaioplasts, there's synthesis and storage of lipids
3. In the aleuroplast, there's synthesis and storage of proteins

Chromoplasts are coloured pigments containing non-photosynthetic pigments, common in fruits, carrot root tissue and in flower petals

Structure

- Chloroplasts are biconvex in shape, 4-10µm in diameter, 2-3µm thick.
- They are bound by a double unit membrane, like chloroplasts, but in addition chloroplasts have a third membrane called the thylakoid membrane. This is folded into thin vesicles (the thylakoids), enclosing small spaces called the thylakoid lumen (lamellae). The thylakoid vesicles are often layered in stacks called grana, which contain photosynthetic pigments. The thylakoid membrane contains the same ATP synthase particles found in mitochondria.

- The interior of the chloroplast is divided into the grana which are surrounded by an aqueous matrix called stroma, into which the lamella is suspended.
- Chloroplasts contain DNA, tRNA and ribosomes, and they often store products of photosynthesis as starch grains and lipid droplets.

Fig 4.5 a & b pg 56 Toole.

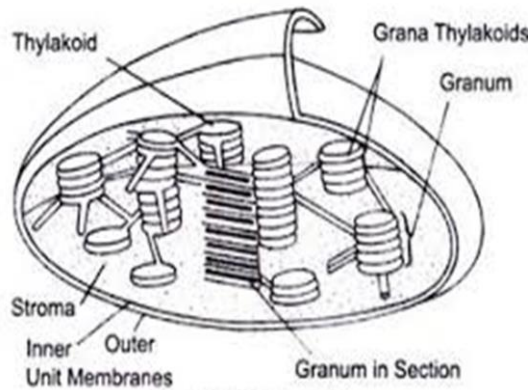

Adaptations of chloroplasts to their function

1. Chloroplasts of flowering plants have a biconvex shape which increases the surface area for the exposure of the photosynthesis pigments.
2. It has a double membrane with an outer membrane (surface) membrane which prevents the photosynthetic reactions from mixing with those in the cell cytoplasm.
3. The surface membrane is permeable to gases like carbon dioxide which is a raw material for photosynthesis.
4. The internal membrane also contains electron transport systems which synthesize ATP.
5. It contains chlorophyll for trapping sunlight energy.
6. It has thylakoids that increase the surface area for holding chlorophyll molecules.
7. The thylakoid granum is connected by intergrana membranes thus maintaining the thylakoids and chlorophyll stationary in position.
8. The stroma of the chloroplast has DNA and ribosomes for protein synthesis.
9. The stroma contains the necessary enzymes for protein synthesis.

Comparison of chloroplast and mitochondrion

Similarities:	Differences	
	Chloroplast	Mitochondrion
Both:		
a. are enclosed by double membrane	Site of photosynthesis	Site of respiration
b. contain DNA	Contains thylakoid membranes	Lacks thylakoid membranes
c. contain 70S ribosomes	Contains photosynthetic pigments that absorb light	Lacks photosynthetic pigments
d. have electron transport chain	There is light generated ATP production	ATP production by oxidation of organic molecules
e. produce ATP by chemiosmosis	H ⁺ gradient across thylakoid membrane	H ⁺ gradient across inner membrane
f. contain ATP synthase /ATPase	Cristae absent	Cristae present
	Larger size	Smaller size

Microvilli

Microvilli are tiny finger-like extensions of the cell surface membrane or certain animal cells, such as those of the intestinal epithelium. Microvilli are massed together forming a brush border at the edge of cell bearing them.

Each microvillus contains bundles of actin and myosin filaments, causing the microvilli to contract. Microvilli provide a large surface area for absorption and digestion.

Ribosomes

Ribosomes are tiny organelles with a diameter of about 20nm, made of ribosomal RNA and protein. They carry out protein synthesis. Each ribosome consists of two sub-units, one large and one small. There are two types of ribosomes: 70s are found in prokaryotes, mitochondria, chloroplasts and are the slightly larger 80s ribosomes

occur in the cytoplasm of eukaryotes.

When several ribosomes occur along a common strand of mRNA, the whole structure is known as a polysome or a polyribosome.

Bound and free ribosomes are structurally identical, and ribosomes can alternate between the two roles.

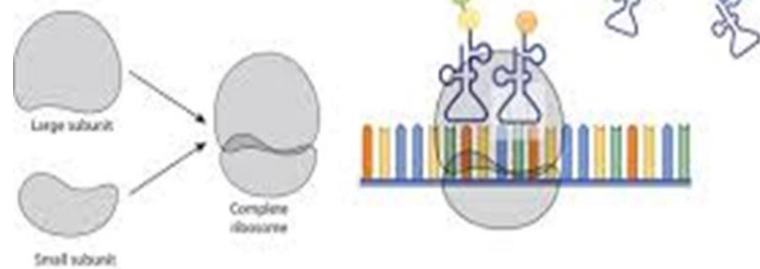

Ribosomes lying free in the cytoplasm are the site of synthesis of proteins that are retained within the cells, e.g. enzymes that catalyse the first steps of sugar breakdown and haemoglobin in young red blood cells. Ribosomes bound to endoplasmic reticulum produce proteins that are subsequently secreted outside the cell e.g. proteins inserted into membranes for packaging within certain organelles (lysosomes) or for export from the cell.

Cells that specialise in protein synthesis have a high proportion of bound proteins and a prominent nuclei e.g. cells of the pancreas that secrete digestive enzymes.

Endoplasmic reticulum

Endoplasmic reticulum (ER) consists of a network of folded membranes forming sheets, tubes or flattened sacs in the cytoplasm. It forms a cytoplasmic skeleton called a cytoskeleton. The tubules and sacs are called cisternae.

ER is flexible and mobile since it occupies much of the cytoplasm of many cells, including those in which streaming movements of the cytoplasm occur. *It therefore forms an intracellular transport system and a cytoplasmic skeleton of the cell.*

Functions of ER

1. Offer increased surface area for cellular reactions.
2. Form part of the cell's skeletal framework
3. Transporting proteins and carbohydrates to other organelles like lysosomes, Golgi apparatus, and plasma membrane.
4. Form the nuclear membrane during cell division.

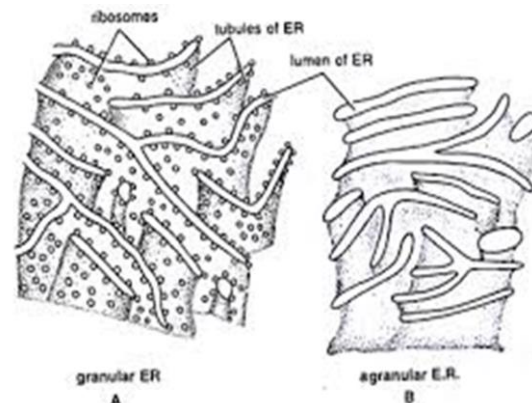

Fig. 298. Structure of endoplasmic reticulum. A, Rough ER; B, Smooth ER.

Rough ER (RER) consists of an interconnected system of membrane-bound flattened sacs. It is continuous with the outer membrane of the nucleus and has many minute globular bodies called ribosomes. The RER isolates and transports proteins manufactured by ribosomes, mainly secreted proteins for export i.e. those that the cell does not need but are needed elsewhere e.g. enzymes and hormones. RER is abundant in cells which are rapidly growing or secretory cells e.g. pancreatic cells.

Functions of RER

1. Rough ER is concerned with the transport of proteins which are made by ribosomes on its surface
2. The protein is extensively modified as it passes through the cisternae e.g. converting it into a glycoprotein.
3. Checks the quality of proteins formed, especially correct ordering and structure.

Smooth ER (SER) is a system of interconnected tubules and it lacks ribosomes. SER is abundant in cells involved in lipid and steroid hormone synthesis e.g. cells in the testes and ovaries or cells involved in detoxification e.g. liver cells.

Functions of SER

1. Enzymes of SER are important in the synthesis of lipids including oils, phospholipids and steroids e.g. lipids from fatty acids and glycerol in the epithelium of the intestine. Testes and ovaries are rich in SER because they secrete steroid hormones
2. Other enzymes of SER detoxify drugs, alcohol and poisons, especially in the liver
3. SER becomes modified to form the sarcoplasmic reticulum surrounding the muscle myofibrils
4. SER attaches receptors to cell membrane proteins in plant cells
5. Synthesis and repair of membranes by producing cholesterol and phospholipids
6. For metabolism of glycogen in the liver e.g. glucose-6-phosphatase enzyme in SER converts glucose-6-phosphate to glucose.
7. Contains enzymes that detoxicate lipid soluble drugs, alcohol and metabolic wastes from the liver
8. The SER also stores calcium ions
9. Pathway for the transport of materials through the cell

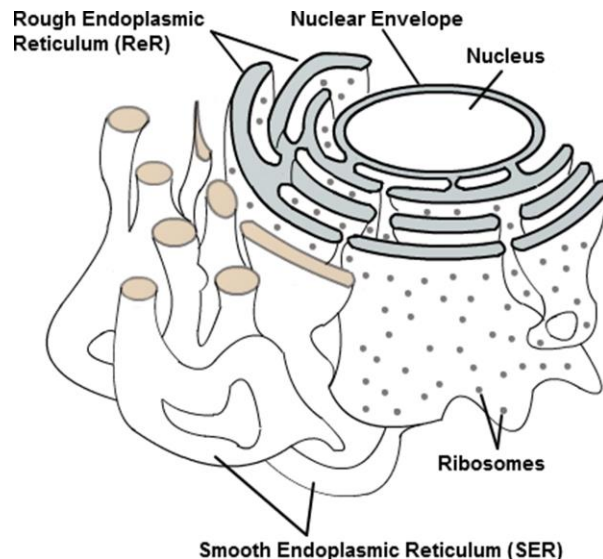

Adaptations of ER to its function

1. The interconnected network provides the cell with skeletal framework.
2. Forming an extensive network increases the surface area for metabolic reactions e.g. protein synthesis at RER.
3. The endoplasmic reticulum membrane compartmentalizes the cytoplasm (isolates lumen from cytosol), which;
 - Enables transporting soluble and well packaged substances to their specific destinations.
 - Prevents interference of different metabolic processes taking place in the cell at the same time.
4. Contains a variety of enzymes for performing diver roles in cell metabolism.
5. The SER is modified into sarcoplasmic reticulum storage and release of calcium ions.
6. The membrane has a variety of proteins that offer unique properties including signal reception.
7. The RER membrane has sites for attachment of many ribosomes for protein synthesis

Lysosomes (suicide bag)

These are tiny membrane bound organelles that contain hydrolytic enzymes. Lysosomes occur only in animal cells and there are primary and secondary lysosomes. The primary lysosomes are tiny vesicles from the Golgi body while the larger secondary lysosomes are formed when the primary lysosomes fuse with small vacuoles of the animal cells.

They are usually absent in plants except insectivorous plants e.g. *Nepenthes*, *Dionaea*.

Lysosomal enzymes work best in the acidic environment found in lysosomes. If a lysosome breaks open or leaks its contents, the released enzymes are not very active because the cytosol has a neutral pH. However, excessive leakage from a large number of lysosomes can destroy a cell by *autodigestion*.

Particles taken in by cells or made in the cell are digested on the lysosome. Lysosomes contain enzymes e.g. lipase which hydrolyses lipids to fatty acids and glycerol, carbohydrases which hydrolyse carbohydrates to simple sugars, peptidases which hydrolyse peptides to amino acids, RNA-ase, DNA-ase, and others.

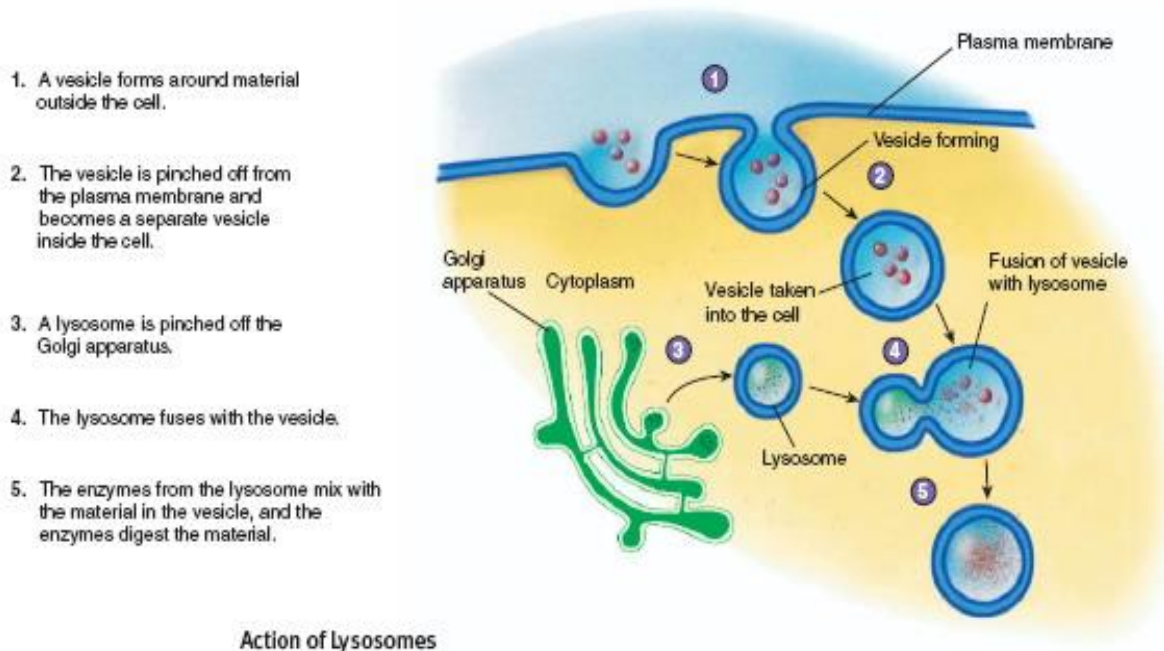

Fig 5.32 pg 155 Soper OR Fig 7.20 pg 162 Clegg

Functions

1. Digestion of materials taken in by endocytosis. The digestion may be for nutrition or defensive purposes. After its action, the products of digestion are absorbed, assimilated and the vacuole migrates to the cell surface membrane and releases its contents.
2. Release of enzymes outside the cell. This occurs during replacement of cartilage by bone during development or bone remodeling after injury.
3. On the sperm head is an organelle called acrosome which is actually a lysosome, it contains enzymes that enable the sperm to penetrate the ova.
4. Autolysis. This is the process by which the lysosome releases its contents into the cell i.e. a suicide bag. Autolysis occurs during reabsorption of the tail of a tadpole and returning the nucleus to its normal size after delivery
5. Autophagy. This is the process by which unwanted structures within the cell are engulfed and digested within the lysosomes.



1. Cleavage of organic substances.
2. The destruction of dead cell organelles.
3. The destruction of cells fulfilled.

Golgi apparatus/body

It is called a dictyosome in plants.

Golgi consist of a stack of flattened, membrane bound sacs called cisternae, together with a system of associated vesicles called Golgi vesicles. They are abundant in secretory cells and in rapidly dividing cells e.g. pancreatic cells, goblet cells, cells in testes and ovaries.

NOTE: at one end of the stack, new cisternae are constantly being formed by vesicles from the SER.

Mode of action of the Golgi

- i. Proteins made at RER have, as part of their amino acid sequence, a signal that directs them where to go:
- ii. Proteins arriving at cis-Golgi but having RER retention signal (were wrongly sent), are repackaged into vesicles then returned to RER.
- iii. Soluble or properly folded macromolecules (proteins, lipids and polysaccharides) from RER enter cis-Golgi network via transport vesicles
- iv. Within cis-cisternae, macromolecules are partly modified i.e. carbohydrates are added to proteins (glycosylation), phosphate is added to protein (phosphorylation) e.t.c.
- v. After partial modification, coated vesicles bud (pinch) off the swollen ends of cis-cisternae and fuse with ends of medial cisternae.

Fig 4.10 pg 60 Toole OR Fig 2.10 pg 19 Roberts OR Fig 2.19 pg 162 Clegg

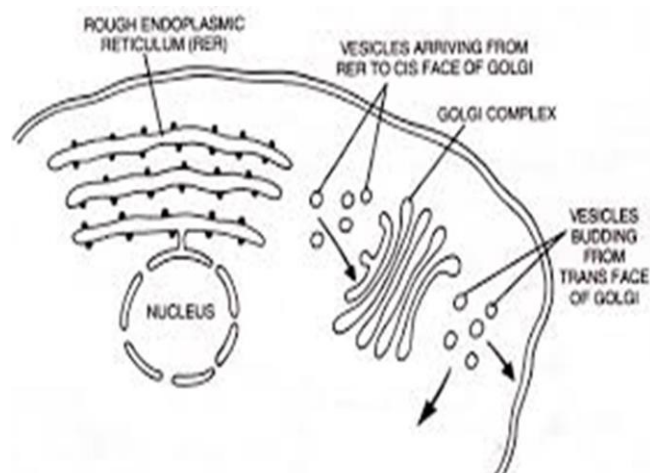
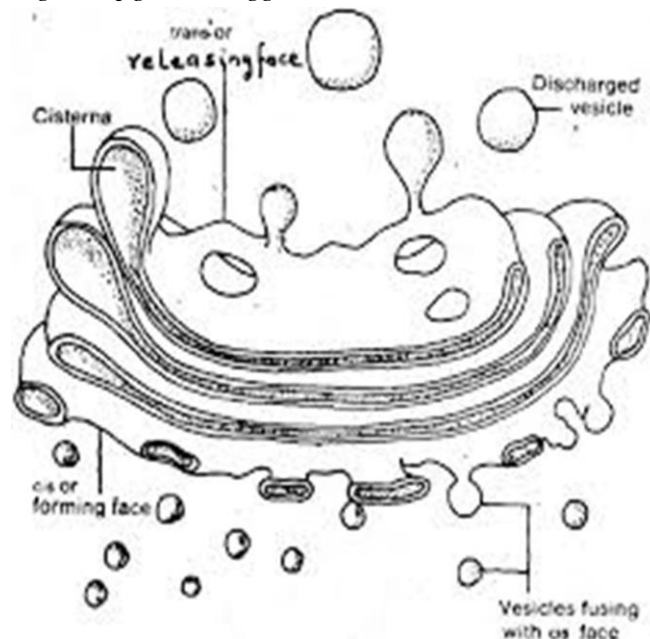

From trans-cisternae, the transformed macromolecules exit the Golgi and are sorted into different transport vesicles destined for lysosomes, plasma membrane or storage vesicles for secretion.

Within medial-cisternae, different enzymes further transform macromolecules differently, depending on their structures and destination i.e. some are modified for secretion, others for the membrane, and some for lysosomes.

After further modification within the medial-cisternae, coated vesicles bud (pinch) off the swollen ends of the medial-cisternae and fuse with the ends of trans-cisternae for further transformation

- a) Vesicles containing hydrolase enzymes fuse with membranes of growing lysosomes so that the contents of both structures fuse.
- b) Vesicles containing hormones e.g. insulin remain until when signaled by the cell, the vesicles then fuse with plasma membrane to release (secrete) the hormone outside the cell by exocytosis.
- c) Vesicles containing membrane proteins fuse with the cell membrane and some of the modified proteins become part of the cell membrane e.g. protein receptors.

1. Some proteins are produced at ribosomes on the surface of the rough endoplasmic reticulum and are transferred into the cisterna as they are produced.
2. The proteins are surrounded by a vesicle that forms from the membrane of the endoplasmic reticulum.
3. The vesicle moves from the endoplasmic reticulum to the Golgi apparatus, fuses with its membrane and releases the proteins into its cisterna.
4. The Golgi apparatus concentrates and, in some cases, modifies the proteins into glycoproteins or lipoproteins.
5. The proteins are packaged into vesicles that form from the membrane of the Golgi apparatus.
6. Some vesicles, such as lysosomes, contain enzymes that are used within the cell.
7. Secretory vesicles carry proteins to the plasma membrane, where the proteins are secreted from the cell by exocytosis.
8. Some vesicles contain proteins that become part of the plasma membrane.

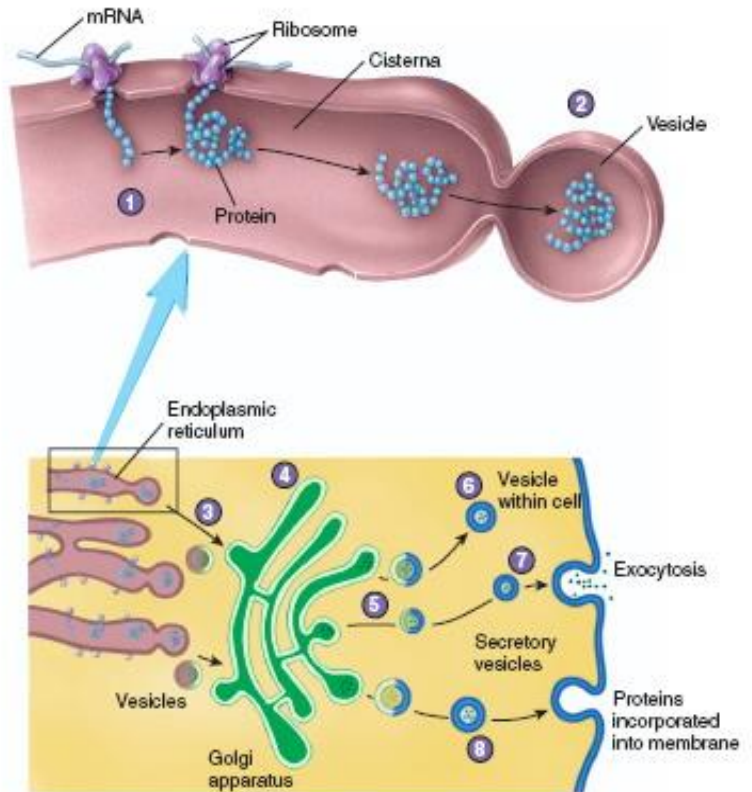

Function of the Golgi Apparatus

Functions

1. The function of the Golgi apparatus is to transport and chemically modify the materials contained within it.
2. Golgi apparatus forms lysosomes containing hydrolytic enzymes
3. Golgi is involved in the formation of peroxisomes
4. Golgi apparatus in the leaf glands of some insectivorous plants e.g. sundews secrete a sticky slime and enzymes which trap and digest insects
5. The membranes of the vesicles from the Golgi apparatus form the first layer of the new cell wall that develops between the two daughter cells as they divide.
6. Golgi is sometimes involved in the secretion of carbohydrates e.g. polysaccharides are attached to a protein to form proteoglycans present in the extracellular matrix of the animal cell
7. To form carbohydrates.
8. Transport of lipid molecules around the cell.
9. Secretory vesicles produced by Golgi contain a variety of important substances e.g.

neurotransmitters, hormones, mucin, zymogen e.g. pepsinogen, etc.

10. Fusion of Golgi vesicles with cell membrane maintains the membrane which is used to form phagocytic vacuoles and Pinocytic vesicles
11. They form lysosomes if or when they contain digestive enzymes

Adaptations of the Golgi

- a) Cisternae are enclosed by permeable membranes, which isolate the inside cavity from cytosol for efficient functioning.
- b) Tubular structure enables transportation of soluble protein and lipids from the endoplasmic reticulum for modification.
- c) Variety of enzyme systems for modifying proteins by adding carbohydrates and phosphate by the process of glycosylation and phosphorylation respectively.
- d) Many cisternae increase the surface area for modifying synthesised macromolecules.
- e) There are many compartments at the cis, located at the beginning of the Golgi apparatus to facilitate passage of proteins through the Golgi apparatus

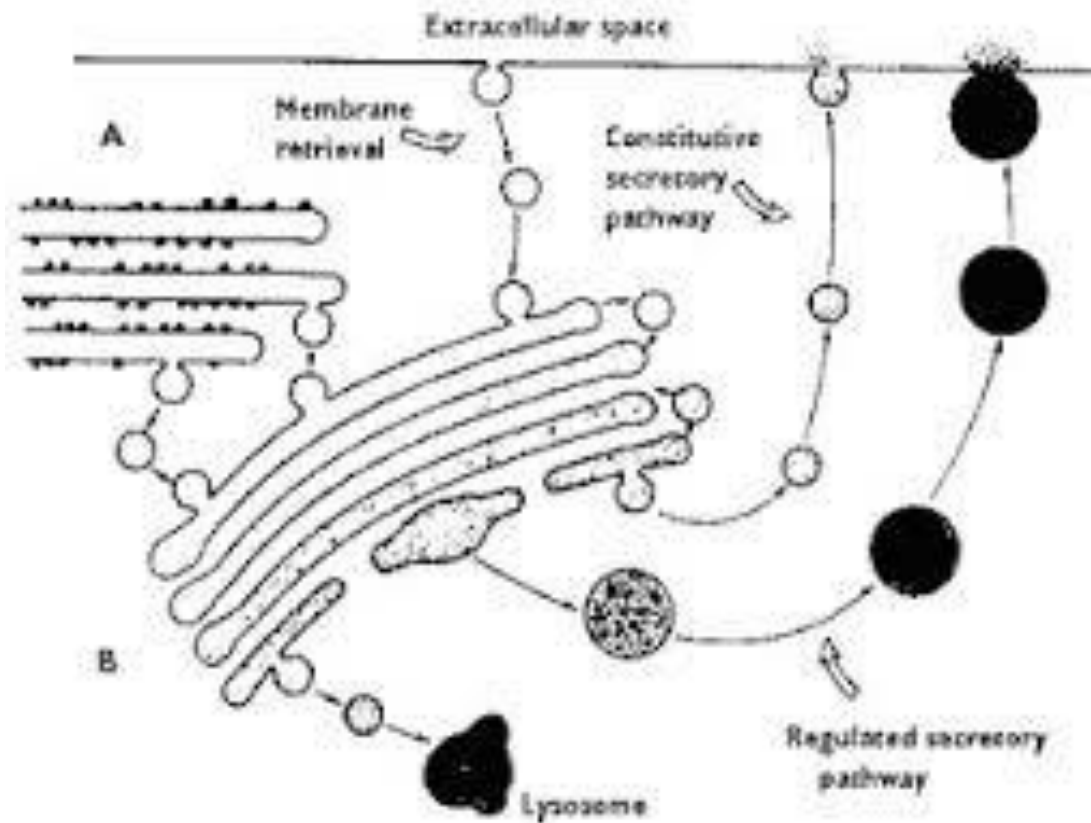

Plant cell wall

It has fibres of cellulose that contain several units of glucose cellulose fibres. Each fibre has several microfibrils. These are strands of cellulose in a crystalline state and these cellulose molecules are held in a matrix by hydrogen bonds. The matrix consists of pectic acid, calcium and magnesium pectate and hemicelluloses. Hemicelluloses are polymers of various pectose and hexose sugars. Pectic substances also make up most of the middle lamella. The middle lamella binds adjacent plant cells to one another. The cell wall is interrupted by pores which carry strands of cytoplasm called plasmodesmata. This cytoplasm facilitates the movement of substances between adjacent cells as well as the deposition of cellulose during the thickening of secondary cell wall.

The young plant cells are made up of the primary wall. These cells are usually found in the growing regions of plants i.e. the meristems e.g. the shoot and root apex. The primary wall is thin, plastic and it allows the cell to grow. Inside the primary wall develops the secondary wall which is thicker due to more cellulose fibres being laid down as the cell grows. The cellulose fibres are closely packed and are laid down in an orderly way.

The secondary wall is impregnated with lignin which is an alcohol polymer and this lignin gives strength to cells of the xylem and the sclerechyma. The secondary cell wall tends to be rigid and tangile. This characteristic brings about the death of the cell because the essential nutrients from the cytoplasm can no longer move across the pores through the cell wall.

In the cork tissue, the tissue between primary and secondary wall, is a fatty substance called suberin. The cork (phloem) cells are formed by the cork cambium (phellogen) prevents the passage of water and gases into and out of the woody plants.

The outer walls of the leaves and young stems are made up of cells called epidermal cells. These cells are covered by a waxy polymer called cutin. Which is secreted by the cytoplasm and it passes through the primary

wall and the middle lamella to appear on the epidermis. Cutin provides a water proof covering to the aerial surface of the plant.

Functions

1. Mechanical strength and skeletal support is provided for individual cells and for the plant as a whole
2. Cell walls are fairly rigid and resistant to expansion and therefore allow development of turgidity when water enters by osmosis
3. Orientation of cellulose microfibrils limits and controls cell growth and shape because the cell's ability to stretch is determined by their arrangement
4. The system of interconnected cell wall (apoplast) is a major pathway of movement for water and dissolved salts
5. Cell walls develop a coating of waxy cutin, the cuticle, on exposed epidermal surfaces reducing water loss and risk of infection
6. The walls of xylem vessels and sieve tubes are adapted for long distance translocation of materials through the cells
7. The cell wall of root endodermal cells are impregnated with suberin that forms a barrier to water movement
8. Some cells walls are modified as food reservoirs as in storage of hemicelluloses in some seeds.
9. The cell walls of transfer cells develop an increased surface area and the consequent increase in surface area of the cell surface membrane increases the efficiency of transfer by active transport
- 10.

Adaptation of the cell wall to its function

- a) The cell wall has cellulose polymers associate through very many H-bonds whose cumulative bonding energy provides high tensile strength of the cell wall for providing support and preventing rupturing
- b) The cell wall has relatively thick multiple wall layers provide mechanical support
- c) The cell wall has secondary walls which may be cutinized / suberinised for preventing water loss
- d) The variety of functional proteins like oxidative enzymes (peroxidases), hydrolytic enzymes (pectinases, cellulases) enable performing several functions like protection against pathogens, cell expansion, cell wall maturation
- e) The cell wall has extremely rigid secondary walls that provide compression strength
- f) Deposition of cellulose fibrils in alternating layers enables some degree of flexibility
- g) The cell wall is semi-permeable in nature to allows exchange of water, dissolved salts and small protein molecules

Comparison between pant cell wall and plasma membrane		
Similarities	Differences	
(Group assignment)	Cell wall	Plasma membrane
	Number of main layers / regions varies (2 or 3)	Number of main layers / regions constant
	Skeleton mainly made of carbohydrates / polysaccharides	Skeleton mainly made of phospholipids
	More permeable to molecules	Less permeable to molecules
	Lacks transmembrane proteins	Transmembrane proteins present
	Plasmodesmata present	Plasmodesmata absent
	May be lignified and suberinised	Lacks lignification and suberinisation
	Has middle lamella	Lacks middle lamella
	Secondary thickening occurs	Lacks secondary thickening

Flagella and cilia

These are organelles that project from the surface of cells but are connected to a basal body just below the membrane.

Flagella occur singly or in small numbers, whereas cilia occur in large numbers on larger cells, and are typically shorter than flagella.

Flagella and cilia are enclosed by a plasma membrane. Internally, they consist of microtubules arranged in an outer ring of nine pairs surrounding two central pairs ('9 + 2' arrangement).

Flagella and cilia move by means of sliding movements of one member of a microtubule pair relative to the other.

Fig 4.15 b pg 63 Toole OR Fig 2.16 pg 23 Roberts

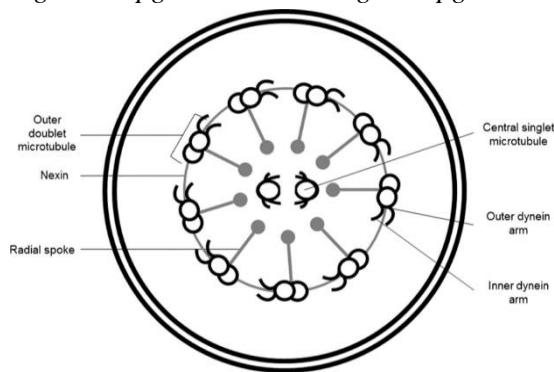

Functions

1. In moving cells e.g. sperm, chlamydomonas spp e.t.c.
2. To propel fluids across cells of ciliated cells that move mucus along the brachial lining
3. To acquire food e.g. the feeding current generated by paramecium in its oral groove
4. To sense the environment e.g. sensory hair cells

Microbodies

These are small spherical membrane-bound bodies of 0.5-1.5µm in diameter. The two common types of microbodies are peroxisomes and glyoxysomes.

Peroxisomes contain oxidative enzymes e.g. catalase. Glyoxysomes are found in the fat tissues of germinating seedling such as those of peanut plants. Glyoxysomes contain enzymes that catalyse the conversion of fats and oils into sugars until the germinating seedlings can produce their own sugars through photosynthesis.

Middle lamella

This is a membrane that holds adjacent plant cells together. It is called the basement membrane in animal cells to form a tissue. The middle lamella is made up of calcium pectate.

Vacuoles

Vacuoles are fluid cavities bound by a single membrane. They are formed either by infolding or pinching off of part of the cell membrane, or by enlargement of a vesicle cut off by the Golgi apparatus.

Young plant cells usually contain several small vacuoles which, in the mature cell, have united to form a large permanent, central vacuole. The plant vacuole is filled with a liquid known as a cell sap, an aqueous solution

Centrioles

Centrioles are found in animal cells. The centrioles are located outside the nucleus in a material of poorly defined structure called the centrosome. Centrioles are paired cylinders of about 0.3-0.5µm long and 0.24µm in diameter which are held at right angle to each other. Each cylinder consists of nine triplets of microtubules in a '9+0' arrangement.

Functions

- a. Centrioles act as organizers of spindle fibres and are involved in the separation of chromosomes or chromatids during cell division
- b. In some cells, centrioles divide to produce basal bodies from which flagella and cilia develop.

Microfilaments

These are long fibres of about 6-7nm in diameter. They are made up of two actin protein strands intertwined together.

Functions

1. Component of cytoskeleton; give support and maintain cell shape
2. Actin and myosin filaments are needed for muscle contraction
3. Constriction of filaments causes cleavage and furrow formation in cytokinesis of animal cells
4. They play a role in cellular movements e.g. cytoplasmic streaming, cell motility, involved in phagocytosis and pinocytosis.

of dissolved food materials, ions, waste products and pigments. The membrane around this type of vacuole is known as the tonoplast.

The vacuoles of animal cells are usually very small and less permanent, called vesicles. They may contain engulfed solids or liquids.

Functions of vacuoles

1. In plants, the vacuole functions to store food substances e.g. sugars
2. The concentrated cell sap causes water to enter by osmosis and the cell becomes turgid. Turgidity brings about support in herbaceous plants and plays a role in enlargement and growth of young plant cells
3. Vacuoles of some plant cells e.g. petals of flowers; contain coloured pigments to attract insects for pollination.
4. Vacuoles in leaves accumulate waste products e.g. tannins and are removed when the leaves fall
5. Food vacuoles formed by endocytosis enable bulk intake of large food particles
6. Contractile vacuoles in unicellular organisms e.g. amoeba and paramecium, regulate water content in the cell.

Protoplasm

This is the living material that comprises of the cytoplasm and the nucleoplasm. The cytoplasm is the protoplasm outside the nucleus and it has all other organelles e.g. mitochondria, RER and other cell contents e.g. glycogen in animal cells, liquid droplets, starch granules in plant cells, salts e.g. NaCl.

The nucleoplasm is the cytoplasm bound by the nuclear membrane. Chromatins are found within the nucleoplasm and later form the chromosomes.

The protoplasm is a colloidal system i.e. a solution with suspended particles in it e.g. cell organelles and food nutrients

Microtubules

These are straight unbranched hollow cylinders, 25nm wide and usually short in strength. They are made of protein and constantly being built up and broken down.

Functions

1. They are involved in the movement of cytoplasmic components within the cell.
2. Microtubules appear to direct the passage of Golgi vesicles to deposition sites.
3. Along with the microfilaments, the microtubules constitute the cytoskeleton, which controls the shape and movement of the cell
4. They are used in cell wall formation
5. They also occur in basal bodies, centrioles, in the spindle, in cilia and flagella

Distribution and function of membranes of cells

- a) Membranes of cells is not limited only to the cell membrane (plasma membrane), which forms the cell boundary plus its various modifications, it also includes all other membranes enclosing some organelles and some cytoplasmic inclusions within cells.
- b) Plasma membrane: Forms a protective barrier between the cell inside and outside. Determines cell shape and provides cell stability. Selectively regulates entry and exit of substances.
- c) Nuclear envelope: Separate nuclear contents from cytoplasm hence limits DNA within the nucleoplasm but allows exit of RNA. Controls flow of information to nucleus and DNA that are carried by the macromolecules.
- d) Outer mitochondrial membrane: Allows entry of ATP, NADH and from glycolysis
- e) Inner mitochondrial membrane: Contains electron carriers in electron transport chain
- f) Rough Endoplasmic Reticulum: Intracellular transport and sites for ribosome attachment
- g) Smooth Endoplasmic Reticulum: intracellular transport
- h) Outer chloroplast membrane: Allows photosynthetic products out and substrates in

- i) Thylakoid membranes of chloroplasts: Store photosynthetic pigments e.g. chlorophyll. Contains electron carriers
- j) Golgi complex membrane. Storage of glycoprotein. Synthesis of polysaccharides e.g. cellulose in plants
- k) Lysosomes. Isolates autolytic enzymes from unnecessary digestion of cell components
- l) Tonoplast. Limits cell sap within the vacuole
- m) Membranes surrounding vesicles: Limit the contents of the vesicles within until when ready for exit e.g. calcium ions and neurotransmitters in neurones, undigested materials in phagocytic vesicles, etc.
- n) Neurilemma of neurones. Contains protein pumps for Na⁺ and K⁺ which bring about impulse propagation
- o) Myelin sheath membrane. Insulates nerve fibre to increase transmission speed.

Advantages of having membrane-bound organelles (importance of possession of numerous internal membranes)

1. Internal membranes maintain pH and temperature of internal membranes for reactions to proceed optimally
2. Increases proportion of membrane area to cell volume, increasing surface area over which metabolic reactions occur, for metabolic pathways with membrane-embedded enzymes.
3. Internal membranes partition the cell into compartments, providing different local environments for specific metabolic pathways so that incompatible processes can proceed simultaneously inside the same cell
4. Inner membranes provide attachment sites for specific enzymes, metabolites and molecules, regulating the occurrence of specific metabolic processes.
5. Enzymes and metabolites for particular metabolic pathways are enclosed within organelles, causing close proximity of products of one reaction to the next enzyme in the sequence, thereby increasing the rate of metabolic reactions
6. Internal membranes regulate the entry of metabolites into the organelle, controlling the rate of metabolic activity
7. Potentially harmful metabolites and enzymes are isolated inside organelles, preventing damage to the rest of the cell, such as lytic enzymes in lysosomes.
8. Internal membranes provide a supporting cytoskeleton to the cell, and serve as an intracellular transport system
9. Internal membranes protect the genetic material (DNA) from digestion and chemical alteration, preventing harmful mutations
10. Internal membranes maintain optimal conditions in specific organelles for specific metabolic pathways to proceed optimally

HISTOLOGY

Histology is the study of tissue structure, largely by various methods of staining and microscopy.

A tissue is a group of cells of similar appearance and a common function. Broadly tissues consist of cells physically linked and associated intracellular substances that is specialised for particular function.

There are both plant and animal tissues to be looked at in this study;

HISTOLOGY OF PLANTS

Plant tissues can be divided into;

- a) Meristems, these include apical meristems, lateral meristems and intercalary meristems.
- b) Permanent tissues, which are divided into two major groups;
 - i. Ground tissues, which include;
 - Parenchyma tissues
 - Collenchyma tissue
 - Sclerenchyma tissue
 - ii. Vascular tissues, they include;
 - Xylem
 - Phloem

MERISTEMS

A plant meristem is a group of cells which retain the ability to divide by mitosis. These are three types of meristems namely; apical, lateral & intercalary meristems.

- a) Apical meristems
Are located at the growing shoot and root apex and are responsible for primary growth
- b) Lateral meristems (cambium)
Occur as cylinders into the older parts of the plants are responsible for secondary growth of dicotyledonous plants
- c) Intercalary meristems
These meristems occur at the nodes of the plants

Functions of meristematic cells

Meristematic cells retain the ability to divide by mitosis to produce new cells. The cells elongate and differentiate to form specialised cells to carry out specific functions. Some examples are growth, reproduction and replacement of old and damaged cells.

- i. Apical shoot and root meristems produce new cells for growth of shoot and root
- ii. Vascular cambium produces new cells to increase the diameter of stems and roots during secondary growth
- iii. Cork cambium (phellogen) produces the outer cork layer (phellem) which consists of suberized cells.
The cork layer reduces evaporation of water from the plant and protects against entry of pathogens.
- iv. The intercalary meristems allow growth and increase in length in regions other than the tip

PERMANENT TISSUES

Parenchyma

Parenchyma tissue consist of living cells. They are usually isodiametric or elongated cells. However, their shape may be distorted by pressure from adjacent cells.

Parenchyma cells have thin cell walls containing cellulose, hemicellulose and pectin. There are no secondary walls. The walls are permeable to water and permit the passage of solutes.

The cells have a large central vacuole with a nucleus and a thin layer of cytoplasm pushed to the membrane.

Transverse section of parenchyma cells
(Roberts fig 3.8A page 40 OR Soper fig 6.2a page 169)

Functions of parenchyma tissue

- i. They are unspecialized tissues which form major component of tissue of stems and roots especially in herbaceous plants.
- ii. When the cells are turgid and tightly packed, they provide support for herbaceous plants
- iii. Some parenchyma cells, like mesophyll cells, contain chloroplasts and carry out photosynthesis
- iv. They store food substances such as starch and malic acid that are stored temporarily in the vacuoles of CAM parenchyma cells
- v. The parenchyma cells in flowers and pericarps contain chromoplasts to attract pollinating agents and dispersal agents of seeds and fruits.
- vi. The parenchyma tissues can be modified or differentiated to form specialised cells to carry out specific functions. These include epidermis, mesophyll, endodermis, pericycle, aerenchyma and secretory cells.

Modifications of the parenchyma tissue

Epidermis

This is a layer of flattened cells, one cells thick. The cells secrete cutin which forms a layer of waxy cuticle on the outer surface of the epidermis.

Functions of the epidermis

- i. It's a protective layer to the inner tissue
 - ii. The waxy cuticle reduces water loss through evaporation from the plant and entrance of pathogens
 - iii. Stomatal pores in the epidermis allow gaseous exchange
 - iv. Epidermis is transparent and allows light to reach the mesophyll layers of leaves for photosynthesis.
- **Endodermis**
It consists of a single-celled ring which is a selective barrier between the outer cortex and the inner pericycle tissues.
In roots the endodermis is impregnated with suberin to form a distinct casparian strip and prevent the movement of water via the apoplast pathway. Non-suberized passage cells in the endodermis permit lateral movement of water and mineral salts.

- **Pericycle**
This is made up of one to several layers of parenchyma cells.
Pericycle is found between the endodermis and central vascular tissues. It can divide to produce the lateral roots and it is involved in the secondary growth of roots.
- **Palisade mesophyll**
This is made up of column shaped cells and its found below the upper epidermis.
Function
It contains many chloroplasts that enable a leaf to carry out photosynthesis.
- **Aerenchyma**
Parenchyma tissues that surround large air spaces form reservoirs of oxygen and permit gaseous exchange in submerged parts. The large air spaces also provide buoyancy.
- **Secretory cells**
Some parenchyma tissues are modified to form secretory tissue for example nectary glands, hydathodes and resin ducts.
- **Spongy mesophyll**
It has isodiametric or irregular shaped cells. They are loosely packed with many intracellular space for gaseous exchange. They have fewer chloroplasts than the palisade cells to carry out photosynthesis

Collenchyma

These consist of living cells. Cells are polygonal shaped and they are elongated. They are closely packed together with very small intracellular air spaces.

The cell walls are unevenly thickened at the corners of cell walls (angular collenchyma). Pits are present in the cell walls.

Collenchyma tissues are usually found in herbaceous plants below the epidermis, midrib of the leaves and leaf petioles.

Functions of collenchyma tissues

It acts as a supporting tissue to provide support to herbaceous plants. With mechanical strength and flexibility.

It allows the cell to expand and be stretched as the young stem grows.

Some of the collenchyma cells contain chloroplasts which carry out photosynthesis

Diagram showing a transverse section of collenchyma cells

Soper fig 6.5a page 173

Diagram showing a longitudinal section of the collenchyma cells

(Roberts fig 3.8B page 40 OR Soper fig 6.5b page 173)

Sclerenchyma

They are two types of sclerenchyma

- i. Sclerenchyma fibres
- ii. Sclereids (stone cells)

Diagram showing transverse section through sclerenchyma cells (Soper fig 6.5a page 173)

Sclerenchyma fibres

These are polygonal shaped cells with tapering ends. Mature sclerenchyma cells have thick lignified secondary cell wall impermeable to water, solutes and gases. (Acidified phylorogucinol can be used for staining lignin red). The cells have protoplast with narrow empty lumen. Pits are present in cell walls. Sclerenchyma fibres are found below the epidermis of the stems or roots or around the vascular bundles and in the midrib of the leaves.

Functions

- i. It acts as a supporting tissue. Collectively the tightly packed sclerenchyma fibres with thick lignified walls provide the plant with mechanical strength and rigidity.
- ii. The tapering ends of sclerenchyma fibres overlap and interlock with one another, further increasing their combined strength

Sclereids (stone cells).

They have different shapes but are usually shorter than sclerenchyma fibres. They consist of dead cells with thicker lignified walls. Simple branching pit are present in the walls.

Drawing of the structure of the sclerenchyma sclereids

(Roberts fig 3.8C page 40 OR Soper fig 6.6b page 175)

A simple pit is formed in an area where lignin is not deposited on the primary wall. A bordered pit is formed when lignin arches over the area.

Sclereids are found singly or in groups in stems, leaves, fruits e.g. pears, guavas and in the hard endocarp of coconuts and seeds e.g. testa of beans.

It is a protective tissue which gives strength and support to the plant structures or organs.

Drawing of the structure of a bordered pit (Soper fig 6.12 page 180)

THE VASCULAR TISSUE

Vascular tissue consists of xylem and phloem which are specialised for the internal transport of substances in the plant.

THE XYLEM

The xylem tissue is made up of two conducting tissues or cells known as xylem vessels and xylem tracheids.

(Roberts fig 12.7A page 187 OR Soper fig 6.9B page 77)

A xylem vessel is formed from a chain of elongated cylindrical cells formed end-to-end. The horizontal end-walls break down partially or completely during the course of development to allow open communication between cells. During development of the xylem tissue, the cellulose side walls of this tissue become impregnated or coated with lignin, a very hard layer which makes them impermeable to water, solutes and gases hence leading to the death of the protoplasm of the tissue. This leads to the formation of a hollow tube called xylem vessel hence more water can flow through the hollow continuous tube with less friction.

The lignified walls are perforated by numerous pits which allow horizontal movement of the lumen of water in and out of the lumen of vessels. Most pits are bordered by a lignified rim. In conifers, the bordered pits contain a valve-like plug called **torus** which controls the passage of water through the pits.

Lignification of the side walls (replacing cellulose with lignin) gives the xylem vessel extra mechanical strength, which prevents its walls from curving in or collapsing during the passage of water under a high tension. This lignification of the side walls occurs in four different patterns which include, annular lignification, simple spiral lignification, multi spiral lignification and reticular lignification

The protoxylem is the first xylem vessel to develop, just behind the apical meristem in the shoot and root. There is incomplete lignification in the walls of protoxylem vessels. Lignin is deposited in rings to form annular vessels in spirals to form spiral vessels. These annular and spiral vessels can be stretched to provide support for vessels during elongated and growth of the young stems and roots.

Different types of thickenings

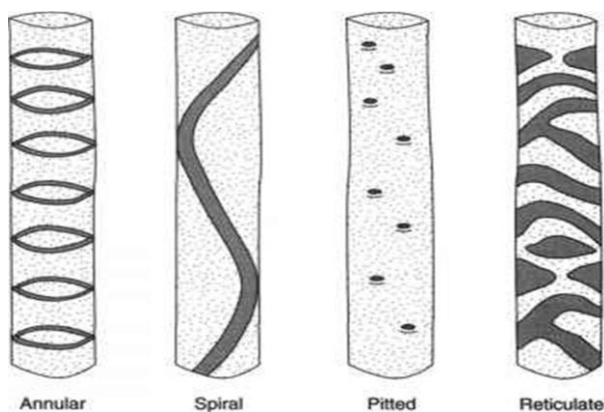

As growth proceeds, new vessels are formed with more extensive lignification, these are called metaxylem. Metaxylem have bigger lumen and are able to transport more water and mineral ions to the older plant. The presence of pits in the metaxylem vessels allow lateral movement of water and mineral ions to the surrounding living cells (from one tracheid to another). Secondary xylem is formed from the activity of the vascular cambium of dicotyledonous plants during secondary growth.

Although the vessels and tracheids of the xylem tissues are meant for transportation of mineral salts from roots to leaves. They also provide mechanical strength and greatly offer support to the plant.

The table below shows a comparison between the xylem and the tracheids.

Similarities	Differences	
	Xylem vessels	Tracheids
	Cylindrical shape	Are 5 to 6 sided in cross section
	Have open ends at their sides	Perforated end walls
	Have non tapering (pointed) ends	Have tapering ends
	Offers less resistance towards water passage	Offer more resistance towards water passage

Adaptations of the xylem tissue for water transport

1. Xylem vessels have a narrow lumen which enables the upward movement of water from roots to leaves due to the high capillarity
2. Xylem vessels and tracheids have lignified cell walls which enable upward movement of water through them at a high tension as lignin prevents curving in of the walls due its tensile strength and it makes the xylem water proof.
3. Xylem vessels and tracheids lack living protoplasmic contents which enable them to remain hollow so that they allow water to move through with minimum resistance.
4. Xylem vessels and tracheids have partially or completely broken down to allow open communication of one cell to another such that there's free passage of water through them.
5. Xylem vessels and tracheids side walls are perforated by lateral pits to allow horizontal movement of water in and out of the xylem tubes.
6. In some plants like conifers, the bordered pits of the tracheids have a plug-like torus which controls the lateral passage of water through the pits
7. In the protoxylem, annular and spiral thickenings allow the stretching of the walls and further elongation of the stem is possible. In the metaxylem, scalariform, reticulate and pitted thickenings provide additional mechanical strength to older stems. Metaxylem vessels have bigger lumens than protoxylem to transport more water.

Roberts fig 12.7b page 187

THE PHLOEM

The phloem tissue consists of sieve tube elements, companion cells, parenchyma cells, fibres and sclereids.

Translocation of organic food molecules from the leaves where they are manufactured takes place through sieve tubes of the phloem. The sieve tubes are long tubes formed from the fusion of end to end sieve tube elements, where end walls break down to a greater or lesser extent to allow the passage of materials.

Roberts fig 12.5A page 293

Sieve tube elements are mature sieve tubes without a nucleus. When still young, the sieve tube cells contain a nucleus and other organelles such as ribosomes, mitochondria, endoplasmic reticulum e.t.c.

At maturity, the cell organelles of the sieve tube elements including the nucleus degenerate, though some few such as the mitochondria, plastids, endoplasmic reticulum e.t.c persist immediately adjacent to the cell walls only.

During differentiation i.e. specialisation for a particular function, the end walls of the adjacent sieve tube elements get coated with cellulose, and form a sieve plate that is perforated by sieve pores. Through the sieve pores are cytoplasmic filaments or trans-cellular strands which run across and are continuous with all the sieve tube elements in the tissue. The cytoplasm of these trans-cellular strands is structurally very simple without organelles because all the organelles degenerate during its development. The side walls of the sieve tube elements are impregnated or coated with a lot of cellulose and pectic acid.

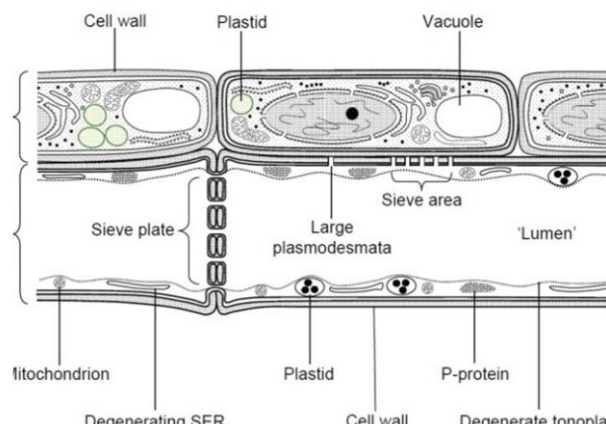

Alongside each sieve tube element is one or more companion cells made of thin cellulose walls, enclosing a protoplast with a dense cytoplasm. The companion cells are the metabolically active cells of this tissue with a prominent nucleus, numerous mitochondria, ribosomes and many other organelles. Therefore most important processes which involve active metabolism are conducted within the companion cells and all the required materials for these processes and all the required materials for these processes are passed via plasmodesmata from the companion cells or to the sieve tube elements and vice versa. The sieve tube elements are therefore living cells.

Adaptations of the phloem tissues for its function

1. It has sieve plates which are perforated to enable a continuous of food
2. The sieve tubes have large pits (plasmodesmata) for lateral movement of organic substances.
3. Companion cells have numerous mitochondria so as to produce large quantities of energy in form of ATP needed for transport of food.

4. Sieve tube elements have fewer cell organelles so as to provide more space for the flow of food materials
5. Some sieve tube elements have cytoplasmic strands or filaments (trans-cellular strands) which allow peristaltic movement of food through the sieve tubes

Phloem collenchyma cells have thick cellulose fibres for providing mechanical support to avoid collapse.

HISTOLOGY OF ANIMALS

Animals are multicellular and they need to have a combination of the individual cells so as to form tissues. This enables the animal to function properly. Animals have a small surface area to volume ratio as compared to unicellular organisms. Therefore, simple processes of diffusion, osmotic uptake of molecules, phagocytosis e.t.c. are not adequate in their function and therefore, there's need for the cells to combine together to form tissues and even in the complex animals, tissues form organs so as to carry out the various functions over a surface with a small surface area to volume ratio.

Animal tissues fall into four main categories;

- | | |
|-----------------------|--------------------|
| 1. Epithelial tissues | 3. Muscle tissues |
| 2. Connective tissues | 4. Nervous tissues |

EPITHELIAL TISSUE

This is the tissue found lining the free surface of animal internally and externally. If the tissue is internal, then it's called an endothelium. The endothelium is found lining all the internal body cavities and lumen. Such activities include the mouth lining, trachea, blood vessels, tubules, oviducts e.t.c.

Epithelial cells are attached to the underlying tissue by a basement membrane, made of a network of white wavy, non-elastic collagen fibres.

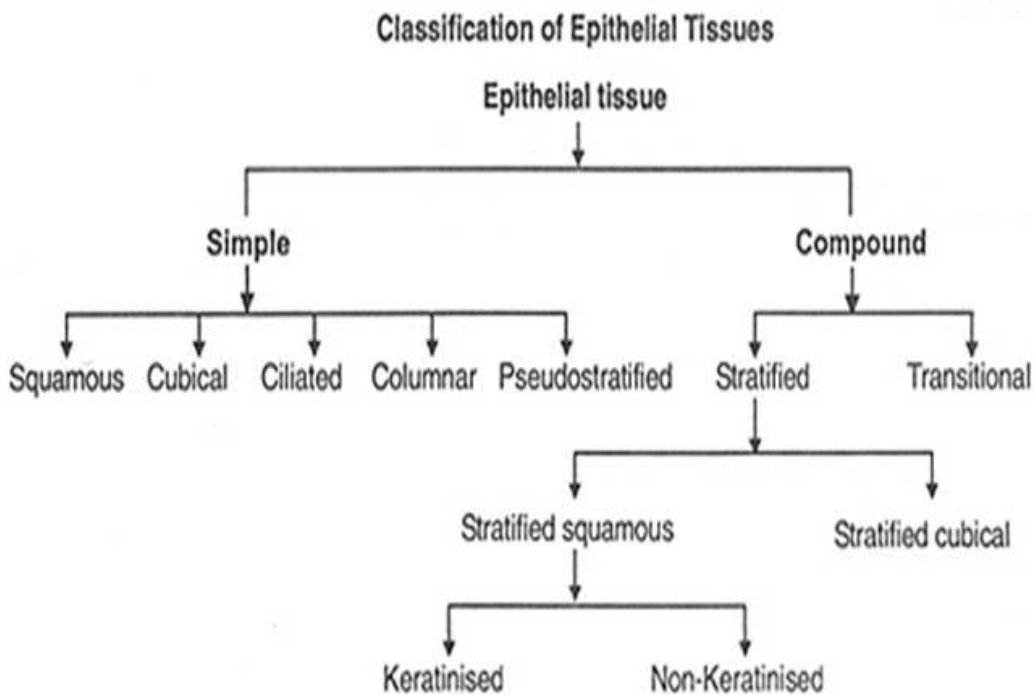

Epithelial tissues are mainly protective and secretory. However, they are of a variety of forms and differ in shape and number of layers and may perform different functions e.g. in the

- a. skin they are protective
- b. lungs they are respiratory
- c. gut they are secretory
- d. kidney they are excretory
- e. tongue they are sensory
- f. gonads they are reproductive where they form the germinal epithelium

Characteristics of epithelial tissue cells

- a. they are attached to the basement membrane which is produced by the cells themselves
- b. the adjacent cells are joined by intracellular cement
- c. there may be interconnecting bridges of cytoplasm within cells
- d. they undergo rapid cell division to resist wearing away (abrasion)
- e. they may build up large numbers of layers to resist wearing away e.g. in the epidermis of the skin

Epithelial tissues are classified according to the number of cell layers and the shape of the individual cells in longitudinal section. They are usually classified into two categories;

- a. **Simple epithelium**, this is usually one cell thick. It includes;
 - i. Squamous epithelium
 - ii. Columnar epithelium
 - iii. Ciliated epithelium
 - iv. Cuboidal epithelium
 - v. Pseudostratified epithelium

Simple squamous epithelium

This is the simplest type of epithelial tissue, sometimes called the *pavement epithelium*. It has the following characteristics;

**Surface view (Roberts fig 3.1
page 33)**

- The cells are very thin and contain little cytoplasm
- It consists of delicate cells usually less than 20mm thick.
- The cells are loosely packed
- The nucleus is centrally placed
- The cells are flat in nature and fixed on a basement membrane.
- They have little intercellular substance (matrix) in which the cells are embedded.

The above characteristics enable the epithelium to perform the following functions;

- i. In the lumen or blood vessels, the tissue offers a smooth surface for the efficient passage of fluids.
- ii. In the Bowman's capsule and glomerulus, the tissue is permeable to fluids and there's quick diffusion of the fluids
- iii. Between the two surfaces that slide over each e.g. between the ribs, the epithelium reduces friction

Simple columnar epithelium

The characteristics of the columnar epithelium include;

- Cells which are found at right angles to the basement membrane.
- The cells are tall and narrow in shape (elongated with a length much more than the width)
- The nuclei of the cells are at the base of the cells

- Sometimes the cells have microvilli at their end and this makes the cells have a striated or divided border
- The cells may at times have the mucus secreting cells (goblet cells) interspersed among them and the tissue is known as glandular columnar epithelium.
- The micro villi increase the surface area of the cells which are in contact with the fluids
- The goblet cells produce mucus for the reducing friction and for protection against digestive enzymes

The columnar epithelium offers an extensive surface area and it is often found where there's absorption of materials in the form of gases and solutions e.g. lining the small intestines and stomach.

It is a component of the gall bladder and thyroid gland and it protects many kidney ducts.

<p style="text-align: center;">Longitudinal view</p> <p>Soper fig 6.16a page 185 OR Roberts fig 3.1 page 33</p>	<p style="text-align: center;">Diagram of a goblet cell</p> <p>Soper fig 6.17 page 185</p>
--	---

Simple ciliated Columnar epithelium

The cells of the tissue have the same characteristic as those of the columnar epithelium except that they have cilia instead of the micro villi and are associated with mucus secreting goblet cells.

The ciliated epithelium is found;

- i. Lining cavities in charge of movement or those of in charge of tiny particles.
- ii. In the respiratory tract (trachea) where dust particles are trapped by mucus and then waffled or moved by cilia into the pharynx.
- iii. In the oviduct where they transport the ova
- iv. In the brain cavities and the spinal cord where they keep the fluids in motion

Longitudinal section

Roberts fig 3.1 page 33 OR Soper fig 6.17a page **185**

Simple cuboidal epithelium

Longitudinal view

Roberts fig 3.1 page 33 OR Soper fig 6.15 page **184**

This is the least specialised of all epithelia.

- The cells are cuboid in shape
- The nucleus is usually centrally positioned
- Some cells may have microvilli in the surface to increase surface area

Such cells perform the following functions;

- i. Excretion of waste products in the human kidney i.e. lining the Loop of Henle and collecting duct

- ii. It is also found in the salivary glands, sweat glands, collecting duct of the pancreas, mucus glands, germinal epithelium of the ovary and the thyroid gland

NOTE: such epithelia is located in areas where there's secretion of fluids

Pseudo-stratified epithelium

Longitudinal view

Stratified means layers. This epithelium has the following characteristics;

Soper fig 6.18a page **186**

- Its cells don't reach the free surface uniformly
- The cells are of unequal size
- The nuclei of the epithelium appear at different levels
- The cells are usually columnar in shape and ciliated

This type of epithelia is found lining the cavities e.g. the urinary bladder and nasal passages.

b. **Compound epithelium**, this is more than one cell thick. They include;

- i. Transitional epithelium
- ii. Stratified epithelium
- iii. Glandular epithelium

Transitional epithelium

It consists of three to four layers of cells thick. Its cells can alter or change shape when put under pressure i.e. they are intermediate between stratified and cuboidal (when relaxed) and stratified squamous (when contracted or stretched)

This type of epithelium is found lining/covering organs that constantly experience pressure and distensions e.g. in the urinary bladder, ureter and in the pelvic region of the kidney.

Drawing of longitudinal view

Note: epithelial cells are frequently interspaced with secretory cells and in this case they form a glandular epithelium which secrete materials like mucus, hormones, enzymes into cavities, spaces which it is lining

Stratified epithelium

It has got layers/strata of cells with only one layer resting on the basement membrane. The cells continue to divide by mitosis and push other layers of cells outwards which look thin and flattened. The epithelium is very thick, consisting of more than four layers of cells.

Roberts fig 3.1 page 33 OR Soper fig 6.19a page **186**

In some stratified epithelium, the outer most cells (squamous) may be transformed into a dead horny layer of keratin and in this case the epithelium is said to be cornified which makes it tough and impervious to water and gases.

Its superficial/surface cells wear off from the surface while new cells are regenerated from the basement membrane.

This type of epithelia is found covering regions/surfaces that are exposed to constant wear and tear. It's the thickest and toughest regions that experience friction most often, such regions include the sides of the feet and palms, outer skin, linings of the oesophagus, anus and vagina.

Note: stratified cuboidal epithelium consists of more than one layer of cuboidal cells and it is found lining the excretory ducts of exocrine glands such as salivary glands, sweat glands and the pancreas.

Glandular epithelium

Roberts fig 3.1 page 33

Glandular cells are secretory in function. They produce secretions such as sweat by the sweat glands, sebum by the sebaceous glands, tears by the tear glands e.t.c.

Glandular epithelia can exist in two ways i.e. the epithelia can bear a single layer of cells or it can bear an aggregate or group of glandular cells in one place forming a multicellular gland

An example of a single glandular epithelia is the goblet gland. If the gland discharges its secretions into a duct, then it is described as an exocrine gland e.g. the pancreas. If there's no duct in the gland, so that the secretions are discharged directly into the blood stream, then it is called an endocrine gland (ductless gland). Most hormone producing glands are endocrine glands while those producing enzymes and secretions are exocrine glands.

NOTE; the pancreas and the stomach are both exocrine and endocrine.

Diagrams showing formation of endocrine and exocrine glands

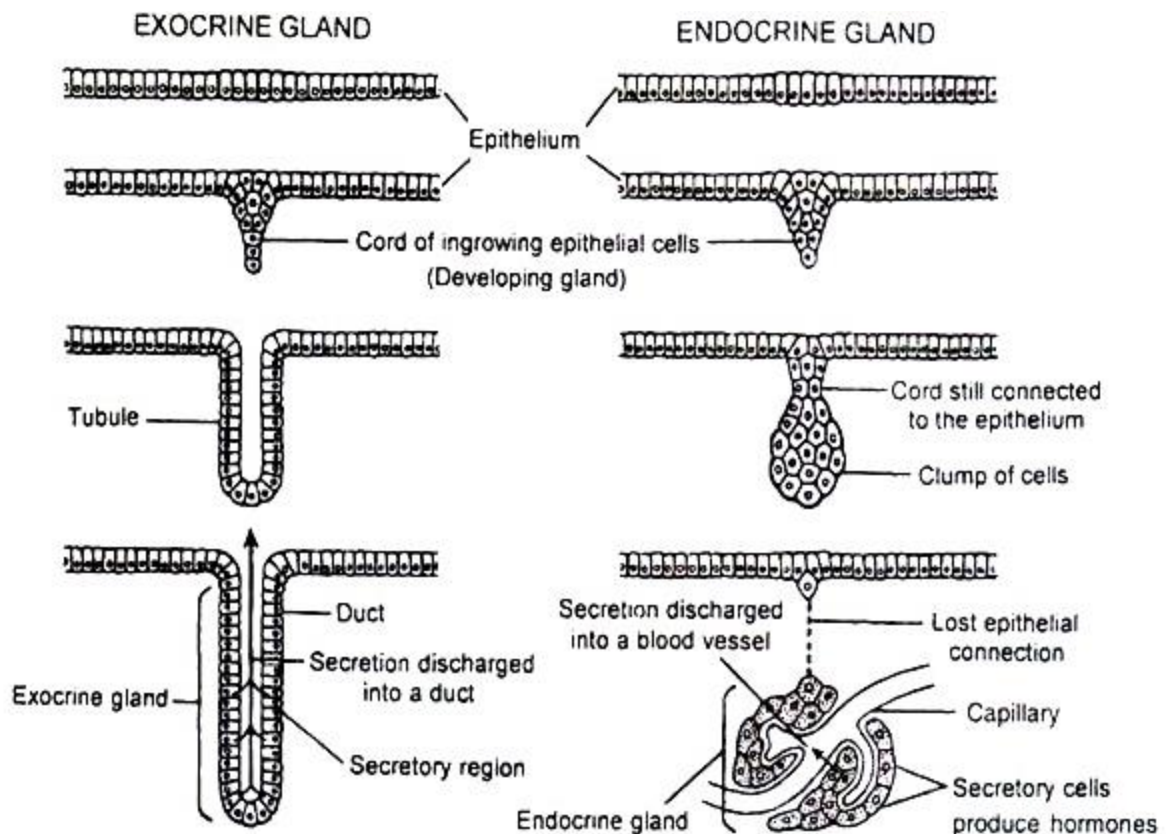

Secretions produced by glandular cells are released in three different ways;

a) Merocrine

In **merocrine** glands, the secretions produced in cells are passed through the cell membrane at the cell's surface and there is no loss of cytoplasm. This occurs in the simple goblet cells, sweat glands and vertebrate pancreas.

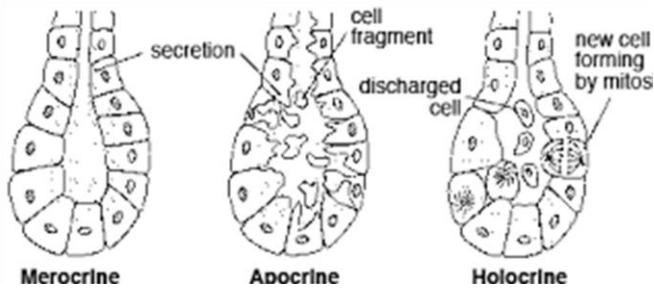

b) Apocrine

In **apocrine** glands, the portion of cell's distal cytoplasm is lost as the secretion is lost e.g. in the secretion of the mammary glands.

c) Holocrine

In **holocrine**, the cell(s) breaks down to release its secretions (secretory products) and the cell is excluded from the epithelial layer e.g. in the sebaceous glands which produce sebum for the softness of hair.

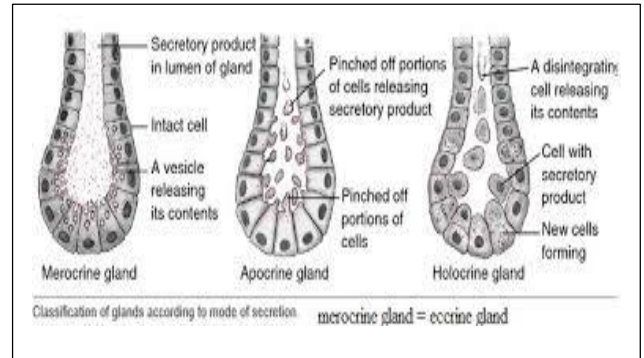

Sometimes a cell may secrete different materials each by a different method e.g. in a mammary glands, the lipid is secreted by apocrine mechanism and the protein secretion is by merocrine or mucocyte. If the secretion produced is clear/watery and contains enzymes, the gland is called a serocyte. If both secretions are produced from within the same glands, then it is called a mixed gland.

Certain glandular epithelia contain so many densely packed secretory cells that are folded in various ways to increase the surface area from which secretions takes place. Folding of glandular epithelia results in the formation of glands whose sole function secretion. The different types of exocrine glands include;

Glandular epithelia can exist in two ways i.e. the epithelia can bear a single layer of cells or it can bear an aggregate or group of glandular cells in one place forming a multicellular gland. An example of a single glandular epithelia is the goblet gland. If the gland discharges its secretions into a duct, then it is described as an exocrine gland e.g. the pancreas. If there's no duct in the gland, so that the secretions are discharged directly into the blood stream, then it is called an endocrine gland (ductless gland). Most hormone producing glands are endocrine glands while those producing enzymes and secretions are exocrine glands.

NOTE; the pancreas and the stomach are both exocrine and endocrine.

Certain glandular epithelia contain so many densely packed secretory cells that are folded in various ways to increase the surface area from which secretions takes place. Folding of glandular epithelia results in the formation of glands whose sole function secretion using either tube-shaped or sac-shaped portions of the epithelia for secretion. The different types of exocrine glands include;

Simple tubular gland e.g. crypts of Lieberkühn in the ileum and the fundic regions of the stomach

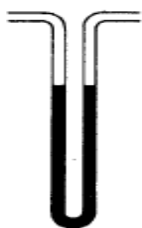

Simple saccular gland e.g. mucus glands in the skin of the frog and other amphibians



Simple branched tubular gland e.g. Brunner's gland and gastric glands



Coiled tubular gland e.g. the sweat gland in the skin of man



Compound tubular gland
e.g. salivary glands

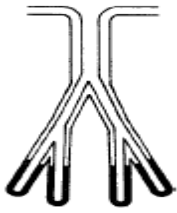

Simple branched saccular gland e.g. the oil-secreting sebaceous glands in mammalian skin



Compound tubulosaccular e.g. salivary glands



Compound saccular gland e.g. mammary glands and the part of the pancreas which secrete digestive enzymes

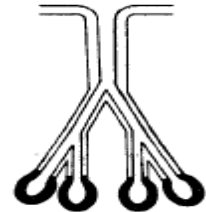

The secretory portions are black

CONNECTIVE TISSUE

These are tissues which bind other tissues together e.g. in the muscles. They include the adipose (fat) tissue, collagen tissue, and skeletal tissue which is composed of bones and cartilage. They bind or support other tissues of the body.

Main characteristics of connective tissue

- They possess a considerable number of fibres in the intercellular substances
- They have a large amount of intercellular substances
- They are all developed from the mesoderm

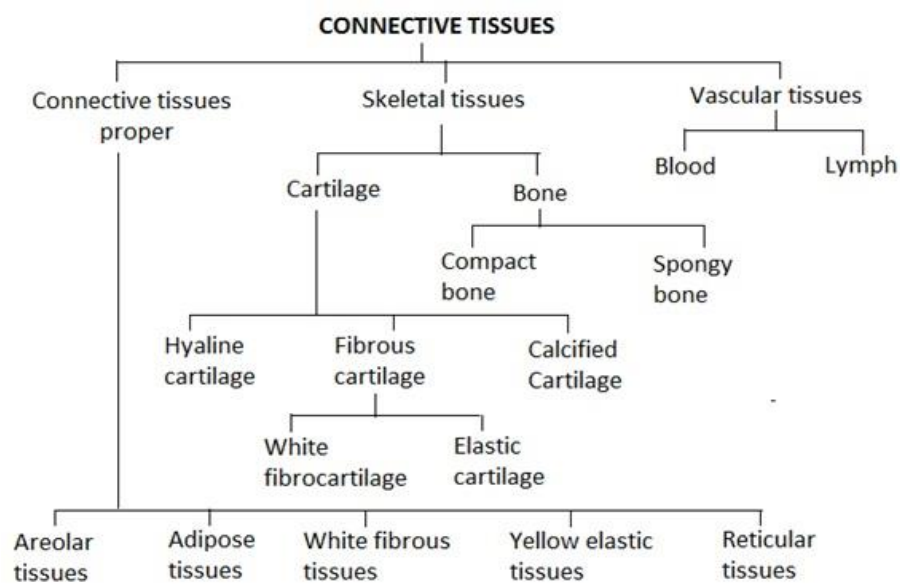

AREOLAR TISSUE

This tissue contains cells which are widely dispersed in the matrix and has fibres that are loosely woven in a random manner. The matrix is a transparent semi-fluid which consists of gelatinous glycoproteins containing many types of cells and protein fibres. The fluid also contains abundant mucin, hyalorinic acid and chondroitic sulphate.

The areolar tissue is strong and tough due to two types of fibres i.e.

- a) The unbranched collagen (white) fibres which run parallel to each other in a bundle
- b) The branched elastic (yellow) fibres which form a dense network in the matrix

The cells of the areolar tissue include;

- i. Cells responsible for synthesis and maintenance of extracellular material e.g. the **fibroblasts** which secrete both collagen and elastic fibres and are usually associated with the fibres they secrete
- ii. Cells responsible for storage and metabolism of fats e.g. the **fat cells**
- iii. Cells which defend and have immune functions e.g. phagocytes/phagocytic **macrophages**
- iv. Amoeboid **mast cells** which are oval shaped and they secrete a matrix and anticoagulants such as heparin and histamine
- v. Plasma cells which produce antibodies that are important components in the body's immune system
- vi. **Chromatophores** which are present in some specialised areas of the skin and eye. The cells are densely packed with melanin which gives the skin its characteristic colour and in the retina of the eye they prevent back reflection of light
- vii. Mesenchyme cells which act as reservoirs of undifferentiated cells in the tissue. They can be stimulated to transform into any one of the above cells when need arises.

Structure of areolar connective tissue
(Roberts fig 3.5 page 36)

THE COLLAGEN (white fibrous) TISSUE

This consists of glycoprotein matrix which contains mainly densely packed collage fibres. Each collagen strand has three chains of *tropocollagen* plaited together as in a rope. The tissue is comparatively inelastic and has great tensile strength. They are located in areas with great tension such as tendons, sclerotic and cornea of the eye, the kidney capsule, in some ligaments and in the perichondrium.

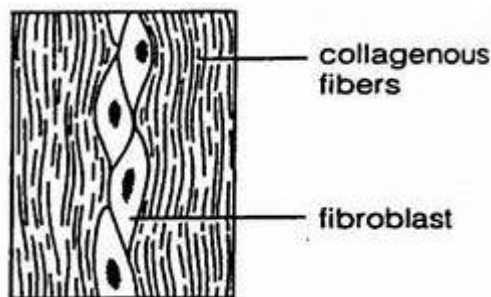

ELASTIC TISSUES (yellow elastic tissue)

This consists of glycoprotein matrix containing only elastic fibres and they combine strength with elasticity.

They are found in ligaments, walls of arteries, lungs and in the neck chords.

ADIPOSE TISSUE (fatty tissue)

The matric contains densely packed fat cells. The tissue is important in storage and in the skin it insulates the body against heat loss.

They are found around the heart and kidney and act as energy reservoirs and shock absorbers.

SKELETAL TISSUES

The vertebrate skeletal tissue is composed of **cartilage only** like in elasmobranch fishes e.g. dogfish and sharks or **both cartilage and bone** covered by a muscular system. It also includes **ligaments and tendons**. Bones form the larger component of the skeleton and cartilage is only found at joints. Ligaments connect bones together and fit them in position while tendons connect muscles to bones. All skeletal tissues consist of living cells surrounded by a non-living matrix secreted by the cells themselves.

FEATURES OF CARTILAGE

It consists of a firm translucent matrix of muco-polysaccharide called **chondrin**. The matrix is produced by cells called **chondroblasts** which are distributed in the matrix in groups of single pairs or fours.

The cartilage is surrounded by a connective tissue made up of a dense network of fibres and cells called **perichondrion** from where new chondroblasts are produced.

Cartilage is non vascularised i.e. not supplied with blood and therefore materials and nutrients diffuse in and out via the matrix.

Each chondroblast occupy its own space called **lacuna** and this chondroblast enclosed in a lacuna is referred to as a **chondrocyte**.

The matrix may be impregnated with collagen as in the vertebral disc and elastic fibres as in the ear and the nose

Cartilage tissue is of three types; **Hyaline, Yellow / elastic** and **White/ fibro-cartilage**.

Hyaline cartilage

It's the most common type of cartilage, its matrix is translucent and contains very fine collagenous fibres.

Location: nose, ends of long bones, ribs, trachea rings, foetal skeleton.

- It's a solid flexible connective tissue composed of a translucent mucopolysaccharide matrix (chondrin) in which are distributed cartilage cells (chondroblasts) and many intercellular substances like fibres.
- Each chondroblast lies in a small chamber called lacuna surrounding by a capsule.
- Chondrin lacks direct blood supply except in the Perichondrium; a tough fibrous membrane surrounding cartilage.
- In some cases chondroblasts occur in cell nests i.e. a pair or 2 pairs of cells encased by one capsule.

NB: Chondroblasts that become embedded in the matrix are called chondrocytes.

Roberts, et.al Adv. Biol. Pg. 67 fig. 4.9

Yellow / elastic cartilage

It's more flexible than hyaline cartilage because the matrix contains many elastic fibres in addition to collagen fibres.

Location: frame work of Pinna (outer ear), epiglottis.

White / fibro-cartilage

Contains dense collagenous fibres embedded in matrix, it absorbs shock and reduces friction between joints and can withstand tension and pressure.

Location: intervertebral discs, wedges in the knee joint, insertion of tendon on patella.

THE MAIN FUNCTIONS OF CARTILAGE TISSUE

Reducing friction at the joints; supporting tracheal and bronchial tubes; acting as shock absorbers between vertebrae; maintaining the shape and flexibility of ear and nose.

Main features of bone tissue

- It's a rigid, tough, connective tissue composed mainly of calcified substance.
- Bones occur in a variety of shapes, have complex internal and external structures, are lightweight yet strong.

●Several tissue types make up bone; including the mineralized bone tissue that gives it rigidity and brittleness, collagen fibres that provide slight elasticity, marrow, endosteum, periosteum, nerves, blood vessels and cartilage.

●All bones consist of living and dead cells embedded in the mineralized organic matrix called osteon that makes up the bone tissue.

Description of bone structure

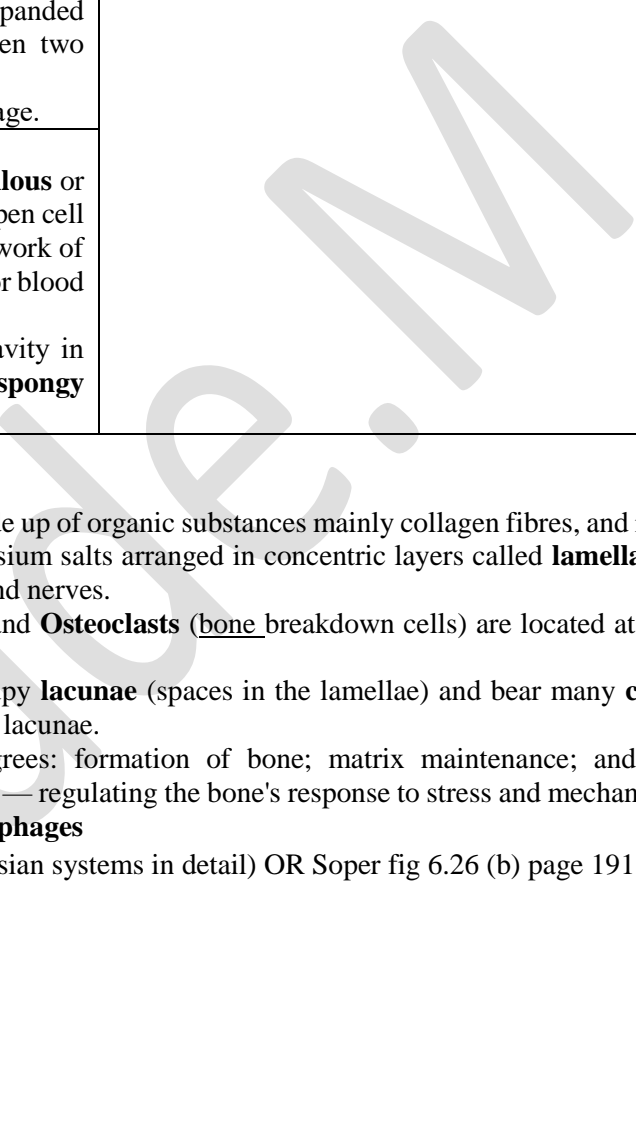
<p>External structure</p> <ul style="list-style-type: none"> ●A tough, fibrous, vascularised connective tissue called periosteum encloses a compact outer layer. ●The epiphyses (ends of bone) are usually expanded while the diaphysis / shaft (portion between two epiphyses) is slightly narrow. ●Each epiphysis is covered by articular cartilage. 	<p><i>Draw from: Soper (VS of femur head)</i></p> 
<p>Internal structure</p> <ul style="list-style-type: none"> ● Filling the interior of the bone is the cancellous or spongy bone or trabecular bone tissue (an open cell porous network), which is composed of a network of rod- and plate-like elements that make room for blood vessels and marrow. ●Fatty yellow marrow fills the medullary cavity in the diaphysis while red marrow occurs in the spongy bone at the epiphyses. 	

Molecular and Cellular structure

● Bone matrix (**osteon**) of compact bone is made up of organic substances mainly collagen fibres, and inorganic materials like calcium, phosphorus and magnesium salts arranged in concentric layers called **lamellae** around **Haversian canals** that contain blood vessels and nerves.

●**Osteoblasts** (immature bone forming cells) and **Osteoclasts** (bone breakdown cells) are located at the bone surface.

●Osteocytes (mature bone forming cells) occupy **lacunae** (spaces in the lamellae) and bear many **canaliculi** (fine protoplasmic extensions) that span across lacunae.

Osteocyte functions include, to varying degrees: formation of bone; matrix maintenance; and calcium homeostasis, act as mechano-sensory receptors — regulating the bone's response to stress and mechanical load.

NB: Osteoclasts are closely related to macrophages

Draw from: Roberts, Pg. 68 fig. 4.10 D (Haversian systems in detail) OR Soper fig 6.26 (b) page 191

HOW STRUTURE IS RELATED TO FUNCTION IN COMPACT BONE

- Bone matrix (**osteon**) is made up of organic substances mainly collagen fibres, and inorganic materials which provide great tensile strength.
- There is continual remodeling which enables compact bone to respond to mechanical stress of varying loads placed on it.
- **Haversian canals** contain blood vessels for efficient supply of nutrients to and draining of wastes from bone cells.
- Osteocytes (mature bone forming cells) bear many **canaliculi** (fine protoplasmic extensions) that span across lacunae to improve on material exchange between the bone cells.
- Bundles of collagen fibres originate from the bone surface and act as a firm base for tendon insertions.

MAIN FUNCTIONS OF BONES

A. Mechanical

- They protect internal organs, e.g. the skull protects the brain, the rib cage protects the heart and lungs
- They provide a frame work to keep the body supported.
- Bones, skeletal muscles, tendons, ligaments and joints function together to generate and transfer forces to cause movement.
- Bones in the ear (ossicles) transmit vibrations that result in hearing.

B. Synthetic

- Bone marrow, located within the medullary cavity of long bones and interstices of cancellous bone, produces blood cells in a process called haematopoiesis.

C. Metabolic

- Bones act as reserves of minerals important for the body, most notably calcium and phosphorus.
- Mineralized bone matrix stores important growth factors such as insulin-like growth factors, transforming growth factor, etc.
- The yellow bone marrow acts as a storage reserve of fatty acids.
- Bone buffers the blood against excessive pH changes by absorbing or releasing alkaline salts.
- Bone tissues can also store heavy metals and other foreign elements, removing them from the blood and reducing their effects on other tissues. These can later be gradually released for excretion
- Bone controls phosphate metabolism by releasing fibroblast growth factor – 23, which acts on kidneys to reduce phosphate reabsorption. Bone cells also release a hormone called osteocalcin, which contributes to the regulation of blood glucose and fat deposition. Osteocalcin increases both the insulin secretion and sensitivity, in addition to boosting the number of insulin-producing cells and reducing stores of fat

COMPARISON OF BONE AND CARTILAGE

Similarities

- Both bone and cartilage consist of living cells and extracellular matrix
- Cells reside in lacunae in both.
- Both are capable of growth.
- Both have collagen fibres

Differences

CHARACTERISTIC	CARTILAGE	BONE
<i>Mechanical properties</i>	● Stiff but flexible and incompressible	● Rigid and brittle.

Innervation	<ul style="list-style-type: none"> ●Lacks nerve stimulation 	<ul style="list-style-type: none"> ●Has nerve fibers
External covering	<ul style="list-style-type: none"> ●Covered by perichondrium 	<ul style="list-style-type: none"> ●Covered by periosteum
Nature of growth	<ul style="list-style-type: none"> ●There is both appositional growth (addition of new cells and matrix onto the outside of the growing structure) and interstitial growth (cell division and secretion of new matrix within an established structure). ●Mature cartilage is relatively permanent. 	<ul style="list-style-type: none"> ●There is only appositional growth (addition of new cells and matrix onto the outside of the growing structure) ● Internal <u>remodelling</u> (continual destruction and renewal) occurs throughout life.
Internal anatomy	<ul style="list-style-type: none"> ●Cartilage is compact, no marrow ● Occurs in 3 forms; hyaline, fibro-cartilage and elastic cartilage. ●No lamellae, no Haversian canals. ●No Haversian systems. ●Matrix is gel-like and non-calcified ● Chondrocytes are spherically-shaped. ● Avascular (no blood vessels). ● Matrix allows tissue fluid diffusion. 	<ul style="list-style-type: none"> ● Most mature bones have a marrow-filled cavity. ●Occurs in 2 forms; compact and spongy bone. ●Organic and inorganic substances are arranged in concentric layers called lamellae around Haversian canals ●Compact bone has lamellae organized into sets of Haversian systems. ● Matrix is highly calcified. ●Osteocytes bear canaliculi (fine protoplasmic extensions). ● Vascular (has blood vessels). ● Matrix impermeable to tissue fluid diffusion.

SAMPLE QUESTIONS

1. Figure one below shows the structure of the plasma membrane

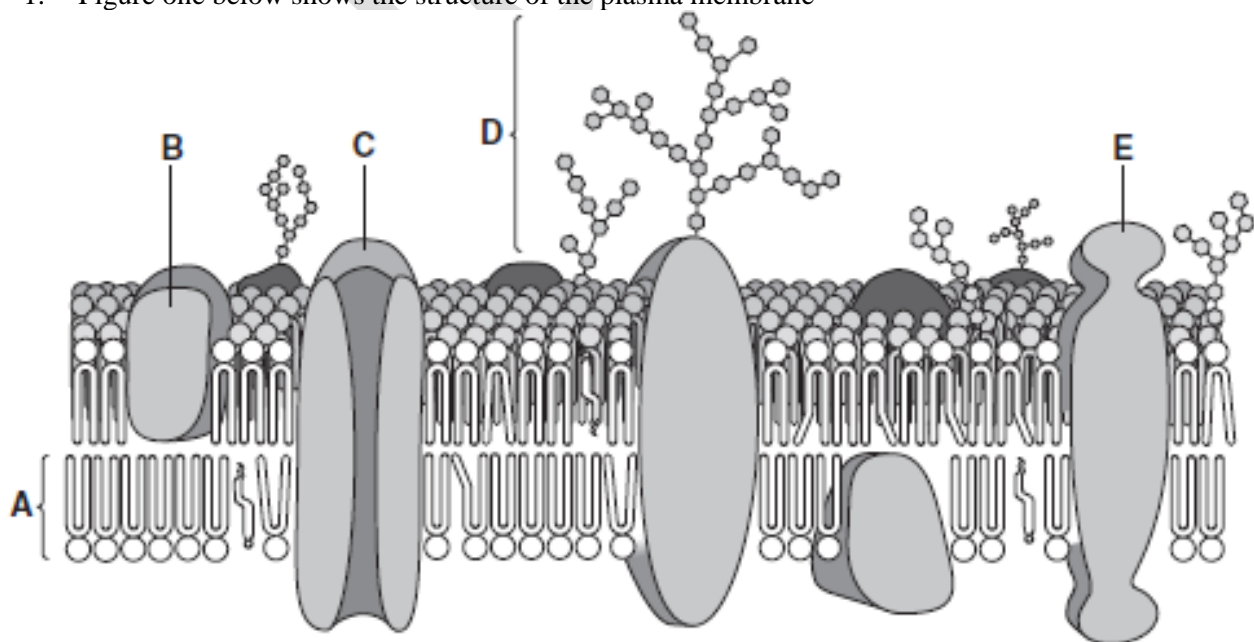

(a) Name molecules **A, B and E**

(03 marks)

(b) Explain how the features of **molecules of A** cause them to form a layer in the membrane as seen in the figure above (03 marks)

(c) State the functions of **C** and **D** (02 marks)

2. a) State the **physiological importance** of the following structural components of the plasma membrane.

i. Proteins (03 marks)

ii. Carbohydrates (02 marks)

iii. Cholesterol (03 marks)

b) Explain why non polar (lipid soluble) molecules diffuse more rapidly through membranes than polar (lipid insoluble) molecules. (02 marks)

3. (a) Describe the formation of Golgi bodies in the cell (06 marks)

(b) What are the functions of this organelle to the cell? (04 marks)

4. a) State the components of the **cell theory**? (04 marks)

(b) The figure below shows part of a membrane

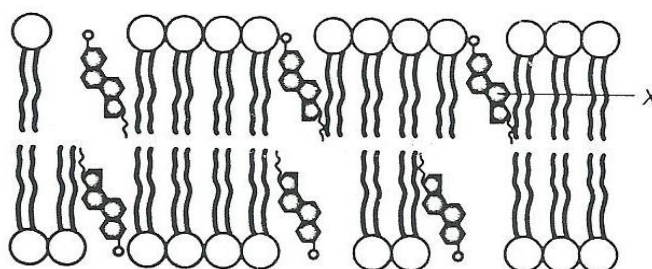

(i) Name the structure labelled **X** (01 mark)

(ii) Explain briefly the role of **X** in the membrane when the surrounding temperature is low or at moderately warm conditions (05 marks)

5. Mitochondria and chloroplasts are cell organelles that change energy from one form to another

a) What is meant by the term cell **organelle**? (02 marks)

b) Describe how the **membranes** of the two enable them to carry out their respective functions

i. Mitochondria (03 marks)

ii. Chloroplasts (03 marks)

6. The diagram below is drawn from an electron micrograph and shows the structure of parts of a cell and the barrier between it and two of its neighbours.

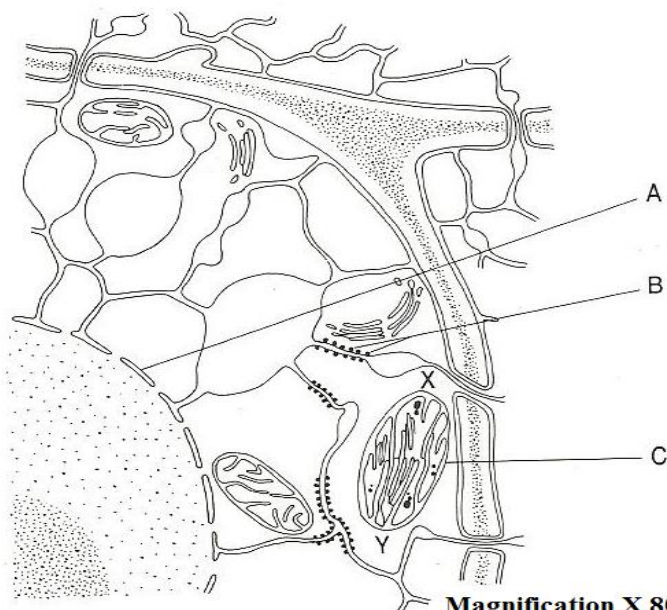

Magnification X 8000

- (a) (i) Identify the structures **A** and **B** (02 marks)
 (ii) What role do structures **A** and **B** play in the life of the cell?
 (b) Give **two** features of the cell which show that it is **NOT** a prokaryotic cell (02 marks)
 (c) (i) Is it a plant cell or animal cell? (1 mark)
 (ii) Give **two** reasons for your identification in (c) (i) above (2 marks)

Measure the length **XY** of the organelle **C** and calculate the actual length in μm . Show your working.
 (2mks)

7. (a) Give three properties of the cell membrane (03 marks)
 (b) Name two other membranes in the cell with similar properties as the cell membrane
 (c) (i) What is the name given to membrane bound cell inclusions (01 marks)
 (ii) What purpose is served by membranes in such cell inclusions? (02 marks)
 (d) (i) What constitutes the cell's protoplast? (01 marks)
 (ii) List three processes carried out by the cell's protoplast? (03 marks)
8. a) State the physiological importance of the following structural components of the plasma membrane.
 i. Proteins (03 marks)
 ii. Carbohydrates (02 marks)
 iii. Cholesterol (03 marks)
 b) Explain why non polar (lipid soluble) molecules diffuse more rapidly through membranes than polar (lipid insoluble) molecules. (02 marks)
9. (a) Briefly describe the structure of the mitochondrion, without drawing (04 marks)
 (b) How are mitochondria suited for their functions? (02 marks)
 (c) State two structural differences between mitochondria and chloroplasts (02 marks)
 (d) Mitochondria and chloroplasts are said to be semi-autonomous. Explain this statement. (02 marks)
10. (a) Distinguish between prokaryotic and eukaryotic cells (01 mark)
 (b) State eight (8) structural and two (2) functional major differences between prokaryotic and eukaryotic cells.
 (i) Structural differences (08 marks)
 (ii) Functional differences (02 marks)

11. The diagram below shows the structure of the cell surface membrane of an animal cell

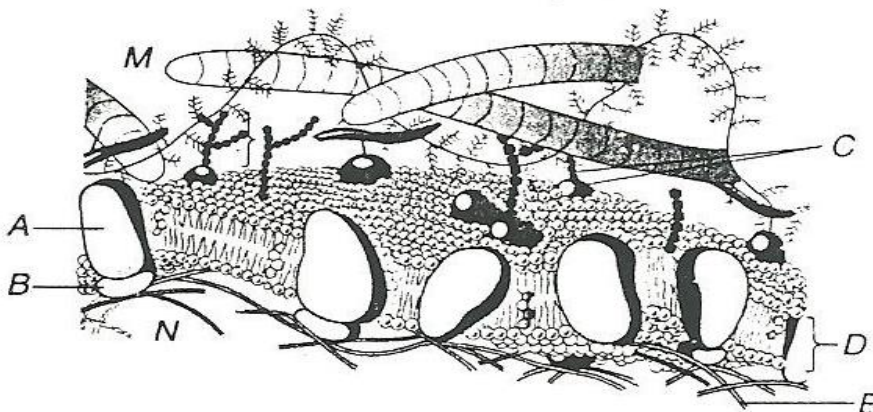

- (a) (i) State the name given to this model of the plasma membrane (1 Mark)

- (ii) Give two reasons why it is so called (2 Marks)
- (b) (i) State where the cytoplasm can be found, on side M or N?
- (ii) Give a reason for your answer in (i) above
- (c) (i) Name the structures labelled A to E
- (ii) Give the average value for the width of D
- (d) (i) State one function each of structures C, D and E

12. Explain how the following are suited for their functions

- a) nucleus (3 marks)
- b) Chloroplast (3 marks)
- c) Mitochondrion (3 marks)
- d) Endoplasmic reticular (1 mark)

13. (a) How do the components of the plasma membrane ensure its fluidity? (06 marks)

(b) Relate the function (s) of each of the following to the fluidity and porosity of their membranes?

- (i) Plasma membrane (06 marks)
- (ii) Rough Endoplasmic Reticulum (05 marks)
- (iii) Golgi apparatus (03 marks)

14. In an investigation pea plants were dug up from the field and washed thoroughly. The nodules were removed surface sterilized and transferred aseptically to a sterile liquid culture medium. After two weeks incubation, small samples of culture media were removed and added to trays each containing a batch of pea plants growing in an inert medium. Each batch was watered regularly with a nutrient solution containing a particular concentration of sodium nitrate for four weeks, at the end of four weeks the mean number of root nodules and biomass were obtained from the investigation are shown in the table below.

Nitrate concentration of nutrient solution (arbitrary units)	Mean number of nodules per plant	Biomass of pea plants /gm ⁻²
0	82	140
1	70	200
2	68	230
3	40	350
3.5	20	400
4	10	460
5	0	440
5.5	0	400
6	0	350

- (a) Represent the results of the table above graphically (08 marks)
- (b) Explain the changes in mean number of nodules per plant and changes in the biomass of pea plants with increasing nitrate concentration of nutrient solution (20 marks)
- (c) How was accuracy of results to be obtained ensured throughout the experiment (05 marks)
- (d) (i) on the graph draw a graph to represent the plot for biomass you would expect if the experiment was repeated and in this case the sample culture medium was not added to the trays containing pea plants (02 marks)
- (ii) Suggest reason(s) for the appearance of the graph drawn in d (i) above (03 marks)
- (e) How can the information from the investigation be beneficial in crop production? (02 marks)
15. (a) Describe the structure of a chloroplast (08 marks)
- (b) Compare the structure of a chloroplast with that of a mitochondrion. (12 marks)
16. a) With the help of well labelled diagrams, describe the structures of the following:
- bone
 - cartilage
 - areolar tissue
- b) (i) How is cartilage replaced by bone? (05 marks)

- (ii) Describe how locomotion instabilities are overcome in a bony fish such as Tilapia (marks)
17. a) Describe the structure of meristematic tissue in plants (06 marks)
- b) Explain the role of each of the following in the formation of meristematic tissue in higher plants
- Vascular cambium (07 marks)
 - Cork cambium (07 marks)
18. Relate the structure and function of these tissues
- voluntary muscle (08 marks)
 - parenchyma (06 marks)
 - xylem (06 marks)
 - phloem
19. (a) Describe how each of the following tissues are related to their functions.
- Parenchyma (03 marks)
 - Collenchyma (03 marks)
 - Sclerenchyma (06 marks)
- (b) Explain the distribution pattern of mechanical tissue in a stem and root of a dicotyledonous plant

REFERENCES

- D. T. Taylor, N.P.O. Green, G.W. Stout and **R. Soper**. Biological Science, 3rd edition, Cambridge University Press
- M. B. V. **Roberts**, Biology a Functional approach, 4th edition, Nelson
- C. J. **Clegg** with D. G. McKean, ADVANCED BIOLOGY PRINCIPLES AND APPLICATIONS, 2nd EDITION, HODDER EDUCATION
- Glenn and Susan **Toole**, NEW UNDERSTANDING BIOLOGY for advanced level, 2nd edition, Nelson thornes
- Michael **Kent**, Advanced BIOLOGY, OXFORD UNIVERSITY PRESS
- Michael Roberts, Michael Reiss and Grace **Monger**, ADVANCED BIOLOGY
- J.**SIMPKINS** & J.I.WILLIAMS. ADVANCED BIOLOGY

END

TOPIC 5: MOVEMENT IN AND OUT OF CELLS

Syllabus extract

SPECIFIC OBJECTIVES <i>The learner should be able to:</i>	<i>Content</i> <i>Movement in and out of cells</i>
<ul style="list-style-type: none"> • Describe diffusion, osmosis, active transport, phagocytosis and pinocytosis. • State the factors that affect the processes of diffusion. • Describe the processes of osmosis. • Explain the significance of diffusion and osmosis in organisms. • Explain how solvents and solutes are exchanged in animal and plant tissues or cells across the cell membrane in relation to its structure. • Describe how unicellular organisms obtain water and food. • Explain the relationship between structure and function of a cell membrane. 	<ul style="list-style-type: none"> • Diffusion and osmosis, active transport, phagocytosis and pinocytosis: exocytosis and endocytosis. • Diffusion: factors affecting rate of diffusion, • process of osmosis: including; turgidity, plasmolysis, water potential, osmotic potential, wall pressure. • Significance of diffusion process and significance of osmosis in organisms. • Exchange of solvents and solutes in plant and animal tissues or cells across the cell membrane in relation to its structure. • How unicellular organisms obtain water and food. • Relationship between structure and function of a cell membrane.
<p><i>Movement in and out of cells practical</i></p> <ul style="list-style-type: none"> • Identify habitats with suitable media for organisms' survival. • Demonstrate use of salt in food preservation, use of visking tubing, glass columns, microscope in diffusion and osmosis experiments. • Demonstrate conditions affecting the rate of diffusion. • Demonstrate effects of osmosis on the cell/ tissues. 	<ul style="list-style-type: none"> • Habitats with suitable media for organism's survival • Use of salt in food preservation, use of visking tubing, glass columns and microscope in diffusion experiments. • Conditions affecting the rate of diffusion. • Effect of osmosis in living tissues.

Introduction

The plasma membrane isolates the inside of the cell protoplasm from its extracellular environment. Materials are exchanged between the protoplasm and the extracellular environment across the plasma membrane. The plasma membrane is selectively permeable and allows transport of materials across it.

The transport of substances is important to;

- a. Supply cells with oxygen for respiration and raw materials for anabolism (synthesis of biological molecules)
- b. Regulate the pH and solute concentration for maintaining a stable internal environment for enzymes to function optimally
- c. Excrete toxic waste substances
- d. Secrete useful substances for cell activities

Note: the transport of substances across the cell membrane takes place by two major fundamental processes.

Substances move in and out of cells by the following processes:

- | | |
|--|---|
| <ol style="list-style-type: none"> 1. Simple diffusion 2. Facilitated diffusion 3. Osmosis 4. Active transport 5. Endocytosis | <ol style="list-style-type: none"> i. Phagocytosis ii. Pinocytosis iii. Receptor mediated endocytosis 6. Exocytosis |
|--|---|

SIMPLE DIFFUSION

Diffusion is the random movement of ions or molecules from a region where they are at higher concentration to a region of their lower concentration. That is, to move **down a concentration gradient** until equilibrium is reached. The phospholipid bilayer is permeable to very small and uncharged molecules like oxygen and carbon dioxide. These molecules diffuse freely in and out of the cell through the phospholipid bilayer.

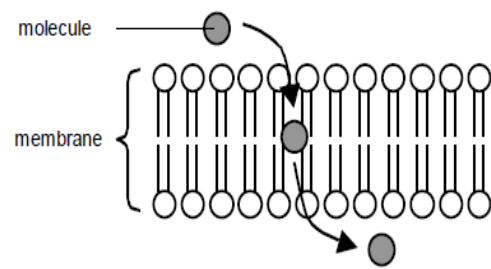

Hydrophobic substances (lipid-soluble) e.g. steroids, can also diffuse through. These non-polar molecules do not require the aid of membrane proteins (channel or carrier) to move across the cell membrane.

The rate of diffusion depends upon;

a) The concentration gradient

This refers to the difference in the relative concentration on either side of the membrane or between two points. The greater the difference between the points, the faster the rate of diffusion and if the difference is less, the slower the diffusion rate. Therefore a reduced concentration gradient causes a reduced rate of diffusion and vice versa.

b) Distance over which diffusion takes place

This is the distance over which the molecules are to travel i.e. the surface thickness across which the molecules move. The greater the distance the lower the rate of diffusion. This is another factor which limits cell size.

Note: the inverse square law states that the rate of diffusion is proportional to the reciprocal of the distance. Diffusion is therefore only effective over very short distances.

c) Surface area over which diffusion occurs

The larger the surface area over which the molecules are exposed, the faster the rate of diffusion.

Fick's law summarises the three factors. It states that 'the rate at which one substance diffuses through another is directly proportional to $\frac{\text{surface area} \times \text{difference in concentration}}{\text{thickness of membrane}}$

d) Temperature

When increased, temperature causes an increased rate of diffusion because the particles acquire increased kinetic energy which causes increased speed of movement hence increased rate of diffusion.

At low temperatures, the kinetic energy is very low and the speed of movement by particles is equally very low.

e) Size and nature of diffusing molecules

The smaller the size of the diffusing particles, the faster they diffuse i.e. smaller particles move very fast while the large ones will move slowly.

Fat soluble molecules (non-polar substances) diffuse more rapidly through the cell membrane than water soluble (polar) molecules.

f) Permeability

The more porous a surface is, the greater the number of particles that diffuse through it hence the greater the rate of diffusion. Diffusion rate increases with increase in size of the pores.

Significance of diffusion

1. It's a means by which gaseous exchange occurs in plants and animals e.g. in plants diffusion of gases occur through the stomata and in animals, in gills of fish, the skin and buccal cavity of amphibians alveoli of reptiles, mammals and birds.
2. Absorption of certain digested food materials e.g. glucose in the ileum.
3. A means of exchange of materials between blood in capillaries and the tissues

4. Movement of chlorides and hydrogen carbonate ions into and out of red blood cells during the chloride shift occurs by facilitated diffusion
5. During formation of the nerve impulse, sodium ions diffuse into the nerve cells facilitating generation of nerve impulses and ensures transmission of nerve impulses from one neurone to another i.e. diffusion facilitates synaptic transmission
6. It ensures excretion of waste products e.g. ammonia in fresh water fishes
7. It's the main means of transportation of materials within the cell's cytoplasm e.g. in unicellular organisms
8. Absorption of mineral salts by plants from the soil is effected by diffusion as one of the mechanisms

Fick's law suggests that structures are adapted to maximise the rate of diffusion by;

- (i) Having a steep concentration gradient
- (ii) Having a high surface area to volume ratio
- (iii) Being thin to minimise the distance over which diffusion occurs

In order maximize the rate of diffusion, tissues where diffusion occurs attained **special adaptations**. These include;

- a) The lungs are ventilated by the respiratory tract (trachea, bronchus, bronchioles) which maintain a steep concentration gradient between the lung alveoli and blood in the capillaries.
- b) Respiratory surfaces like the lung alveoli and intestine epithelial lining possess a rich supply of blood vessels which transport away the diffusing materials hence maintaining a steep gradient which sustains the fast diffusion
- c) Diffusion surfaces e.g. lung alveoli and intestines (ileum) are covered by a thin epithelium lining which reduces the distance over which diffusion takes place.
- d) The epithelial lining covering the alveoli and rumen of the ileum is very permeable to allow molecules to travel across them
- e) In lungs there are numerous alveoli and in the ileum infoldings known as villi and microvilli which is coupled with a very long ileum also increases the surface area along which particles move into cells hence increase the rate of diffusion.
- f) Flattened body e.g. platyhelminthes (flatworms) which increases the surface area for movement of materials by diffusion
- g) Some organisms are of small size e.g. unicellular organisms which increases the surface area to volume ratio of the surface that permits increased rate of diffusion

FACILITATED DIFFUSION

This refers to the passive transport of molecules and ions across a membrane by specific transport proteins, carrier and channel proteins, found within the membrane in the direction of lower concentration of the ions or molecules i.e. in favour of the concentration gradient (difference) of ions.

Facilitated diffusion is a faster form of movement than simple diffusion and it involves transport of large polar molecules and ions that cannot be transported by simple diffusion. Even though water is an extremely small, its polar therefore it does not move across the cell membrane by simple diffusion.

A charged molecule or atom and its surrounding shell of water, find the hydrophobic layer (non-polar) of the membrane more difficult to penetrate thus the lipid bilayer partly accounts for the membrane's selective permeability by preventing very large molecules and small polar molecules of ions to move across it.

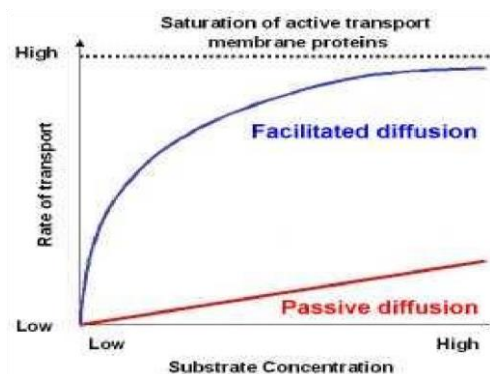

Trans-membrane proteins form channels or act as transport proteins to facilitate and increase the rate of diffusion across the semi permeable membrane. The transport protein molecules involved in facilitated diffusion include channel and carrier proteins.

Facilitated diffusion by carrier proteins

Some small hydrophobic organic molecules e.g. amino acids and glucose pass through the cell membrane by facilitated diffusion using carrier proteins. These proteins are specific for one molecule, so substances can only cross a membrane if it contains the appropriate proteins i.e. they are specific.

The transport of glucose across the plasma membrane of fat cells, skeletal muscle fibres, the microvilli of the ileum mucosa and across proximal convoluted tubule cells of vertebrate kidneys is brought about by a change in the shape of the carrier protein once the glucose molecule bonds to it. The binding state is called the ping state and the releasing state is the pong state.

Carrier proteins alter their conformation/shape when moving the solute across the membrane.

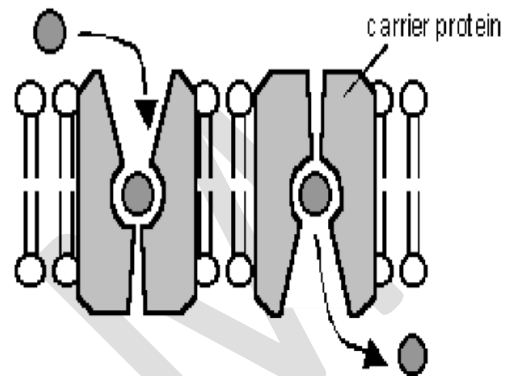

The solute molecule is released on the other side of the membrane, down its concentration gradient. The carrier proteins bind molecules to them at the binding site and then change shape so as to release the molecules on the other side.

Facilitated diffusion by protein channels:

These trans-membrane proteins form water-filled hydrophilic functional pores in the membrane whose shape is specific for the passage of particular ions or polar molecules.

This allows charged substances, usually ions, and polar molecules to diffuse across the cell membrane. Most channels have fixed shapes and can be gated (opened or closed), allowing the cell to control the entry and exit of the ions, these include the ligand-gated and voltage gated channels. Transport proteins allowing the passage of ions are called ion channels. The proteins form specific water filled hydrophilic channels that permit the diffusion of various ions such as K^+ , Na^+ , Ca^{2+} , Cl^- , HCO_3^- .

There are also specialised channels for water known as aquaporins found in both plant and animal cells. The aquaporins speed up the rate of diffusion of water molecules down its water potential gradient.

Fig 2 & 3 pg 69 Kent OR Fig 5.17 pg 144 Soper OR Fig 4.18 pg 67 Toole Fig 2

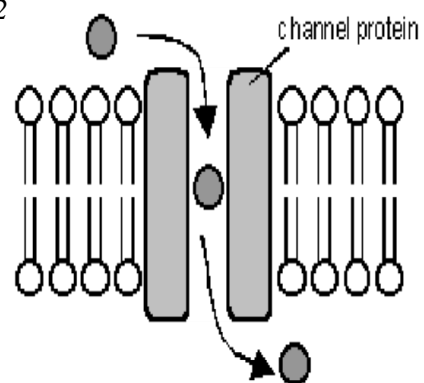

Comparison between simple and facilitated diffusion		
Similarities	Differences	
	Simple	Facilitated
Both move molecules from a region of high concentration to a region of low concentration through a partially permeable membrane	Diffusion can occur in either direction	Diffusion occurs in only one direction
	Similar molecules diffuse at the same rate	Specific molecules diffuse faster than others
	Does not require special transport proteins	Occurs via special channels or carrier proteins

ACTIVE TRANSPORT

It is the movement of molecules or ions across a cell membrane against their concentration gradient aided by the protein pump with specific binding sites, involving the expenditure of energy.

Cells which carry out active transport have a high respiratory rate and a large number of mitochondria to generate a high concentration of Adenosine Tri Phosphate (ATP). The energy from ATP can be directly or indirectly used in active transport.

Active transport can be slowed or inhibited by respiratory poisons (inhibitors) e.g. cyanide or lack of oxygen.

Mechanism of active transport

This can be direct active transport if the energy from ATP is used directly to transport the substances, ions or molecules, or it can be indirect active transport if the energy is not directly used to transport a substance across a membrane.

Types of membrane proteins involved in active transport. Three main types of membrane proteins exist;

- Uniport carriers. They carry (transport) a single ion or molecule in a single direction.
- Symport carriers. They carry two substances in the same direction.
- Antiport carriers. They carry two substances in opposite directions.

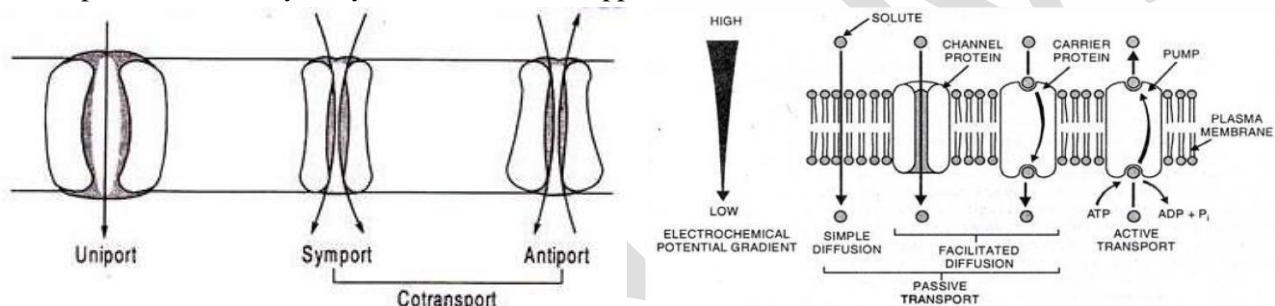

One common example of active transport is the sodium-potassium which actively removes sodium ions from cells, while actively accumulating potassium ions into the cell from their surroundings.

Direct active transport (e.g. Na^+ - K^+ pump)

The sodium potassium pump is a carrier protein which spans the cell membrane from one side to the other. The Na^+ - K^+ pump accepts sodium ions and ATP on the inside, while it accepts potassium ions on the outside. ATP is hydrolysed to ADP and an inorganic phosphate by enzyme ATPase.

The binding of the phosphate and sodium to the inside of the protein pump changes the protein conformation. The protein pump actively transports three sodium ions (3Na^+) out of the cell for every two potassium ions (2K^+) pumped against their concentration gradient into the cell.

Illustration Fig 5.21 pg 146 Soper

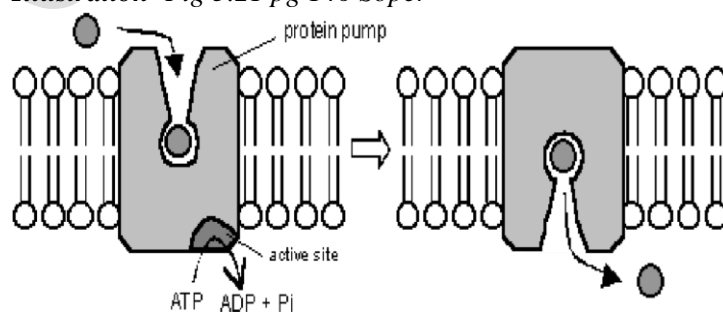

This generates a difference in ionic charge on the two sides of the membrane i.e. the inside of the cell becomes negative with respect to the outside. This potential difference across the membrane is important for the transmission of nerve impulses. The Na^+ gradient is also used in the coupled uptake of solutes such as glucose into the cells against its concentration gradient.

Importance of the sodium-potassium pump

- Maintains electrical activity in nerve and muscle cells
- Drives active transport of other substances such as sugars and amino acids
- Provides the high concentration of potassium ions needed inside cells for protein synthesis, glycolysis and other vital processes

(iv) Controls osmotic balance of animal cells during osmoregulation

Note: if the pump is inhibited the cell swells and bursts, because buildup of sodium ions inside the cells results in excess water entering the cells by osmosis. However, bacteria, fungi and plants which have cell walls do not need the sodium potassium pumps.

Indirect active transport mechanism (secondary active transport)

This is also known as **co-transport** i.e. a form of active transport in which the pumping of one substance indirectly drives the transport of one or more other substances against a concentration gradient e.g. the coupled uptake of glucose into cells lining the ileum in mammals where glucose and Na^+ ions are absorbed into the cells. Sodium ions move down a concentration gradient while the glucose molecules against the concentration gradient. In co-transport of Na^+ and glucose, ATP is used by the protein pump to pump Na^+ out of the cell creating a Na^+ concentration gradient. The Na^+ and glucose molecules then bind to trans-membrane protein (carrier protein), also called co-transport proteins/coupled transport proteins.

They are then moved by the proteins inside the cells i.e. the Na^+ moves down its concentration gradient while the glucose molecules moves down against its concentration gradient.

A similar process transports glucose and amino acids into the cells having the digestive tract in mammals. But here, absorption of nutrients is dependent on the sodium-potassium pump.

The factors required for active transport to take place;

1. Temperature

Increase in temperature increases the rate of transport of substances by active transport, so long as the increase is not above the optimum. The increase in temperature makes respiratory enzymes more active, having their speeds of movement increased (kinetic energy) with that of substrate molecules which results into collisions of molecules at a faster rate thus forming enzyme substrate complexes that form products. In this case, ATP is required to power active transport.

At very high temperatures, above the optimum, respiratory enzymes are denatured in the carrier proteins in the membrane. This reduces the rate of active transport.

At very low temperatures, below the optimum, the respiratory enzymes together with the carrier proteins are inactive and this reduces the rate of active transport.

2. Availability of oxygen

Oxygen is required for aerobic respiration to generate ATP. Increase in oxygen concentration results into increased rates of active transport as more ATP molecules are available for the process. In circumstances of very little or no oxygen, the rate of active transport is reduced since in the case of anaerobic respiration, there's very little or no ATP molecules available for active transport

3. Concentration of respiratory substrates e.g. glucose

If the concentration of respiratory substrate is increased, the rate of active transport also increases and if it is lowered, the rate of active transport lowers. This is because increase in the amount of the substrate increases the rate of ATP generation during respiration. If the amount of substrate is reduced, the rate of ATP generation is also lowered.

Importance of active transport

1. It is a means of absorption of food materials in the mammalian gut
2. It is the means of absorption of mineral salts by plant root hairs and the root epidermal cells of the periferous layer
3. Selective reabsorption of glucose and sodium ions from the proximal convoluted tubule, and sodium ions from kidney cortex occurs by active transport

Illustration Fig 2 pg 70 Kent

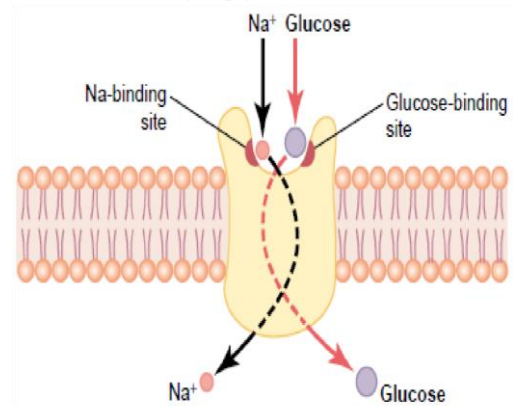

4. It facilitates the excretion of waste materials from the cells to the extracellular fluids against a concentration gradient e.g. excretion of urea
5. It is important in muscle contractions and relaxations where there's active pumping in and out of calcium ions inside the cytoplasm (sarcoplasm) of the muscle.
6. It is used in the loading and unloading of materials in the plants phloem tissue which creates pressure differences in the phloem tissue that maintain mass flow of materials.
7. Active transport is vital in transmission of nerve impulses along nerve cells where it creates a membrane action potential using the potassium-sodium pumps.
8. It plays a part in the opening and closure of stomata where differential pumping of potassium ions between the guard cells and neighboring subsidiary cells lead to turgidity changes hence causing stomatal movements (opening/closure).
9. Removal of excess water from amoeba by contractile vacuoles occurs by active transport
10. Fresh water fish carry out the active uptake of mineral ions from the external environment by special cells in the gills

Note: metabolic poisons (inhibitors), inhibit the enzymes and carrier proteins required to bring about active transport by either changing the active sites/binding sites for the enzymes/carrier proteins for the molecules to be transported. The poisons also inhibit ATP synthesis hence cutting off the source of energy needed to effect the active transport.

Differences between the functioning of carrier proteins in facilitated and those in active transport

Carrier proteins in facilitated diffusion	Carrier proteins in active transport
1. Do not use ATP	1. Use energy in form of ATP
2. Carry substances from a region of their lower concentration	2. Carry substances usually from a region of their lower concentration to a region of their higher concentration
3. Not affected by metabolic rate/ respiratory inhibitors/ oxygen concentration/ concentration of respiratory substance e.g. sugar, glucose	3. Affected by metabolic rate/ respiratory inhibitors/ oxygen concentration/ concentration of respiratory substances e.g. sugars
4. Carry substances slower	4. Carry substances faster
5. Carry substances in both directions across a membrane	5. Carry a particular substance in one direction

Differences between diffusion and active transport

Diffusion	Active transport
1. Materials move down their concentration gradient	1. Materials move usually against their concentration gradient
2. Does not require energy in form of ATP	2. Energy in form of ATP is used
3. Slower	3. Faster
4. Allows all transmissible molecules and ions to pass through cell membranes	4. Causes selective uptake of materials
5. Not affected by metabolic rate	5. Affected by metabolic rate
6. Not affected by lack of oxygen	6. Affected by lack of oxygen
7. Not affected by metabolic reactions	7. Affected by metabolic reaction

OSMOSIS

This is the passive movement of water molecules, across a partially permeable membrane, from a region of lower solute concentration to a region of higher solute concentration. It may also be defined as the passive

movement of water molecules from a region of higher water potential to a region of lower water potential through a partially permeable membrane.

A selectively permeable membrane is one that allows unrestricted passage of water molecules but no passage of solute molecules. Different concentrations of solute molecules lead to different concentrations of free water molecules on either side of the membrane. On the side of the membrane with a high concentration of free water molecules (low solute concentration), more water molecules will strike the pores in the membrane in a given interval of time,

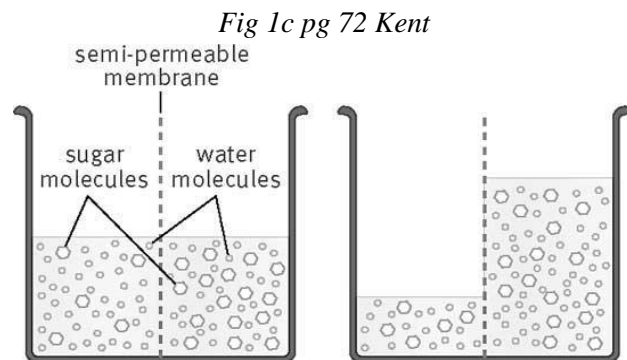

water molecules pass through the pores resulting in net diffusion of water molecules from the region of high concentration of free water molecules to the region of low concentration of free water molecules.

A net flow of free water molecules is maintained because in the side with more solute molecules, water forms hydrogen bonds with solutes which are charged or polar forming a hydration shell around them in solution, making water molecules unfree and therefore cannot flow back across the membrane.

Osmosis and aquaporins

In living cells, transport of water across the cell membrane is facilitated by channel proteins called aquaporins which have specialised channels for water.

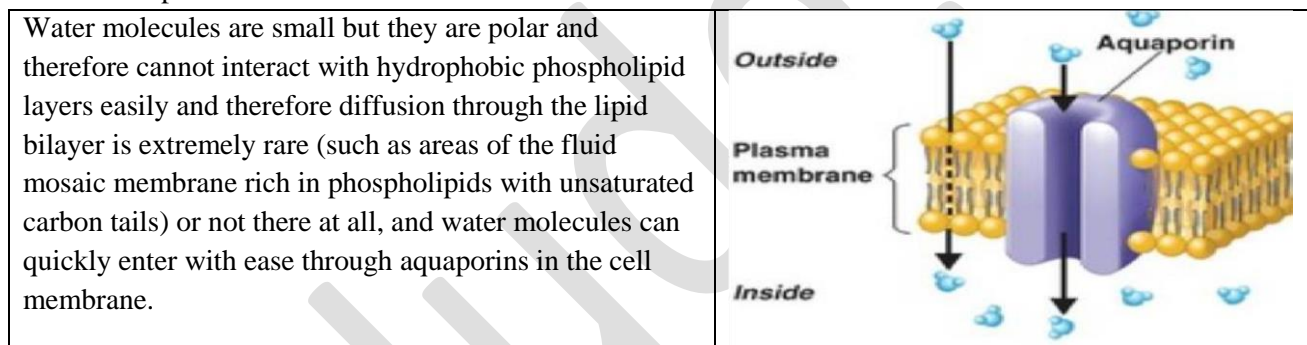

Water potential

This is the net tendency of any system to donate water to its surroundings OR the term given to tendency of water molecules to enter and leave a solution by osmosis. The symbol for the water potential is Ψ , the Greek letter psi, and is usually measured in kilopascals (Kpa).

The higher the concentration of water molecules in a system, the higher the total kinetic energy of water molecules in that system, and the higher is its water potential. The water potential of pure water is zero pressure units and any addition of solute to pure water reduces its water potential and makes its value negative i.e. pure water has the highest water potential.

In pure water or dilute solution with very few solute molecules, the water molecules have a *high free kinetic energy* and can move very freely. A dilute solution therefore has a higher water potential than a concentrated solution. This is because the movement of the water molecules is restricted by the attraction between solute and water molecules i.e. there are fewer water molecules with a *high kinetic energy* to move across the membrane. This is because water is a polar molecule which attracts the positive part of the solute (cation) to its partially negatively charged oxygen atom, negative part of the solute (the anion) is attracted to the slightly positively charged hydrogen part of the water, forming hydrogen bonds. This reduces the mobility of the water molecules, lowering their kinetic energy, and decreasing the tendency of the system to lose water molecules.

The greater the concentration of solutes, the more negative is the water potential. Water potential of a plant cell, ψ_w , is the algebraic sum of its wall pressure (pressure potential) ψ_p and its osmotic (solute) potential ψ_s . A concentrated solution has a low water potential and water therefore moves down a water potential gradient i.e. water diffuses from a region of high water potential (less negative or zero value) to a region of lower water potential (more negative value). The water potential of pure water ψ_w at atmospheric pressure is arbitrarily given the value of 0 Kpa $\psi_w = 0$ Kpa. The water potential of solutions is therefore less than 0 i.e. $\psi_{\text{solution}} < 0$ Kpa.

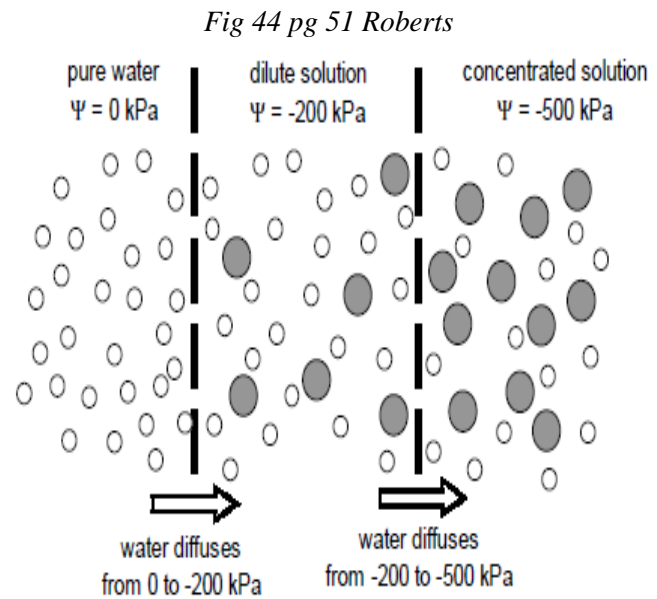

Water potential is affected by amount of solutes and external pressure.

When an external pressure is applied to pure water or a solution, its water potential increases. This is because the pressure forces water molecules out of the system.

Solute potential (ψ_s)

This is the potential or force of attraction towards water molecules caused by dissolved substances (solutes) inside the solution. That is to say, a change in water potential of a system in the presence of solute molecules. The attraction between solute molecules and water molecules reduces the random movement of water molecules. The addition of more solute molecules lowers the water potential of a solution.

- Solute potential/osmotic potential is denoted by (ψ_s) and is equal to 0 for pure water
- Solute potential is always negative for solutions because the forces of attraction between the solute molecules and water molecules reduce the movement of water molecules.
- For a solution, water potential is equal to solute potential and is always negative

Pressure potential (ψ_p)

This is the pressure exerted on a fluid by its surrounding. At any one time, the water potential of a plant is the sum of the solute potential and pressure potential. Pressure potential is usually, though not always, positive.

$$\psi_w = \psi_s + \psi_p$$

ψ_w	$=$	ψ_s	$+$	ψ_p
Water potential of plant cell		Solute / osmotic potential		Pressure potential

When water enters the cell by osmosis, the pressure of the cytosol builds up, pushing out against the cell membrane. This pressure is called hydrostatic pressure. In plant cells, this pressure builds up pushing the cell membrane against the cell wall. Because the cell wall is capable of only very limited extension, a pressure builds up that resists further entry of water. The cell wall begins to resist the swelling caused by the influx of water. The pressure that the cell wall develops is the pressure potential. For plants therefore, pressure potential is the pressure exerted on the cell contents by the cell wall and cell membrane.

Pressure potential is usually positive, but in the xylem of a transpiring plant the water column is under tension and the pressure potential is negative.

Osmotic pressure and cell relationship

Osmotic pressure is the hydrostatic pressure needed to stop osmotic flow. If the membrane is strong enough, the cell reaches an equilibrium, a point at which the osmotic pressure drives water into the cell exactly

counterbalanced by the hydrostatic pressure which tends to drive water back out of the cell. However, the plasma membrane itself cannot withstand the large internal pressures and an isolated cell under such conditions would just burst. In contrast, cells of prokaryotes, fungi, plants and many protists are surrounded by a strong cell wall which can withstand high internal pressure without bursting.

If a cell is surrounded by pure water or a solution whose concentration is lower than that of the cell contents, water will osmotically flow into the cell; such a solution with a lower osmotic pressure than that of the cell's cytoplasm is said to be **hypotonic**. If the cell is surrounded by a solution whose solute concentration exceeds that of the cell cytoplasm, water flows out of the cell. In this case the outer solution is said to be **hypertonic** to the cell cytoplasm. If the cell concentration of the cell cytoplasm and the surrounding medium are the same and there would be no net flow of water in other directions and the external solution is said to be isotonic. The osmotic flow of water into the cell is **endosmosis** and the osmotic flow of water out of the cell is **exosmosis**.

Hypertonic solution	Hypotonic solution
1. Higher concentration of solute molecules	1. Lower concentration of solute molecules
2. Lower solute potential	2. Higher solute potential
3. Lower concentration of water molecules	3. Higher concentration of water molecules
4. Lower water potential	4. Higher water potential
5. Higher osmotic pressure	5. Lower osmotic pressure
6. More negative water potential	6. Less negative water potential
7. More negative solute potential	7. Less negative solute potential

Osmosis and plant cells

A plant cell will be divided into three main parts

- (i) The **cell wall**, which is freely permeable, except when impregnated with lignin
- (ii) The **cytoplasm**, which is surrounded internally by the tonoplast and externally by the plasma membrane. Both the tonoplast and plasma membrane are partially permeable.
- (iii) The cell vacuole, which contains an aqueous solution of salts, sugars and organic acids.
- (iv)

a. Turgidity

When the external solution is **hypotonic** e.g. distilled water, the cell's cytosol has a lower water potential, causing an influx of water into the cells. The water enters into the cells vacuole, by osmosis, through the partially permeable plasma membrane and tonoplast. The volume of the cell protoplasm increases, the protoplast swells causing an internal hydrostatic pressure developed by the cell hence the cell wall stretches. The pressure potential reaches its maximum when the cell wall is stretched to its maximum. At this point, the cell is described as a **fully turgid** or it has **full turgor** reached and the water potential at this point equals to 0 i.e. $\Psi=0$ and no more water can enter the cell.

Turgor pressure plays part in supporting plants and maintains their shape and form of herbaceous plants by being filled with fully turgid cells tightly packed together. It is also responsible for holding leaves in flat and horizontal position as well as the opening of the stomata. This is because the cell wall is tough and rigid hence resisting expansion of the protoplast so the cell wall exerts an equal and opposite pressure against the protoplast, and the rapidly increasing hydrostatic pressure inside the cell causing a buildup of the pressure potential. The pressure of the cell wall against the expanding protoplast is called **wall pressure**.

Importance of turgidity in plants

1. Turgor pressure maintains the shape and form of a plant
2. Stems of herbaceous plants and non-woody plants are maintained in an erect position by fully turgid cells tightly packed together to provide support
3. Turgor pressure holds leaves on a flat and horizontal position to receive sunlight.

4. Turgor pressure maintains the floral whorls of flowers open for pollination
5. Turgor pressure causes cell enlargement and stretches stems causing increase in girth
6. The rapid nastic responses of some plants, e.g. thigmonastic collapses of leaves and stems of *Mimosa pudica* are due to changes in turgidity
7. Closing and opening of stomata by guard cells

Fig 4.5 pg 52 Roberts

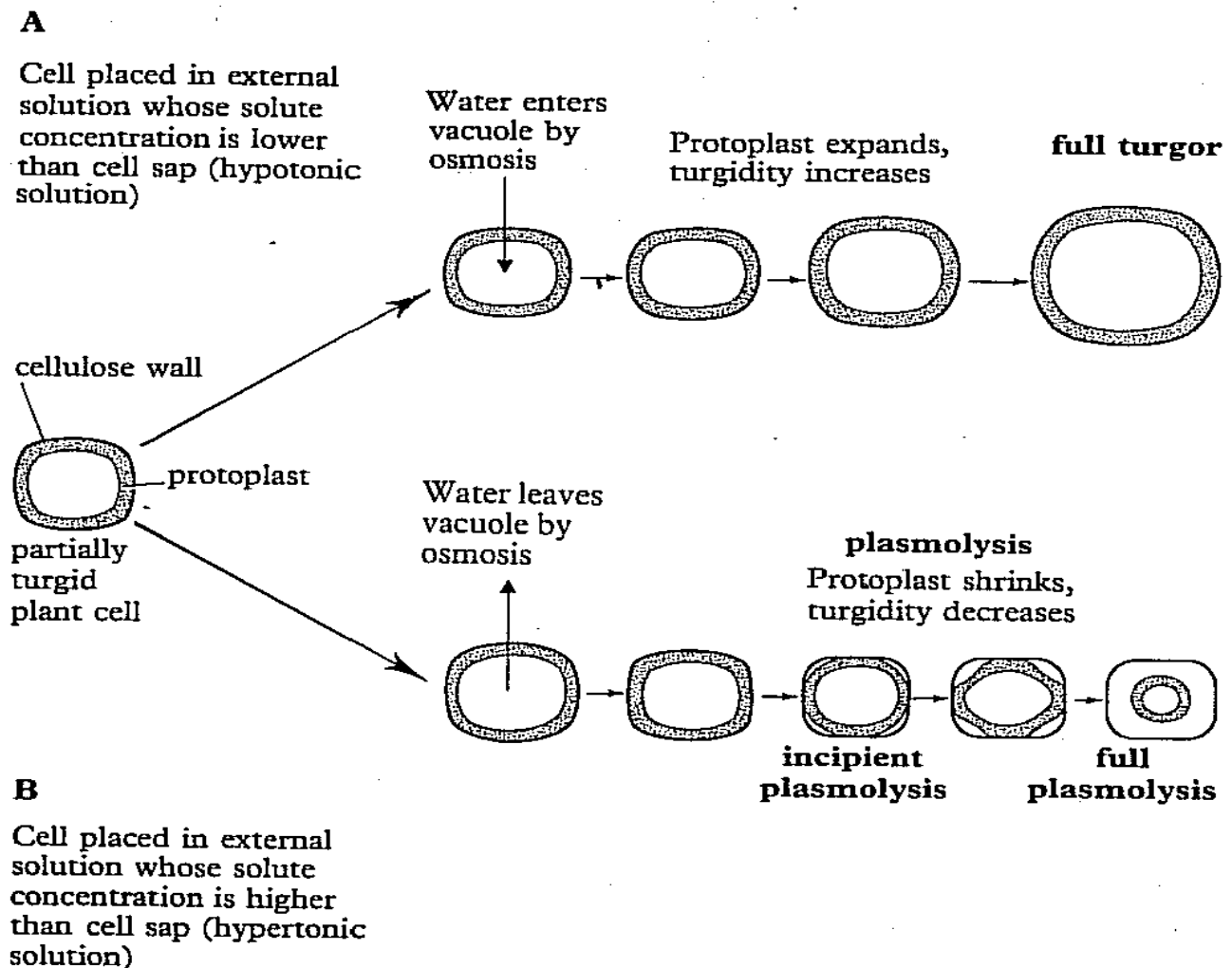

b. Plasmolysis

When a plant cell is immersed in a hypertonic solution, than its cytosol, the cell decreases in volume as water moves out osmotically from its vacuole through the partially permeable plasma membrane and tonoplast. The protoplast shrinks, pulling away from the cell wall and leaving gaps between the cell wall and plasma membrane. A cell in this condition is said to be **plasmolysed** and the cell becomes **flaccid**.

Plasmolysis is the shrinking of a plant cell's protoplast away from the cell wall leaving gaps between the cell wall and the plasma membrane.

When a plant cell is placed in hypertonic solution, it loses water by exosmosis. The protoplast shrinks and pulls away from the cell wall. Also on a dry and hot day, the plant cells lose their way **evaporation** and the turgor pressure of the plant cells is reduced with the result that the plant droops. The phenomenon is called **wilting**. This is the drooping of leaves and stems as a result of plant cells losing water exosmotically and becoming flaccid. A plant suffers from **water stress** when it loses more water by **transpiration** than it absorbs by the roots.

Effects of water stress in plants

- (i) Excessive water loss causes drooping of shoots and leaves, which produce abscisic acid so as to close the stomata and reduce on the rate of transpiration. This leads to reduction in the rate of photosynthesis due to lack of carbon dioxide
- (ii) There's reduced growth and stunting due to reduced photosynthesis
- (iii) Excessive water loss causes dessication and drying up of the plant

Plant-water relations

This takes into account of three forces which include;

- a. Solute potential Ψ_s
- b. Pressure potential (Ψ_p).
- c. Water potential of the cell sap Ψ_w

Graphical illustration of a relationship between Ψ_s (osmotic potential), Ψ_w (water potential of the cell) and pressure potential (Ψ_p) of a plant cell at different stages of turgor and plasmolysis is shown below

Fig 4.6 p.g. 54 Roberts

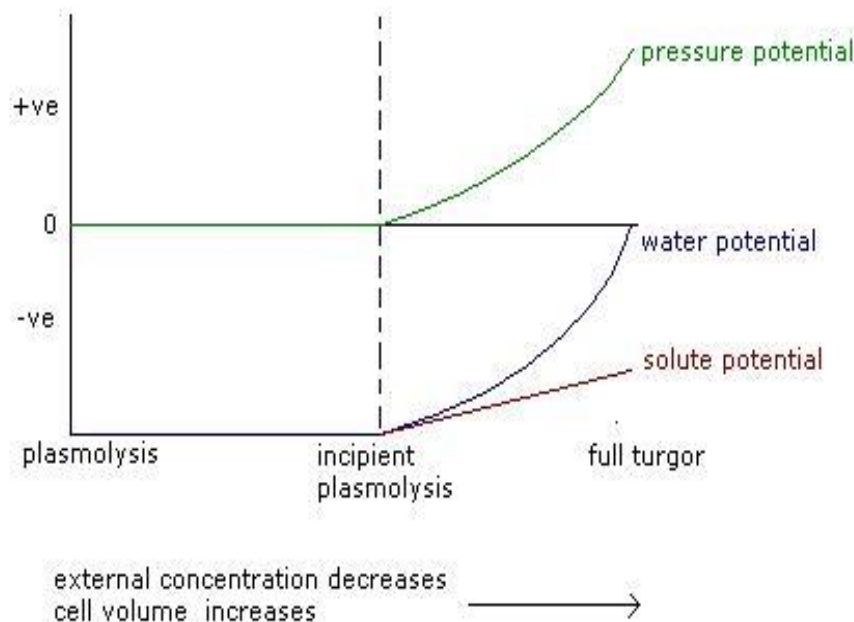

From **full plasmolysis to full turgidity** (full turgor) the **solute potential increases gradually** because the osmotic entry of water into the cell gradually reduces the concentration of solutes in the cell. The attraction between solute molecules and water molecules reduces which increases the random movement of water molecules hence increasing the solute potential. At full turgidity, the water potential is equal to 0Kpa and solute potential is equal to pressure potential.

Considering a fully plasmolysed cell, its **pressure potential** is 0Kpa since the protoplast is completely pulled away from the cell wall, so the cell wall does not exert pressure on the protoplast.

From **full plasmolysis to incipient plasmolysis**, the pressure potential **remains constant at 0Kpa**. This is because the protoplast remains pulled away from the cell wall, so the cell wall does not exert any pressure against the protoplast. When immersed in pure water, water enters the sap osmotically and the protoplasm begins to expand. As the osmotic influx of water continues, the protoplast goes on expanding until the cell membrane comes slightly into contact with the cell wall, incipient plasmolysis, but it is not pressed against it, so the protoplast exerts no pressure against the cell wall so the pressure potential remains 0.

From **incipient plasmolysis to full turgidity** (full turgor) the pressure potential **increases rapidly** (becomes positive). As the cell continues to expand, due to the osmotic influx of water, the volume of the protoplasm increases. The osmotic influx of water into the cell is opposed by the inward pressure of the cell wall i.e. pressure potential. The protoplast exerts pressure against the cell wall and the rigid cell wall exerts pressure back against the protoplast causing a rapid increase in the pressure potential of the cell.

At full plasmolysis, the **water potential** of the cell is low (more negative) since the protoplast has a high concentration of solutes and a low concentration of water molecules. From full **plasmolysis to incipient plasmolysis**, the water potential **increases gradually** (becomes less negative) because the osmotic entry of water into the cell gradually increases the concentration of water into the cell.

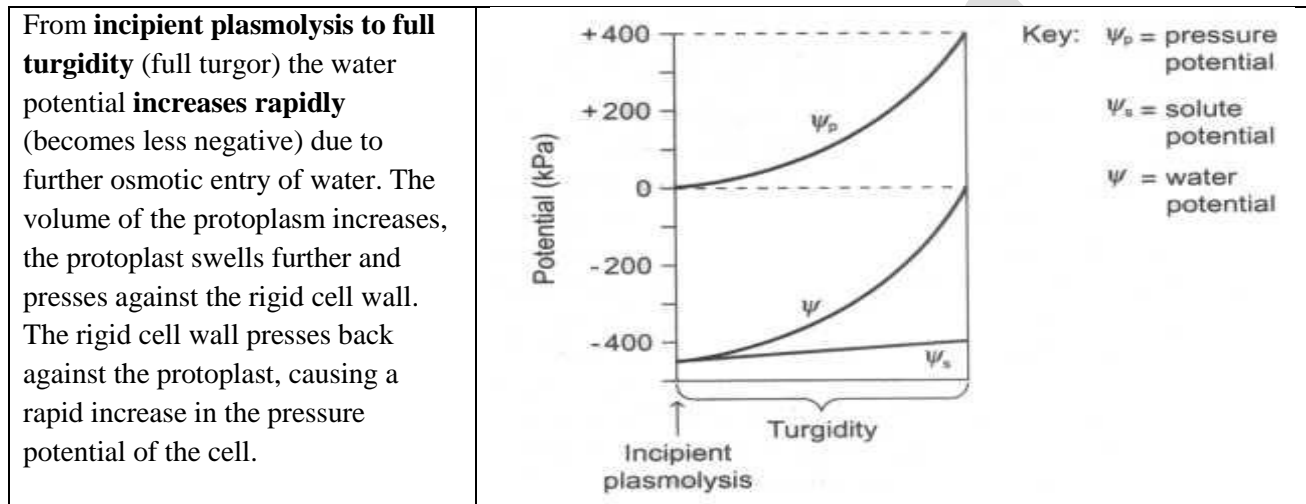

The water potential of increases rapidly due to the rapidly increasing pressure potential, until the water potential becomes 0Kpa at full turgidity at which point the cell cannot take in more water. When full turgor is reached, the cell cannot expand anymore and at this point Ψ_s (osmotic potential) is exactly outbalanced by the pressure potential (Ψ_p). If the solution produces no change within the volume of the cell, it has a solute concentration similar to that of the cell sap or tissue and therefore water potential of the solution equals to the water potential of the cell or tissue.

In general:

- $\Psi_{\text{cell}} = \Psi_s$ (always negative) + Ψ_p (always positive)
- At total plasmolysis; the vacuole almost disappears, minimum hydrostatic pressure, cell membrane completely not attached to the cell wall. Cell generally small and described as flaccid.
- At incipient plasmolysis; cell membrane begins to leave cell wall and water is lost from the cell.
- At full turgidity; the cell vacuole with maximum volume and no more water can enter.

Differences between wilting and plasmolysis

Wilting	Plasmolysis
1. Occurs due high temperature	1. Occurs due to an osmotic gradient
2. The entire cell, including the cell wall, shrink	2. Only the protoplast shrinks away from the cell wall
3. Water loss is serious leading to dessication which causes death	3. Water loss is not serious and can hardly result into death
4. Results in drooping of shoots and leaves of the plant	4. Does not result into drooping of leaves and shoots of the plant

Osmosis and animal cells

If the red blood cells are placed in a **hypotonic solution** i.e. 0.5% sodium chloride, water enters the cells by osmosis. The cell expands (swells) and the thin plasma membrane bursts, releasing the cell contents, this is called **haemolysis**. Haemolysis is due to red blood cells lacking cellulose cell walls which would prevent red blood cells expansion and therefore stops bursting.

If a human red blood cell is placed in an **isotonic solution** i.e. 0.9% sodium chloride solution, the cell neither shrinks nor swells/no change in shape or volume because there's no net movement of water molecules .

If the red blood cells are placed in a **hypertonic solution** i.e. 1.2% sodium chloride, there is a net outflow of water by osmosis. The cell shrinks and the cell membranes appears crinkled and this is called **crenation**.

Note: unicellular protists e.g. *Amoeba* and *Paramecium* have contractile vacuoles to regulate the water content in the cell.

Role of osmosis in living organisms

1. It is the main form by which root hairs and piliferous layer cells on roots absorb water from the soil
2. Movement of water from the root via the root cortex to the xylem
3. In herbaceous plants, osmosis brings about turgidity in plant cells due to presence of cell wall leading to provision of support and shape in a whole plant body.
4. Osmosis causes plant structures (organs) like leaves and flowers to determine their form for example holding the leaf in flat and horizontal position enabling it to trap maximum sunlight.
5. Osmosis bring about opening and closure of petals of flowers and osmosis bring about the opening and closure of stomata in plant leaves when the guard cells become turgid facilitating gaseous exchange in plants
6. Movement of water from the gut into the blood stream
7. Kidney nephrons (tubules) re-absorb water back into the blood stream via the blood capillaries osmotically leading to water conservation in the body hence bringing about osmoregulation

Factors affecting osmosis in physical systems

1. Temperature

Provided pressure is constant, when a partially permeable membrane separates pure water on two sides, the molecules of water will move from a region with a higher temperature to a region with a lower temperature.

2. Pressure

Provided temperature is constant, when pure water in two sides of a partially permeable membrane is subjected to diffusion pressures, water molecules move from the side with a higher pressure to the side with lower pressure.

3. Solute molecule

Water molecules from a dilute solution to a concentrated solution

Differences between diffusion and osmosis

Diffusion	Osmosis
1. Involves movement of solute or gas molecules	1. Involves movement of solvent
2. Involves movement of solute molecules or ions from a region of their higher concentration to a region of their lower concentration	2. Involves movement of solvent molecules from a region of their higher concentration to a region of their lower concentration
3. Occurs where there are no barriers to movement	3. Occurs through a partially permeable membrane

Differences between active transport and osmosis

Active transport	Osmosis
<ol style="list-style-type: none"> 1. Involves movement of solute molecules 2. Solute molecules move against their concentration gradient 3. Energy is required in form of ATP 4. Occur only in living tissues 5. Occurs across both partially permeable membrane and freely permeable membranes 6. Affected by lack of oxygen/ affected by metabolic poisons/ affected by the metabolic rate 7. Concentration equilibrium is not obtained at the end 8. Carrier proteins required 	<ol style="list-style-type: none"> 1. Involves movement of solvent molecules 2. Solvent molecules move down their concentration gradient 3. No energy is required 4. Can occur in non-living tissues 5. Occurs across a partially permeable membrane 6. Not affected by lack of oxygen/ not affected by metabolic poisons/ not affected by the metabolic rate 7. Concentration equilibrium may be obtained at the end 8. No carrier proteins required

An experiment to determine the water potential of plant materials such as a potato tuber

Apparatus and materials

- Sucrose
- Distilled water
- Potato tubers
- Cork borer
- Beakers
- Stop clock
- Razor blade
- Ruler

Procedure

1. Prepare a series of sucrose solutions on known concentrations e.g. 0.1M, 0.2M, 0.3M, 0.4M, 0.5M and 0.6M.
2. Place the same volume of each solution in six labelled beakers
3. Set up another beaker containing the same volume of distilled water, which is 0.0M
4. Using a cork borer, make seven cylindrical pieces of the potato tuber
5. Make all the cylindrical pieces 3cm long using a razor blade and a ruler
6. Add a potato cylinder to each of the labelled beakers containing the sucrose solutions, including the 0.0M solution
7. Leave the potato cylinders completely immersed in the sucrose solutions for 1 hour
8. Remove the potato cylinders from the sucrose solutions and measure their lengths accurately to the nearest mm

Treatment of results

1. Calculate the percentage increase or decrease in length of the potato cylinders in each of the solutions
2. Plot a graph of percentage change in length against molarity of sucrose solutions
3. From the graph determine the molarity of sucrose solution at which there is no change in length
4. Record the value, and from a set of tables determine the osmotic potential of this solution

Conclusion

The water potential of the potato tuber is equal to the osmotic potential of the sucrose solution at which there is no change in length of the potato cylinder

Determination of the mean solute potential of the cell sap in a sample of plant cells using the method of incipient plasmolysis

The incipient plasmolysis method involves counting the number of plasmolysed cells in a given field of view under the microscope for different concentrations of sucrose solutions then determining the percentage plasmolysis and plotting a graph of percentage of plasmolysed cells against molarity of sucrose solutions.

By interpretation from the graph, the sucrose concentration which occurs when 50% of the cells to be plasmolysed is read off.

Using the relationship:

(a) $\Psi_{\text{cell}} = \Psi_{\text{s cell}} + \Psi_{\text{p cell}}$, and

(b) $\Psi_{\text{solution}} = \Psi_{\text{s solution}}$

When the two are in equilibrium, $\Psi_{\text{cell}} = \Psi_{\text{solution}}$, when $\Psi_{\text{p cell}} = 0$

At incipient solution the protoplasts have shrunk to the point where they begin to pull away from the cell wall and the pressure potential is zero, since no pressure is exerted by the protoplasts against the cell wall, therefore; $\Psi_{\text{cell}} = \Psi_{\text{s cell}} = \Psi_{\text{solution}}$, from (a) and (b) above.

Hence the solution causing incipient plasmolysis has the same solute potential as the cell sap.

So, at 50% plasmolysis the average cell is said to be at incipient plasmolysis, and solute potential of the solution causing this plasmolysis can be obtained to give the mean solute potential of the cell sap, from the tables of the relationships between molarity of sucrose solutions and solute potential of sucrose solutions.

BULK TRANSPORT ACROSS THE CELL MEMBRANE

Cytosis

This is a form of active transport involving infoldings and out-folding of sections of the cell surface membrane resulting into the bulk transport of materials into a cell (endocytosis) or out of the cell (exocytosis). The flexibility of the cell membrane is an important factor in the bulk transport of materials into the cell.

Cytosis involves the contractile proteins in cellular microfilaments and microtubules pulling a small region of a membrane from the rest of the membrane using energy in the form of ATP. Cytosis results in bulk transport of materials into the cell or outside the cell, thus cytotysis is divided into two main types i.e.

- Endocytosis
- Exocytosis

Endocytosis

This is bulk transport of materials inside the cell. It involves a small area of plasma membrane folding inwards (invaginating) to surround a material to be taken in and moves deeper inside the cell. There are three types of endocytosis;

- Phagocytosis
- Pinocytosis
- Receptor-mediated endocytosis

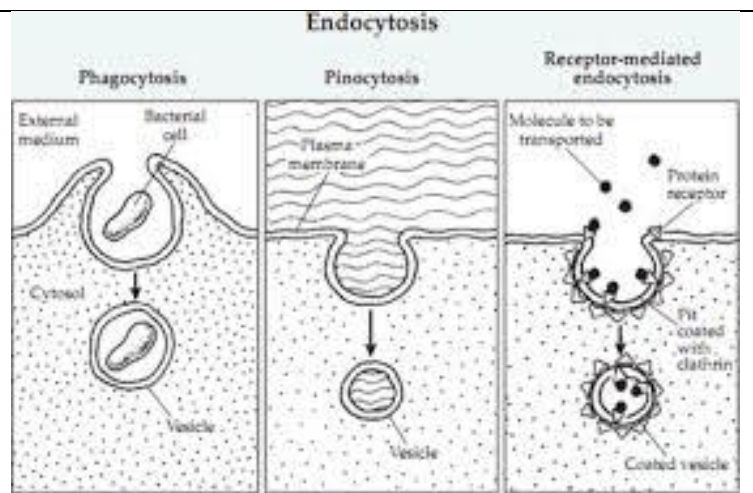

Phagocytosis (cellular eating)

This is called cellular eating and it involves the cell taking in large solid substances. Phagocytosis involves invagination of cell membrane, forming a cup-shaped depression, surrounding the organism or particle forming a phagocytotic vesicle or vacuole which pinches off the cell membrane and moves into the cytoplasm. Lysosomes fuse with vacuoles and release hydrolytic enzymes into the vacuole which break down the substances in the vacuole. The protein substances are absorbed into the surrounding cytoplasm across the lining of the vacuole. Any undigested material may be got rid of by the vesicles of vacuoles moving into the cell surface membrane and fusing with it.

Cells specialised for phagocytosis are called phagocytes and are said to be phagocytic, as in white blood cells and amoeba.

Mechanism of phagocytotic killing by white blood cells

The engulfing cells detect chemo-active molecules (usually small peptide molecules) released by the target matter, and respond by moving towards it. White blood cells form cytoplasmic extensions to form pseudopodia which surround and engulf micro-organisms. The microorganisms attach onto the white blood cell by some 'lock and key' mechanism involving receptor proteins on the cell surface membrane.

Micro-organisms are completely surrounded by pseudopodia due to the activation of the contractile processes of the cell's cytoskeleton. These proteins react with ATP to form phagocytotic vesicles or phagosomes which pinch off the cell membrane into the cytoplasm. The phagosome fuses with the lysosome to form a phagolysosome. Inside the phagolysosome are microbes which are broken down by hydrolytic enzymes

[Clegg and Mackean Pg 240 fg 11.23]

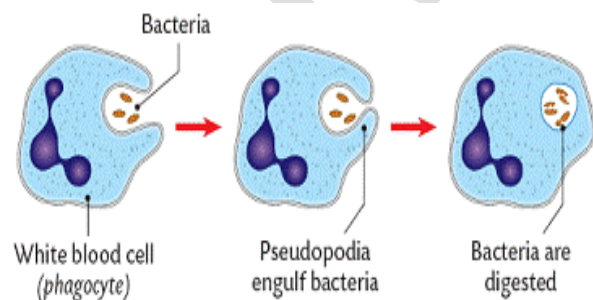

Pinocytosis (cellular drinking)

Pinocytosis is the process by which the cells takes in bulk liquid material. It is also called cellular drinking, it is similar to phagocytosis only that the infoldings forming the vesicles are much smaller.

Liquid and large macro molecules such as proteins are taken in via small pinocytotic vesicles. Smaller pinocytotic vesicles may be formed, in which case the process is called micro-pinocytosis. The process is highly specific involving the binding of the molecules with corresponding receptor molecules in the plasma membrane.

BS page 147

A summary of the role of the plasma membrane in endocytosis and exocytosis

UNEB 2012

Receptor mediated endocytosis

This involves receptor molecules on a cell membrane which binds with specific substance from extracellular fluid i.e. it is selective.

The receptor proteins are usually already clustered in regions of the membrane called **coated pits**.

Extracellular substances (**ligands**) bind to these receptors (a ligand is a molecule that binds specifically to a receptor site of another molecule). As the receptor sites are filled, the surface folds inwards until the coated vesicles finally separates from the cell surface membrane forming a coated vesicle containing ligand molecules. After ingested material is liberated from the vesicle, the receptors are recycled to the plasma membrane by the same vesicle.

Illustration (M. Kent pg 71)

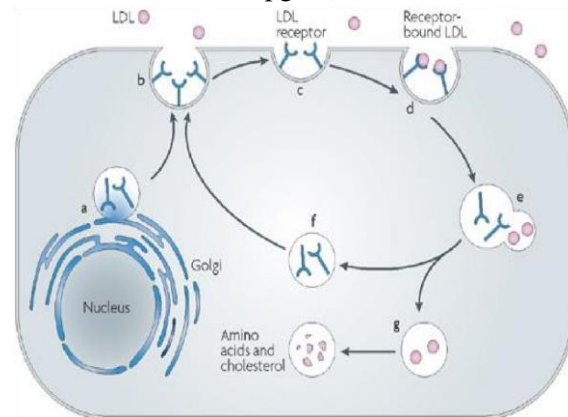

One common example is the binding of cholesterol molecules to specific receptor proteins on the plasma membrane triggers the inward folding of the cell membrane. A vesicle is formed that carries the cholesterol molecule into the cell.

Exocytosis

This involves the vesicles or vacuoles moving to the cell membrane fusing with the releasing their contents to the outside of the cell.

Exocytosis provides a means by which enzymes, hydrochloric acid in the gastric glands, hormones in the various ductless glands, antibodies, sweat-secreting cells of sweat glands of human skin, and cell wall precursors are released from the cell.

The vesicles are often derived from the Golgi apparatus or endoplasmic reticulum, which move along microtubules of the cytoskeleton of the plasma membrane. When the vesicles get into contact with the plasma membrane, the lipid molecules of the two bilayers rearrange and diffuse. The content of the vesicles spill to the outside of the cell and the vesicle membrane becomes part of the plasma membrane

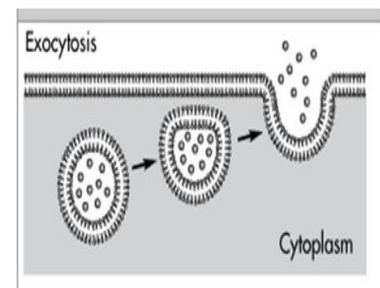

Note: Vesicle and food vacuole formation are active processes, which require energy from respiration.

Importance of cytosol

1. Many secretory cells use exocytosis to release their excretory products outside themselves e.g. pancreatic cells manufacture insulin and secrete it into blood by exocytosis and many other hormones are secreted in this form by the gland cells
2. Exocytosis facilitates synaptic transmission during which neuro-transmitter substances like acetylcholine in synaptic vesicles of synaptic knobs fuse with the pre-synaptic membrane to release neuro transmitter substances into the synaptic cleft of the synapse.
3. Exocytosis delivers cell wall materials to the outside of the cell from the Golgi apparatus/body through vesicles which contain proteins and certain carbohydrates
4. Exocytosis leads to replenishment of the plasma membrane as the vesicle membrane become part of the plasma membrane after spilling/discharging their contents to the outside.

Summary			
Features	Simple diffusion	Facilitated diffusion	Active transport
Concentration gradient	Down the concentration gradient from high to low	Down the concentration gradient from high to low	Against a concentration gradient from low to high
Energy expenditure	None	None	Energy expenditure is in the form of ATP
Carrier protein/ transporter	Not required	Required	Required
Speed	Slowest mode	Fast	Fastest

SAMPLE QUESTIONS

1. The table below shows results of an experiment to determine the solute potential of onion epidermal cells using incipient plasmolysis method. In each case, the total number of cells observed in one field of view was eighty (80).

Concentration of sucrose solution (mol /dm³)	Number of cells plasmolysed	Percentage plasmolysis
0.1	0	
0.2	0	
0.3	2	
0.4	3	
0.45	10	
0.50	60	
0.55	80	
0.60	80	

- (a) Copy and complete the table by working out the percentage of cells which are plasmolysed. (04 marks)
- (b) What is meant by the terms?
 (i) Solute potential. (03 marks)
 (ii) Incipient plasmolysis. (03 marks)
- (c) (i) Plot a graph to show the relationship between percentage of plasmolysed cells and sucrose concentration. (08 marks)
 (ii) From the graph, determine the concentration of the onion epidermal cells to be used to determine their solute potential. (02 marks)
 (iii) Briefly explain how you arrived at your answer in (c) (ii) above. (08 marks)
- (d) Explain the ecological significance of osmosis to plants. (06 marks)
2. (a) (i) Define the term active transport. (02 marks)
 (ii) Describe the sodium-potassium pump as an example of active transport. (07 marks)
- (b) Define the terms uniport carrier, symport carrier and antiport carrier. (06 marks)
- (c) With an example, explain the process of cotransport. (05 marks)
3. An experiment was carried out with cells of the carrot tissue which was first thoroughly washed in pure water. The slices of carrot tissue were immersed in aerated potassium chloride solution of known concentration at varying temperatures. At the fourth hour, the carrot tissue at 25^oC was treated with potassium cyanide. The results are shown in the table below.

Time in minutes	Potassium ion uptake in mg g ⁻¹
-----------------	--

	At 2 ⁰ C	At 25 ⁰ C
0	0	0
60	90	170
120	105	360
240	130	480
300	130	500
360	130	50

- (a). Represent the above data graphically. [6marks]
 - (b). Describe the changes in the rate of potassium ions absorption within the first four hours at 25⁰C. [3marks]
 - (c). During the first hour, some potassium ions enter the carrot cells passively. Suggest any two possible means of their movement and any two conditions needed for one of them to occur. [4marks]
 - (d).
 - (i). Calculate using minutes, the mean rate of absorption of potassium ions at 25⁰C between the 2nd and 6th hour [3marks]
 - (ii). Compare the rates of absorption of potassium ions at 2⁰C and 25⁰C during the experiment. [4marks]
 - (iii). Suggest an explanation for the differences of potassium at the two temperatures. [6marks]
 - (e). Explain the effects of treating the carrot with potassium cyanide on the rate of their absorption of potassium ions. [4marks]
 - (f). Suggest
 - (i). the aim of the experiment. [1mark]
 - (ii). why the carrot tissue was first washed in pure water [2marks]
 - (iii). why the potassium chloride solution was aerated. [2marks]
 - (g). Briefly explain the significance of the existence of the casparian strip within endodermal cells of the root. [5marks]
4. **Figure 1** shows changes in the different potentials of a fully plasmolysed plant cell placed in a hypotonic solution.
Figure 2 shows the rate of movement of two different substances across a phospholipid membrane; glucose by facilitated diffusion and water by simple diffusion, at varying extracellular concentration.

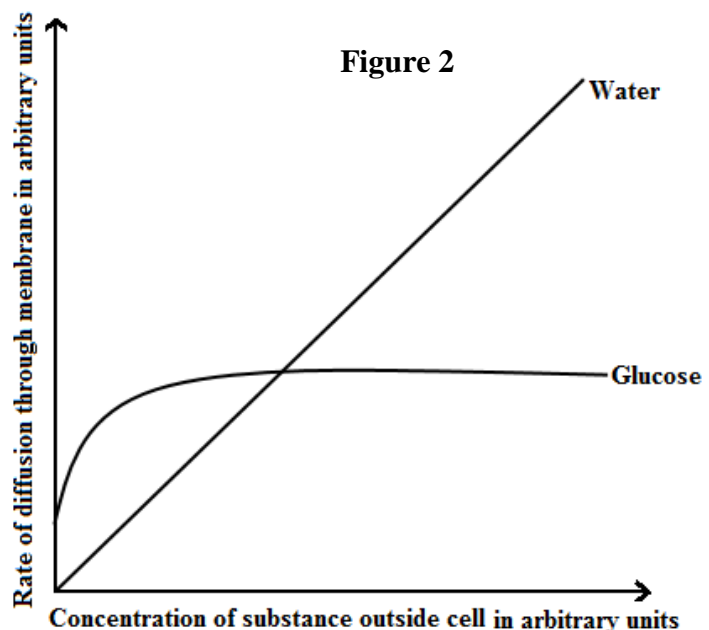
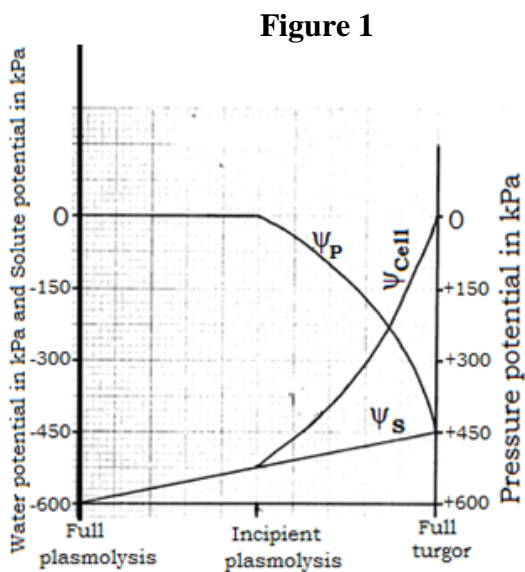

- (a) From **figure 1**, compare the changes in pressure potential and water potential from full plasmolysis to full turgor. (05 marks)
- (b) As indicated in **figure 1**, explain the change in water potential from full plasmolysis to full turgor. (15 marks)
- (c) From **figure 2**, describe the effect of increasing extracellular concentration:
- (i) on glucose uptake. (07 marks)
- (ii) on water uptake (05 marks)
- (d) Explain the observed rates of uptake of glucose and water, from figure 2 above. (08 marks)
5. The graph below shows the effect of concentration difference on three transport processes of molecules or ions across a cell surface membrane. Study the information and answer the questions that follow.

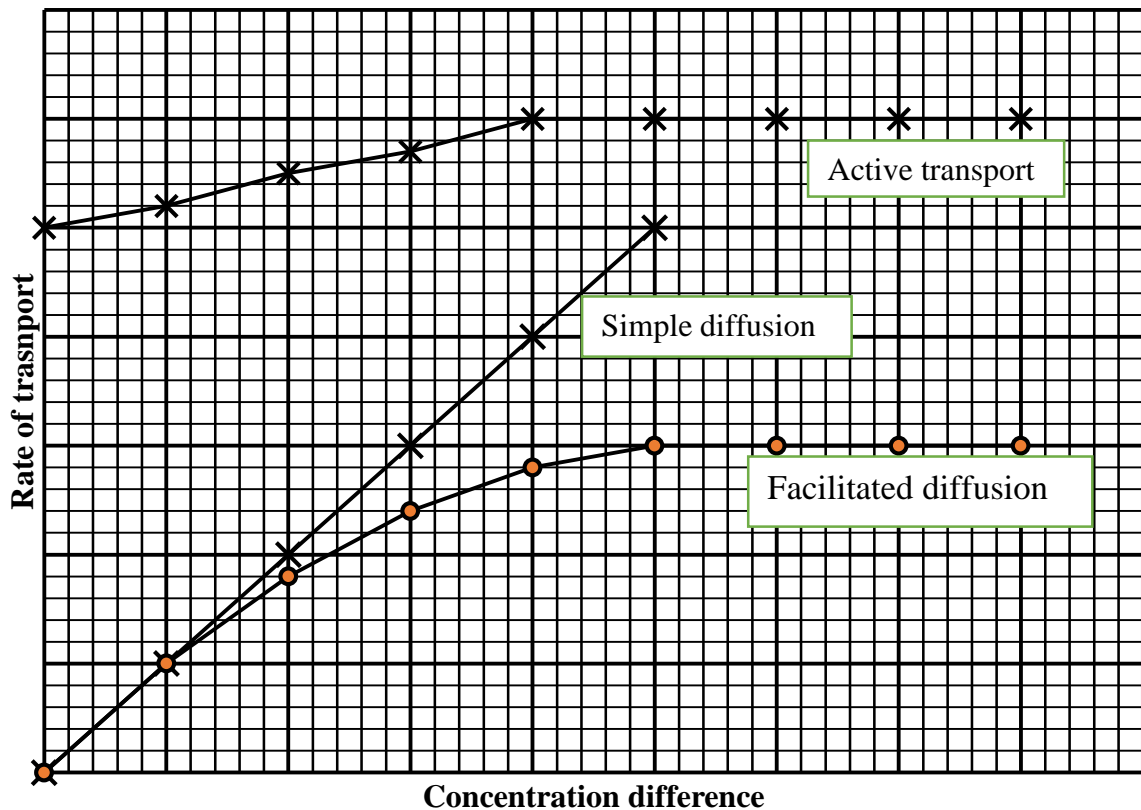

- a) From the graph;
- (i) state **one** similarity between the three transport processes (02 marks)
- (ii) compare the rate of transport by facilitated diffusion and active transport (05)
- (iii) explain the rates of transport observed when the concentration difference is zero (04 marks)
- (iv) explain the changes in the rate of transport by facilitated diffusion (10 marks)
- (v) what is the basis of the difference in the graphs for simple diffusion and facilitated diffusion (02 marks)
- b) (i) Which **one** of the processes would stop if a respiratory inhibitor was added? (01)
- (ii) Explain your answer in b (i) above (03 marks)
- c) Outline the differences between the functioning of carrier proteins in facilitated diffusion and those in active transport (04 marks)
- d) Describe the sodium potassium pump as an example of active transport (09 marks)
- e) state the composition and major function of the animal's cell surface.(03 marks)
6. Two investigations concerning movement of substances in and out of cells were carried out in 2 different organisms and results were summarized in tables 1 and 2 as indicated below.

The first investigation had 2 experiments. In the first experiment the marine ciliate *corthurnia* was placed in a series of dilutions of sea water and the output of its contractile vacuole was measured. In another experiment, the change in volume of the organism in different dilution of sea water was recorded.

Added fresh water/%	0	10	20	30	40	50	60	70	80	90
Contractile vacuole out put/dm³s⁻¹	0.7	0.6	1.1	1.0	1.5	2.4	6.3	18.2	35.1	9.5
Relative body volume	1.0	1.1	1.2	1.3	1.4	1.6	1.8	2.0	2.1	2.0

In the second investigation, the relative rate of uptake of glucose and xylose (a pentose) from living intestine and from intestine which had been poisoned with cyanide, was determined and results recorded in table 2

Sugar	Without cyanide	With cyanide
Glucose	100	28
xylose	18	18

- a) Represent graphically the results in table 1 using a single set of axes (06 marks)
 - bi) Explain the effects of dilutions on the activity of the contractile vacuole(04 arks)
 - ii) what do changes in relative body volume indicate about the effect of the contractile vacuole activity?
 - c) Some species of marine protozoa form contractile vacuoles only the protozoan begins to feed . Suggest an explanation for this observation. (03 marks)
 - d) How is active transport:
 - i) similar to facilitated diffusion (02 marks)
 - ii) different from facilitated diffusion (03 marks)
 - e) Explain the relative uptake of the sugars by the intestines (05 marks)
 - f) How do the following factors affect the rate of diffusion across a membrane
 - i) concentration difference, (02 marks)
 - ii) the size of the molecules(02 marks)
 - iii) temperature (02 marks)
 - iv) polarity of the molecules(02 marks)
7. In an experiment a set of young cereal roots were washed thoroughly in pure water and transferred into culture solutions containing potassium chloride solution under varying oxygen concentrations (at point **M** on the graph below). After 160 minutes solution of unknown substance was introduced (at point **N** on the graph below). The rate of oxygen uptake and potassium chloride uptake were measured and recorded graphically as shown in the figure below.

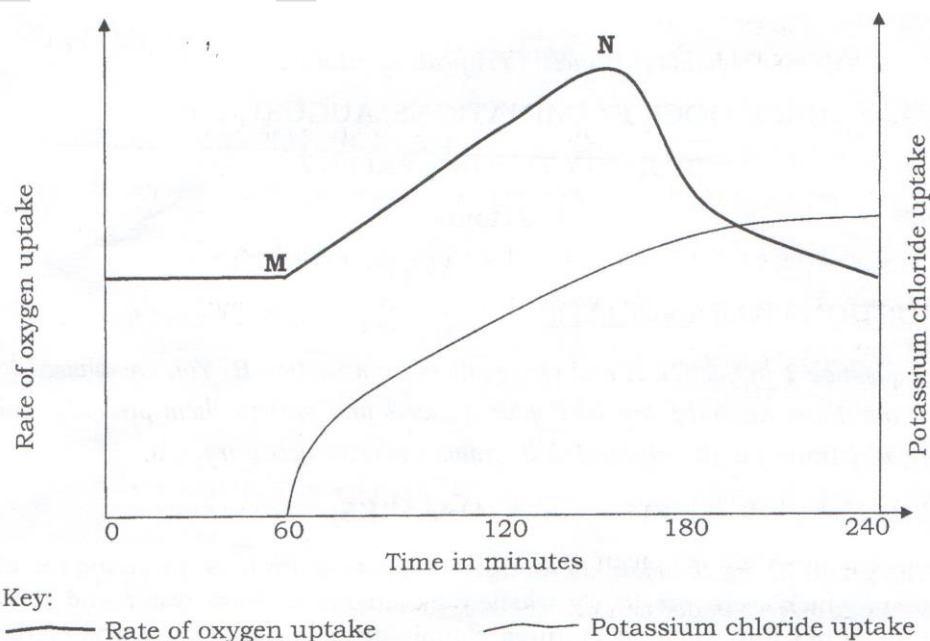

- a) Compare the rate of oxygen uptake with the rate of chloride uptake between 60 and 240 minutes. (04 marks)
- b) Explain the rate of oxygen and potassium chloride uptake as shown in the graph above? (06 marks)
8. The graph below shows the percentage change in length of cylinders of potato which had been placed in sucrose solutions of different concentrations for 12 hours.

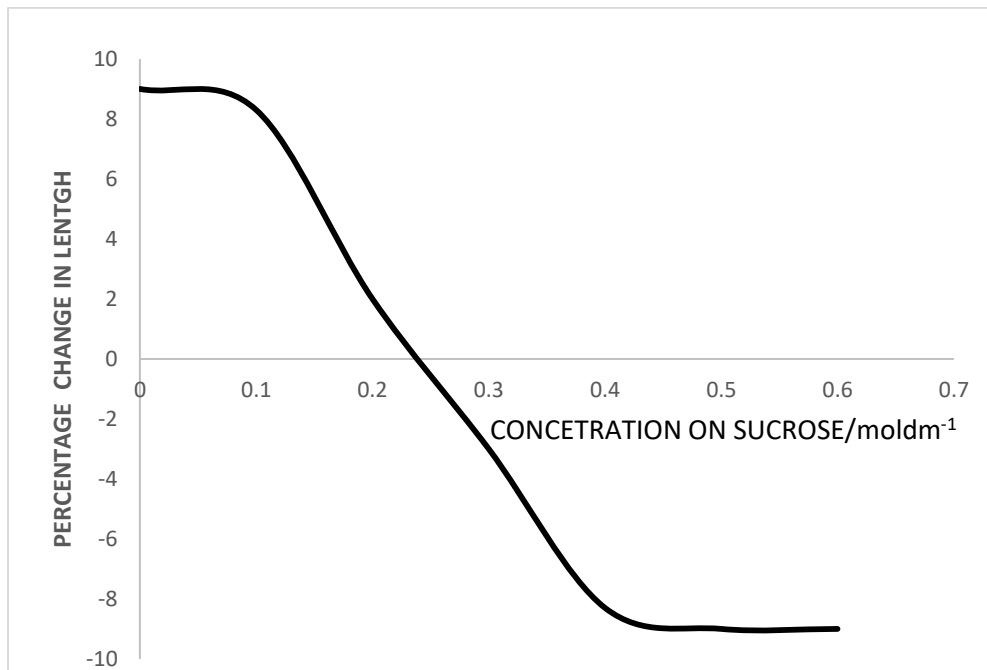

- a) What is meant by the term **water potential**? (02 marks)
- b) In terms of water potential, explain the change in length which occurred when the cylinder of potato was placed in a sucrose solution of concentration of 0.3 mol dm⁻¹
- c) With a reason, state the concentration of sucrose in the potato tubers used in the experiment above (03 marks)

Potato tubers store starch. As they start to grow or sprout, some of this starch is converted to sugars. Sketch a graph on the one plotted above to represent the changes in length you would expect if the investigation had been carried out with sprouting potatoes

9. Define the term **facilitated diffusion**

- c) State **three** ways how facilitated diffusion differs from simple diffusion
- d) Describe **one** way how facilitated diffusion occurs across membranes
- e) State **two** ways how the action of carrier proteins is similar to that of enzymes

10. State the parameters listed in **Fick's law** of diffusion (03 marks)

- b) Explain how each parameter in **Fick's law** of diffusion is reflected in the structure of the mammalian lung
- c) Explain the changes in oxygen delivery to the tissues that occur as a person proceeds from a resting state to intense exercise (04 marks)

11. The table below shows the results of an experiment on the rate of absorption of sugars by a mammalian intestine. Study it carefully and answer the questions that follow.

Sugar	Relative rates of absorption taking normal glucose uptake as 100	
	By living intestine	By intestine poisoned with cyanide

Hexose sugars	Glucose	100	30
	Galactose	106	35
Pentose sugars	Xylose	32	32
	Arabinose	30	31

- (a) Suggest a reason for the difference between the rates of absorption of hexose and pentose sugars in the living intestines (03 marks)
- (b) Mention the mechanism by which hexose sugars are absorbed by living intestines (0 $\frac{1}{2}$ mark)
- (c) What is the advantage to the individual of having hexose sugars absorbed in the way mentioned above?
- (d) What could be the effect of cyanide on the mechanism of hexose absorption? (02 marks)
- (e) In an intact mammal, absorption of fatty acids is drastically curtailed by any clinical condition which leads to a reduction in bile salt excretion or release. Explain why this is so.
12. Beet root cells contain a pigment that cannot normally escape from the cells through the cell surface membrane. The graph below shows the results of an investigation into the effect of temperature on the permeability of the cell surface membrane of beet root cells. The permeability was measured by using a calorimeter to measure the absorbance of green light by the solution in which samples of beet root had been immersed. The greater the absorbance, the more red pigment had leaved out of the beet root cells.

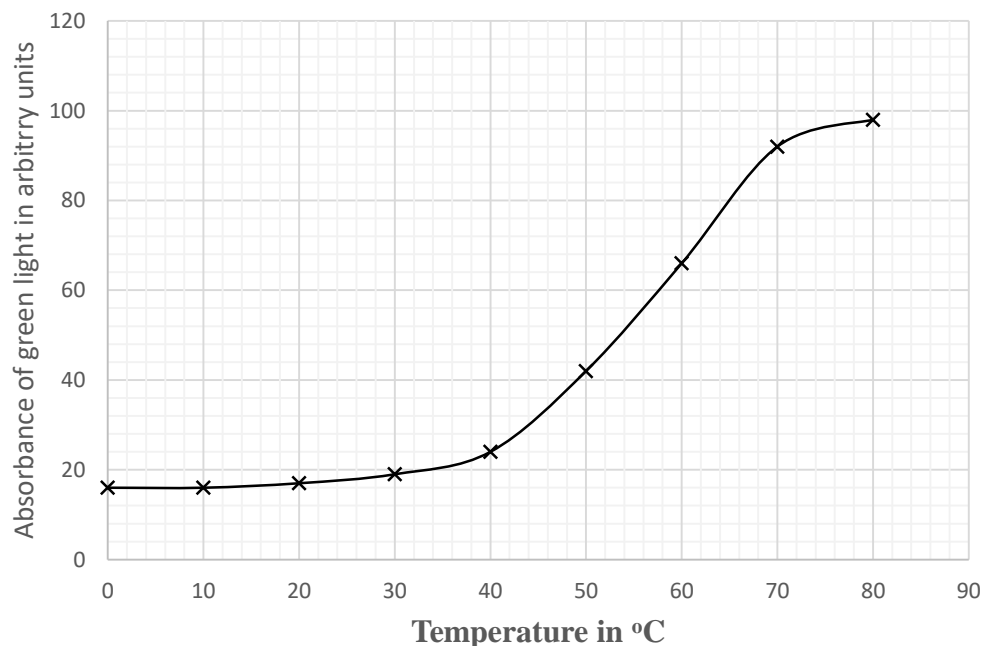

- (a) Describe the changes in the absorbance of green light with temperature. (4 marks)
- (b) What is the general effect of temperature on the absorbance of light? (1 mark)
- (c) With reference to the structure of cell membranes, explain the effect of temperature on absorbance. (4 m)
- (d) State one other way in which membrane permeability could be altered. (1 mark)
13. In a physiological investigation, screened red blood cells were placed in different concentrations of aqueous sodium chloride solution. In each case an average total of five thousand (5000) cells were viewed and the total number of haemolysed cells recorded. The results of this investigation are shown in the table below.

Sodium chloride concentration (g /100ml)	0.33	0.36	0.38	0.39	0.42	0.44	0.48
Number of cells haemolysed	4900	4500	4000	3400	1500	800	100
Percentage cells haemolysed/ %							

(a) (i) calculate the percentage cells haemolysed at each sodium chloride Concentration using the formula below and fill in the table. (3½ marks)

$$\text{Percentage cells haemolysed} = \frac{\text{Number of cells haemolysed}}{\text{average total cells viewed (5000)}} \times 1000$$

- (b) Plot a graph to show variation of percentage cells haemolysed with sodium chloride Concentration.
- (c) Describe the changes in the percentage cells haemolysed. (04 marks)
- (d) Explain the shape of the graph. (06 marks)
- (e) From the graph, determine the sodium chloride concentration:
 - (i) At which 100% haemolysis occurs.
 - (ii) Isotonic to the red blood cells and explain your answer. (04 marks)
- (f) Suggest what would happen if the red blood cells were placed in sodium chloride Concentration of
 - (i) 0.6g/100ml
 - (ii) 0.1g/100ml (04 marks)
- (g) Give reasons why the red blood cells haemolyse over a wide range of salt concentration. (03 marks)
- (h) Briefly describe five ways by which green plants obtain Nitrogen. (08 marks)

14. In an experiment, the rate of uptake of glucose by the blood using simple and facilitated diffusion at varying extracellular concentration of glucose, was measured. The results are shown in the table below. Study the information and answer the questions that follow.

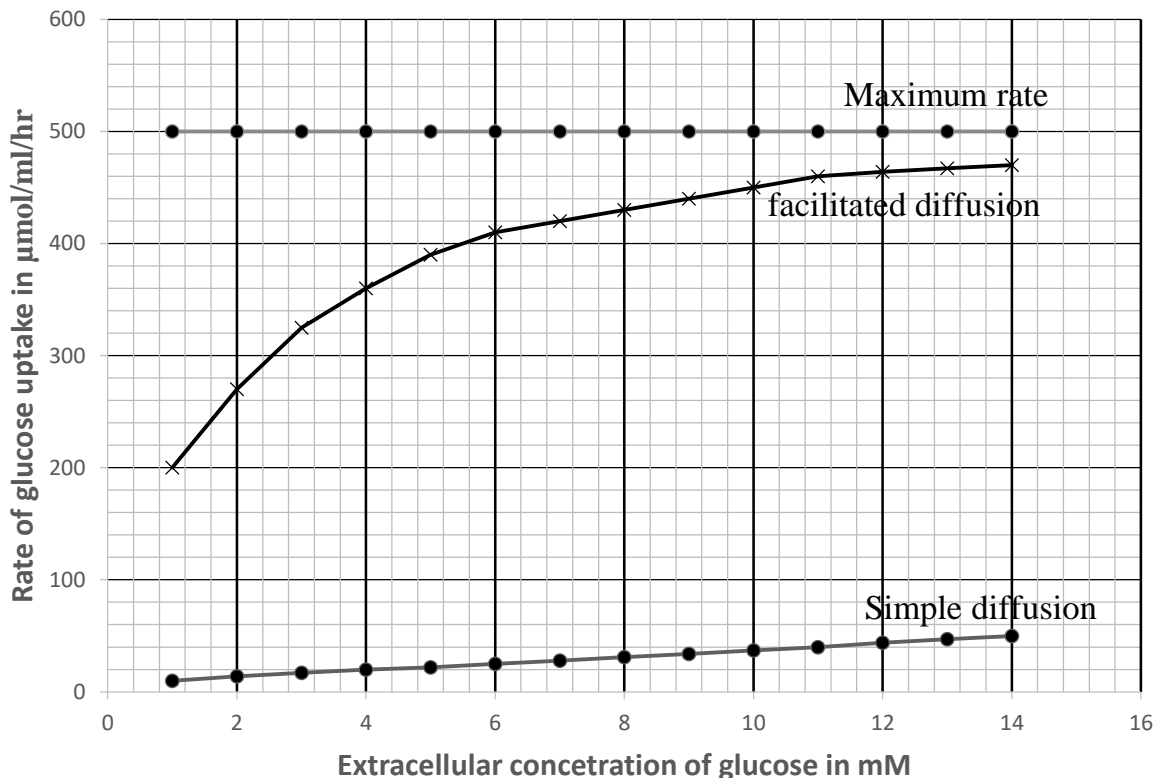

- a) Describe the rate of glucose uptake with increasing extracellular concentration when diffusion is facilitated. (09 marks)
- b) Compare the rate of glucose uptake when diffusion is facilitated and when it is not. (08 marks)

- c) Explain the effect of increasing extracellular concentration of glucose on the uptake of glucose, when diffusion is facilitated. (09 marks)
- d) Suggest what would happen to the rate of glucose if a respiratory poison was introduced into the cell membrane. Give an explanation for your answer. (03 marks)
- e) Explain why:
- Facilitated diffusion occurs (06 marks)
 - The cell membrane is able to carry out facilitated diffusion (12 marks)

REFERENCES

- D.T.Taylor, N.P.O. Green, G.W. Stout and **R. Soper**. Biological Science, 3rd edition, Cambridge University Press
- M.B.V.**Roberts**, Biology a Functional approach, 4th edition, Nelson
- C.J.Clegg with D.G.Mackean, ADVANCED BIOLOGY PRICIPLES AND APPLICATIONS, 2nd EDITION, HODDER EDUCATION
- Glenn and Susan **Toole**, NEW UNDERSTANDING BIOLOGY for advanced level, 2nd edition, Nelson thornes
- Michael **Kent**, Advanced BIOLOGY, OXFORD UNIVERSITY PRESS
- Michael Roberts, Michael Reiss and Grace **Monger**, ADVANCED BIOLOGY
- J.SIMPKINS & J.I.WILLIAMS. ADVANCED BIOLOGY

TOPIC 6: TRANSPORT IN LIVING ORGANISMS

Syllabus extract

Specific objectives: The learner should be able to:	Content
<p><i>Necessary for transport systems</i></p> <ul style="list-style-type: none"> Explain the limitation of simple diffusion in the transport process. 	<ul style="list-style-type: none"> Limitations of simple diffusion process: concept of surface area: volume ratio and its effect on diffusion rate.
<p><i>Water as a medium in plants and animals</i></p> <ul style="list-style-type: none"> Explain the significance of water in transport. 	<ul style="list-style-type: none"> Significance of water in transport: solvent medium of transport
<p><i>Circulatory systems in animals</i></p> <ul style="list-style-type: none"> Describe the circulatory systems in insects, annelids and mammals. Compare the structure and function of veins arteries and capillaries. Describe types of circulatory system Explain the advantages and disadvantages of open and closed systems in animals. Compare the circulatory systems of fish and mammals. Describe the functioning of the mammalian heart. Explain the response of the heart to body activities. Interpret information on the effects of drugs and variation of temperature on the cardiac frequency. Explain how the heart beat rate is controlled. Relate the action of adrenalin and acetylcholine to the innervations of the heart Describe the role of blood components in the transport process. Explain the diseases related to the circulatory system. 	<ul style="list-style-type: none"> Circulatory systems in insects, annelids and mammals. Types of circulatory systems: open and closed, single and double. Advantages and disadvantages of open and closed systems in animals. Structure of transport systems in fish and mammals. Functioning of the mammalian heart: cardiac cycle blood pressure changes, myogenic, myogenic property, control of the heartbeat. Response of heart to body activities Effects of drugs and temperature variations on the cardiac frequency. Action of adrenalin and acetylcholine on the innervation of the heart. Blood constituents and functions. Common diseases of the blood and heart, including sickle cell anaemia and coronary artery diseases. Control of heart beat rate.
<p><i>Circulatory systems in animals practical</i></p> <ul style="list-style-type: none"> Identify structural features of blood vessels. Display and draw major structures of the circulatory systems in insects, toads and mammals. Describe the insects, toad and mammals circulatory system in relation to their functions. 	<ul style="list-style-type: none"> Structure of blood vessels (veins, arteries capillaries). Circulatory systems in insects, toads and mammals gross structure and fine structure. Insect, toads and mammals circulatory systems in relation to functions. Structural adaptation of cardiac muscle and smooth muscle of the circulatory system of mammals.
<p><i>Defence against diseases</i></p> <ul style="list-style-type: none"> Describe the mechanism of blood clotting. Describe immune responses in humans. State the role of the thymus gland in immunity. 	<ul style="list-style-type: none"> Mechanism of blood clotting Immune response in humans: definition, primary secondary). The role of the thymus gland in immunity. Blood transfusion and blood groups.

<ul style="list-style-type: none"> • Explain the immune responses during blood transfusion. • Describe the effects of the Rhesus factor 	<ul style="list-style-type: none"> • Effect of the Rhesus factor during pregnancy.
<p><i>Vascular system of flowering plants</i></p> <ul style="list-style-type: none"> • Describe the structural and functional adoption of the vascular tissues to transport process of materials in monocotyledonous and dicotyledonous plants. • Explain the mechanism of transporting materials in plants. • Describe the evidence for the path of materials in plants. • Describe translocation and uptake of water and mineral salts in plants • Explain the role of transpiration in transport of water and dissolve mineral salts in plants. 	<ul style="list-style-type: none"> • Structure and functional adaptation of vascular tissue in monocotyledonous and dicotyledonous plants. • Mechanism of transporting materials in plants. • Evidence for the path of materials in plants. • Uptake of water and mineral salts in plants. • Role of transpiration in transport of water and dissolved mineral salts in plants.
<p><i>Vascular system of flowering plants. Practical</i></p> <ul style="list-style-type: none"> • Identify types and the pattern of distribution of vascular bundles in the plant organs. • Stain and make temporary mounts of transverse section (T.S) and longitudinal section (L.S) of : stems, roots and T.S of leaves. • Draw and label low power plans to show distribution of issues in T.S and L.S of stems, roots and T.S of leaves. • Make high power labeled drawings of vascular tissues in T.S of leaves. 	<ul style="list-style-type: none"> • Structure and distribution pattern of the vascular tissue in monocotyledon and dicotyledonous plants. • Transverse T.S and longitudinal sections L.S. of stems, roots and T.S of leaves of monocotyledonous and herbaceous dicotyledonous plants. • Labeled diagrams of T.S of stems, root and T.S of leaves.

Need for a transport system

Many materials including oxygen, carbon dioxide, soluble food substances, hormones, urea e.t.c. need to be transported from one point to another using a transport network and medium.

The transport system in animals is mainly made up of blood vessels consisting of blood as the medium circulating through them to the various body tissues. The transport system is also made up of the pump i.e. the heart which brings about circulation of blood throughout the body, by pumping it. The transport system is also composed of the lymph vessels containing the lymph fluid.

The larger, compact and more active an organism is, the more the need for a transport system due to a small surface area to volume ratio which reduces the rate of diffusion of materials from the body surface to the cells in the middle of the organism. There are however some organisms which lack the transport system e.g. protozoa and platyhelminthes e.t.c. This is because, being small in size and being flattened in shape gives these animals a large surface area to volume ratio, this enables free and rapid diffusion of materials from one part of the body to another. Consequently large multi-cellular organisms have an elaborate transport system that carries useful substances such as oxygen and glucose to the cells and carries away the waste products of metabolism. An elaborate transport system has two major features;

- a. An increased surface area of the sites of exchange of materials. Such sites include the lungs and the gills where oxygen is absorbed and the villi of the ileum where food nutrients are absorbed along the alimentary canal.
- b. A system whereby the circulating medium carries the absorbed substances at a faster rate than diffusion. In some organisms with a blood circulating system, blood flow is not confined to blood vessels but instead it flows within a blood filled cavity called *Haemocoel* e.g. in arthropods and molluscs. In other organisms with the blood circulatory system, blood flow is confined to blood vessels only e.g. in vertebrates and some invertebrates such as the earth worm.

Importances of a blood circulatory system (functions of blood)

1. Tissue respiration. It enhances the formation of energy in the tissues by transporting oxygen and soluble food substances to the tissues to be used as raw materials for respiration. Carbon dioxide is also transported away from the tissues mainly in the form of bicarbonate ions (HCO_3^-) as a by-product of respiration and then taken to the lungs for its removal from the body. Oxygen is transported in the form of oxyhaemoglobin from the respiratory surfaces to the tissues.
2. Hydration. Blood transports water from the gut to all tissues.
3. Nutrition. Blood transports the soluble well digested food materials from the gut to the body tissues.
4. Excretion. Blood transports metabolic waste products from the tissues to the excretory organs for their removal from the body e.g. blood transports urea from the liver to the kidney in order for it to be removed from the body.
5. Temperature regulation. Blood distributes heat from the organs where it is mainly generated e.g. the liver and the muscles, uniformly throughout the body.
6. Maintenance of constant pH. Blood maintains a constant pH through the maintenance of circulation of the plasma proteins manufactured by the liver which act as buffers to maintain the pH of the body fluids constant. This enables enzymes to function efficiently as charges will denature the enzyme.

7. Growth, development and co-ordination. Blood transport different metabolites such as glucose, amino acids and hormones needed for the growth and development of the body.
8. Defence. Blood defends the body against diseases through the following ways;
 - By using some white blood cells (leucocytes) which phagocytotically ingest and destroy pathogens that cause diseases.
 - By formation of a blood clot around the wound so as to prevent entry of microbes or pathogens into the body.
 - By use of the immune response mechanism towards infection e.g. by use of the different types of antibodies to destroy the microbes
 -

BLOOD

This is a highly specialized fluid tissue which consists of different types of cells suspended in a pale yellow fluid known as the blood plasma

Blood plasma

This is a pale yellow fluid component of blood composed of the plasma proteins and blood serum where the blood cells are suspended. Blood plasma carries the biggest percentage of blood and consists of a colourless fluid known as serum and also plasma proteins. It is in the blood serum that all the different soluble materials are dissolved e.g. urea, hormones, soluble food substances, bicarbonate ions e.t.c.

The plasma proteins are manufactured by the liver and include the following;

- a. Fibrinogen. This protein is important for normal blood clotting by changing into fibrin in the presence of thrombin enzyme.

Fibrinogen (soluble) \longrightarrow Fibrin (insoluble)
- b. Prothrombin. This is the inactive form of the proteolytic enzyme, thrombin, used in converting fibrinogen to fibrin during the clotting of blood.
- c. Globulin. Both Prothrombin and globulin play important roles in the homeostasis. All the plasma proteins maintain pH of the body fluids constant by acting as buffers.
- d. Blood cells. There are three main types of blood cells which include;
 - i. Erythrocytes (Red blood cells)
 - ii. Leucocytes (White blood cells)
 - iii. Platelets

ERYTHROCYTES (Red blood cells)

These are small numerous bi-concave disc shaped cells mainly important in transportation of oxygen as oxyhaemoglobin from the respiratory surfaces e.g. lungs and gives it to the tissues as well as transporting carbondioxide from tissues back to lungs. Erythrocytes are manufactured by the bone marrow in adult and by the liver in the foetus.

Note; Erythrocytes have a life span of 120 days.

Diagram showing the shapes of erythrocytes

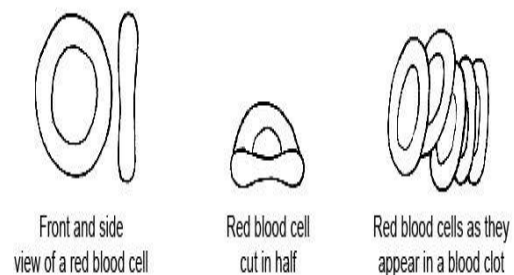

Adaptations of erythrocytes

1. They have a red pigment called haemoglobin in their cytoplasm which has a high affinity for oxygen and therefore rapidly transports oxygen.
2. They have a thin and permeable membrane which enables faster diffusion of oxygen and carbon dioxide into them
3. They have a pliable membrane (flexible membrane) which can enable them change their original shape and squeeze themselves into the blood capillaries in order to allow the exchange of respiratory gases
4. They have an enzyme known as carbonic anhydrase within their cytoplasm which enables most of the carbon dioxide to be transported in form of bicarbonate ions (HCO_3^-), by catalyzing the reactions between carbon dioxide and water to form carbonic acid.

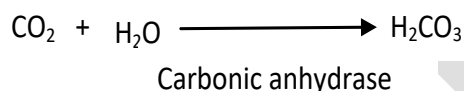

5. They lack a nucleus so as to provide enough space for haemoglobin in order to carry a lot of oxygen in form of oxyhaemoglobin.
6. They have a bi-concave disc shape which provides a large surface area that enhances maximum diffusion of enough oxygen into them.

LEUCOCYTES (white blood cells)

They are amoeboid cells having a nucleus and a colourless cytoplasm important for defense of the body against infections. They are fewer than erythrocytes i.e. they are about $7000/\text{m}^3$ of blood. They are mainly manufactured by the bone marrow. They are classified into two main types which include;

Granulocytes (polymorphonuclear leucocytes)

These are leucocytes with granules in their cytoplasm and a lobed nucleus. They originate in bone marrow. There are three types of granular leucocytes which include;

- i. Basophils (0.5%)
- ii. Eosinophils (1.5%)
- iii. Neutrophils (70%)

Basophils (0.5%) produce *heparin* and *histamine*. Heparin is an anti-coagulant which prevents blood clotting in blood vessels. Histamine is a substance that is released during allergic reactions e.g. hay fever. Histamine brings about allergic reactions by causing dilation (widening) and increased permeability of small blood vessels which results in such symptoms as itching, localized swellings, sneezing, running nose, red eyes e.t.c.

Eosinophils (1.5%) possess anti-histamine properties and their number increases in people with allergic reactions such as high fever, asthma e.t.c. so as to combat the effects of histamine.

Neutrophils (phagocytes) (70%) engulf pathogens phagocytotically and digest them actively inside to defend the body against diseases.

Agranulocytes (mononuclear leucocytes)

These are leucocytes with no granules in their cytoplasm usually with a spherical or bean shaped nucleus. They originate in bone marrow and lymph nodes. They are divided into two types;

- i. Monocytes (4%)
- ii. Lymphocytes (24%)

Monocytes (4%) are leucocytes which enter the tissues from which they develop into macrophages which carry out Phagocytosis to defend the body against pathogens.

They have a bean shaped nucleus.

Lymphocytes (24%) they are produced in the thymus gland and lymph nodes. The precursor cells of lymphocytes in the bone marrow form a tissue which is called the lymphoid tissue. Lymphocytes are usually round and they possess a small quantity of the cytoplasm. Lymphocytes produce antibodies, agglutinins, lysins, opsonins and antitoxins. In adults they are produced and develop in the bone marrow and lymph glands while in embryos they are produced in the thymus gland, liver and spleen.

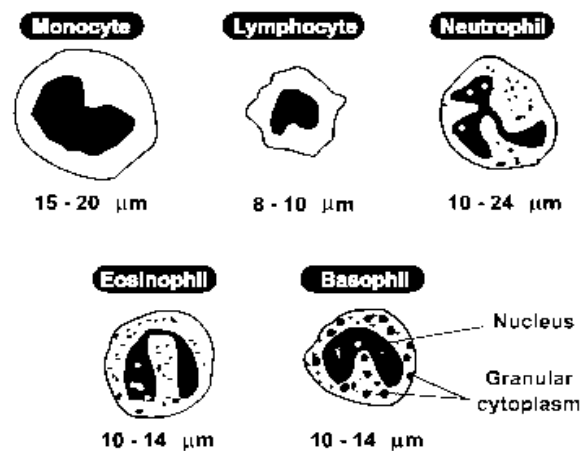

They have a life span of 21 days

Adaptations of white blood cells to their function

- a. They are larger than the pathogens
- b. They are numerous
- c. Some lymphocytes produce antibodies which attack pathogens
- d. They have a sensitive cell surface membrane that detects micro organisms
 - i. They have enzymes in their cytoplasm to digest the engulfed micro organisms
 - ii. They do not have a fixed shape and hence the amoebic movements used to engulf pathogens.
 - iii. They have an irregular shaped nucleus which allows them to squeeze through the narrow capillaries
 - iv. They have a large nucleus which contains many genes for the control of antibody production.

BLOOD PLATELETS (thrombocytes)

These are irregularly shaped, membrane bound cell fragments lacking the nuclei and are formed from the bone marrow cells. They are responsible for starting up the process of blood clotting. There are about 250,000 blood platelets per mm³ of blood.

TRANSPORT OF OXYGEN

The equation below shows how haemoglobin combines with oxygen.

As shown by the equation above, each haem group combines with one oxygen molecule and therefore 1 haemoglobin molecule carries four oxygen molecules.

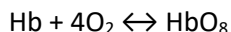

Haemoglobin

Haemoglobin is a large and complex molecule that is composed of four polypeptide chains (therefore it has a quaternary structure) arranged around four haem groups. Two of the polypeptide chains are coiled to form α -helix, and this in turn is folded on itself into a roughly spherical shape, the other two chains are called β -chains due to unique primary structures in both types of chains. Various kinds of chemical bonds, together with electrostatic attraction, keep the folds of the chain together and maintain the shape of the molecule. Haemoglobin is an example of a conjugated protein: attached to the hydrophobic crevice of the polypeptide chain is a flat group of atoms, the prosthetic group, consisting of a central iron atom held by rings of nitrogen atoms, which are part of a large structure known as porphyrin rings

The prosthetic group is haem and it is to the iron atom in the middle of it that the oxygen molecule becomes attached. The presence of four haem groups means that a single molecule of haemoglobin can carry four molecules of oxygen. Haem belongs to a class of organic compounds known as the porphyrins.

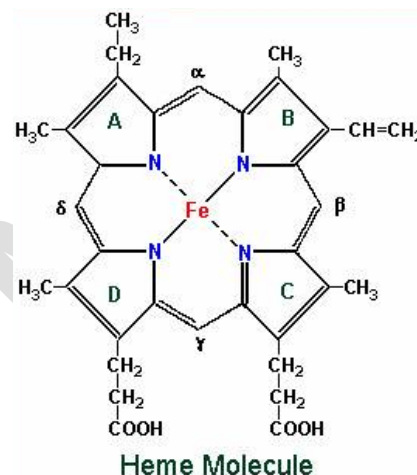

Other oxygen carrying pigments

There are several other groups of blood pigments and they differ mainly in the nature of prosthetic group. Chlorocruorin and haemoerythrin both contain iron, and haemocyanin contain copper. These three pigments are confined to invertebrate groups, particularly annelids and molluscs.

Pigments differ in their oxygen-carrying capacities and are located in different areas

	Haemoglobin	Chlorocruorin (some annelids)	Haemocyanin (snails and crustaceans)	Haemoerythrin (some annelids)
Colour of pigment	Red	Green	Blue	Red
Metal in prosthetic group	Iron	Iron	Copper	Iron
Molecule of oxygen carried per atom metal	1:1	1:1	1:2	1:3
Location in blood	Cells or plasma	Plasma	Plasma	Cells or plasma

Oxygen tension and oxyhaemoglobin formation

The ability of erythrocytes to carry oxygen to the tissues is due to haemoglobin having a high affinity for oxygen i.e. it can readily combine with oxygen and becomes fully saturated with it at relatively low partial pressures of the gas. Partial pressure of a gas is the measure of the concentration of a gas expressed in Kilo Pascals (Kpa) or millimetres of mercury (mmHg)

The high affinity of haemoglobin for oxygen is measured experimentally by determining the percentage saturation of haemoglobin with oxygen. When the percentage saturation of blood with oxygen is plotted against the partial pressure of oxygen an *S-shaped curve* or *sigmoid curve* is obtained and this curve is called the **oxygen dissociation curve** which is shown on the right. The curve indicates that a slight increase in the partial pressure of oxygen leads to a rapid increase in the percentage saturation of haemoglobin with oxygen. This indicates that haemoglobin has a high affinity for oxygen in that it readily combines with it and become saturated with it at low partial pressures of oxygen.

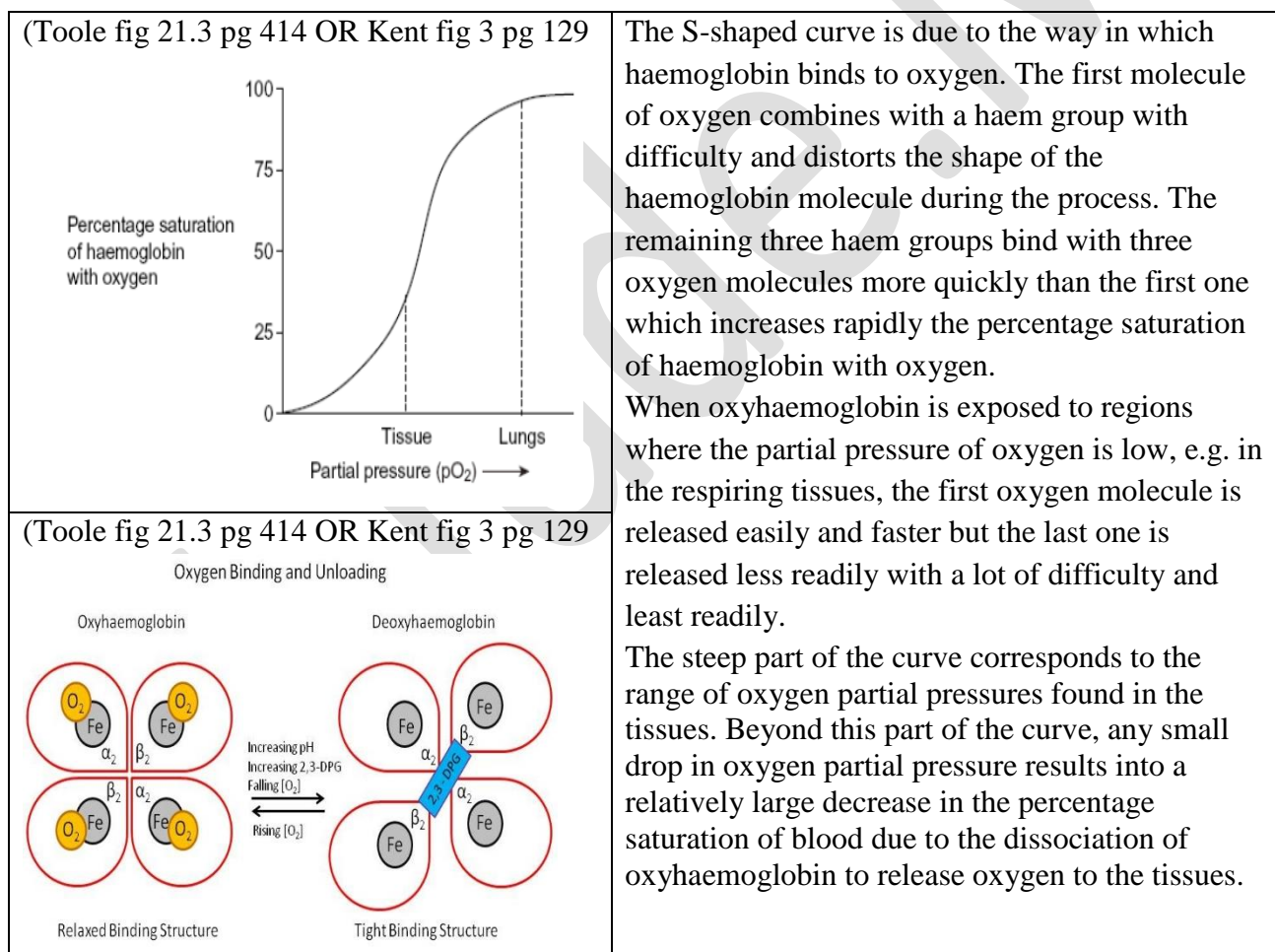

Beyond this part of the curve any small drop in the oxygen partial pressure results into a relatively large decrease in the percentage saturation of blood with oxygen, due to the dissociation of oxyhaemoglobin to release oxygen to the tissues.

In conclusion, the curve indicates that haemoglobin has a high affinity for oxygen where the oxygen tension is high e.g. in the alveolar capillary of the lungs. However, the affinity of haemoglobin for oxygen is lower where the oxygen tension is low and instead it dissociates to release oxygen e.g. in the blood capillaries serving blood to respiring tissues.

The oxygen supply can be distributed according to the requirements of different times, with skeletal muscles getting more during exercise or the intestinal tract getting more during digestion. Of particular importance is the constant flow of blood to the brain. For example, falling during fainting actually prevents serious damage to the brain cells as a result of inadequate blood supply. (These responses are often thwarted by well-meaning bystanders anxious to get the affected individual 'back on his feet'. In fact, holding a fainting person upright can lead to severe shock and even death).

Note: loading tension is the partial pressure of oxygen at which 95% of the pigment is saturated with oxygen, and the unloading tension is the partial pressure at which 50% of the pigment is saturated with oxygen.

Affinity of haemoglobin for oxygen under different conditions				
Region of the body	Oxygen tension (concentration)	Carbon dioxide tension (concentration)	Affinity of haemoglobin for oxygen	Result
Gaseous exchange surface	High	Low	High	Oxygen is absorbed
Respiring tissue	Low	High	Low	Oxygen is released

There are many different oxygen dissociation curves because:

- there are a number of different respiratory pigments
- haemoglobin exist in a number of different forms
- the characteristics of each pigment change under different conditions

The many different oxygen dissociation curves are better understood if two facts are always kept in mind:

- the more to the left the curve is, the more readily the pigment associates with oxygen **but** the less easily its dissociates with it
- the more to the right the curve is, the less readily the pigment associates with oxygen **but** the more easily it dissociates from it

Effect of carbon dioxide on the oxygen dissociation curve (Bohr's effect)

Within tissues there is a high concentration of carbon dioxide produced during aerobic respiration



Increase in carbon dioxide concentration decreases the affinity of haemoglobin for oxygen, by making the pH of the surrounding medium more acidic (low), thereby shifting the oxygen dissociation curve to the right. This shifting of the curve to the right is known as Bohr's effect i.e. the shifting of the oxygen dissociation curve to the right due to the increase in partial pressures of carbon dioxide which results into haemoglobin having a low affinity for oxygen and a high affinity for carbon dioxide.

Bohr's effect may be defined as 'the lowering of the affinity of blood's haemoglobin for oxygen due to increased acidity caused by increase in carbon dioxide concentration'.

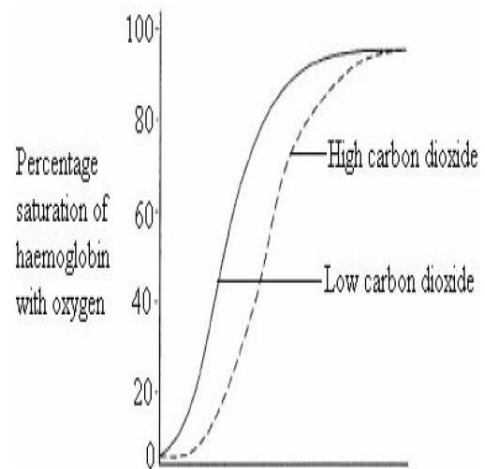
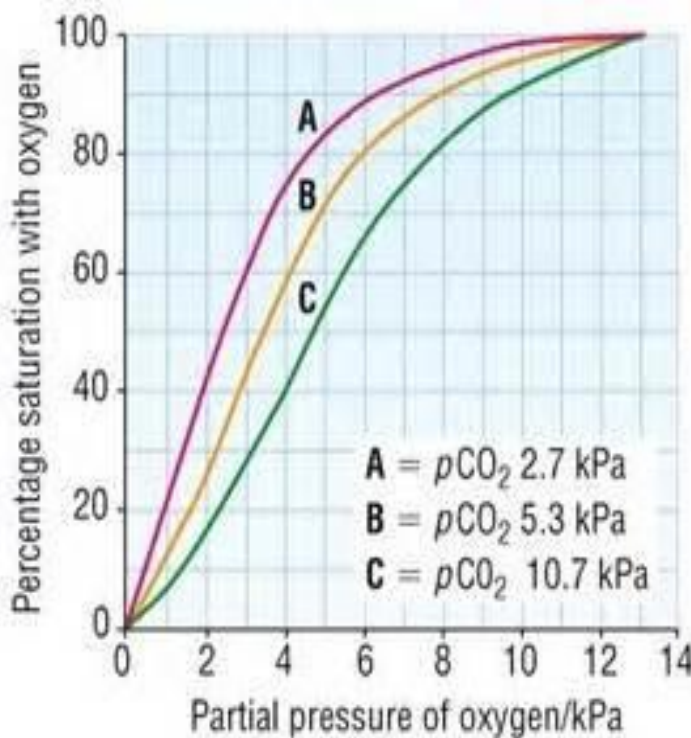

From the dissociation curves above, shifting the oxygen dissociation curve to the left means that haemoglobin has a higher affinity for oxygen and therefore becomes fully saturated with oxygen at very low partial pressures of oxygen.

It also means that haemoglobin has a low rate of dissociation to release oxygen to the tissues but a high rate of combining with oxygen.

Shifting of the oxygen dissociation curve to the right means that haemoglobin has a lower affinity for oxygen and a higher rate of dissociation to release oxygen to the tissues rapidly to support tissue respiration

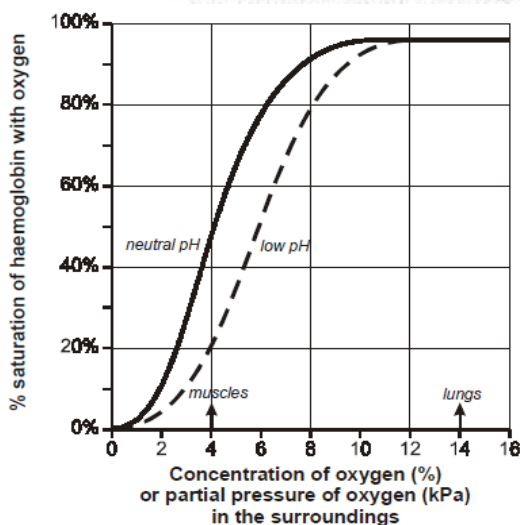

Effect of carbon monoxide on the affinity of haemoglobin for oxygen

There's a loose and reversible reaction between oxygen molecules and iron (II) atoms of haem groups of haemoglobin to form oxyhaemoglobin. This means that iron (II) is not oxidized to iron (III) as haemoglobin combines with oxygen.

In the presence of carbon monoxide and oxygen, haemoglobin combines readily with carbon monoxide to form a permanent compound known as carboxyhaemoglobin rather than combining with oxygen.

A permanent carboxyhaemoglobin compound is formed because carbon monoxide oxidizes iron (II) to iron (III). This reduces the free haemoglobin molecules available to transport oxygen molecules to the tissues, which makes the tissues develop symptoms of anoxia (total lack of oxygen in the tissues).

Therefore, carbon monoxide is referred to as a respiratory poison because it can readily combine with haemoglobin much more than oxygen and the product formed i.e. carboxyhaemoglobin does not dissociate.

Note; smokers have 10% of their total haemoglobin in form of carboxyhaemoglobin.

Myoglobin and other pigments

The oxygen dissociation curves for myoglobin lies to the left of that of haemoglobin as shown in the graph

Myoglobin is a respiratory pigment which also contains iron containing haem groups mostly found in the muscles where it remains fully saturated at partial pressures below that required for haemoglobin to give up its oxygen.

Myoglobin has a higher affinity for oxygen than haemoglobin in a way that it combines readily with haemoglobin and it becomes fully saturated with oxygen at a lower partial pressure of oxygen.

Myoglobin acts as a store of oxygen in resting muscles in form of oxymyoglobin and only releases the oxygen it stores only when oxyhaemoglobin has been exhausted i.e. many vigorous activities because myoglobin has a higher affinity for oxygen than haemoglobin.

(Kent fig 3 pg 131 OR Clegg fig 17.31 pg 360)

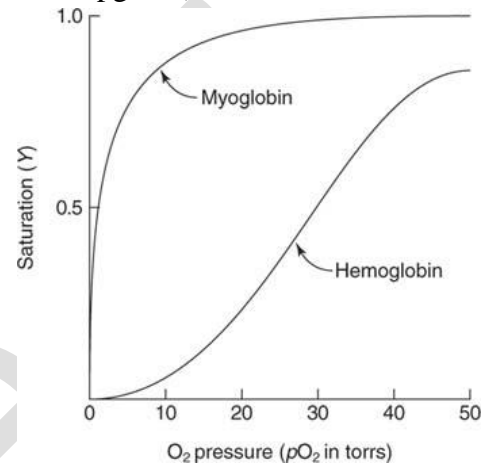

Note;

1. High affinity refers to low rate of dissociation of oxyhaemoglobin to release oxygen and a higher rate of association of haemoglobin with oxygen.
2. Low affinity refers to higher rate of dissociation of oxyhaemoglobin to release oxygen and a lower rate of association of haemoglobin with oxygen.

Comparison between the oxygen dissociation curve for Lugworms' (*Arenicola*) haemoglobin and that of Man

The oxygen dissociation curve of the lugworm's haemoglobin lies on the left of that of man's haemoglobin as shown in the graph below This indicates that the haemoglobin of the lugworm has a higher affinity for oxygen than that of man. This is because the lugworm lives in oxygen deficient mud and so in order to extract enough oxygen from that environment of low oxygen tension, the haemoglobin of the lugworm must have a higher affinity for oxygen than that of man thriving in a well-supplied environment with oxygen.

This implies that the lugworm's haemoglobin dissociates to release oxygen to its tissues compared to that of man which makes the lugworm less active than man, who releases much oxygen rapidly to the tissues.

(Clegg fig 17.32 pg 360 OR Toole fig 21.5 pg 416)

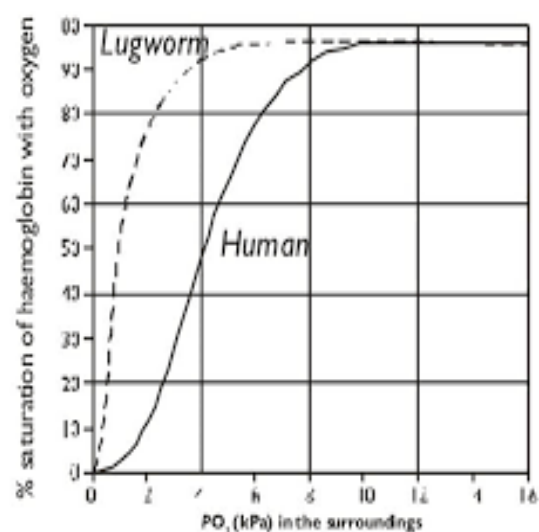

Comparison between the oxygen dissociation curves of different sized mammals

The smaller animal size, the higher the surface area to volume ration. Small animals therefore lose a lot of heat from their surfaces and in order to maintain a constant internal body temperature, they have to produce a lot of heat to compensate for the lost heat. Such animals therefore higher metabolic rates and so need more oxygen per gram of tissue than larger animals. Therefore they have blood that gives up oxygen more readily i.e. their dissociation curves are on the right of the larger animals

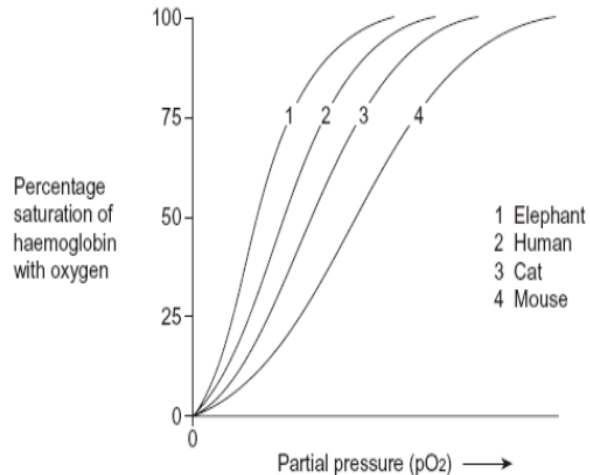

Comparison between the oxygen dissociation curves at rest and during exercise

During exercise, the oxyhaemoglobin releases oxygen more readily hence the oxygen dissociation curve during exercise is to the right of the curve when at rest.

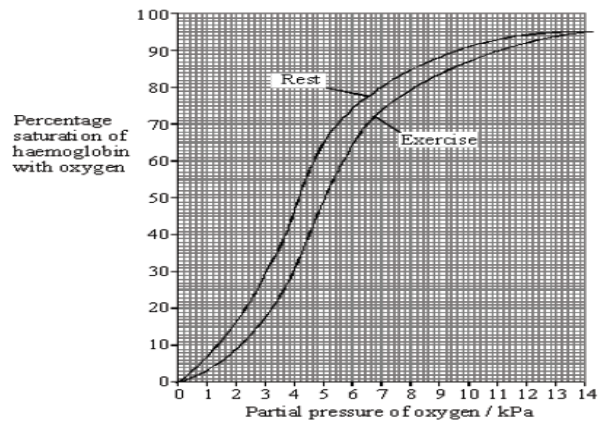

Comparison between the oxygen dissociation curve of maternal haemoglobin and that of the foetal haemoglobin

The oxygen dissociation curve of foetal haemoglobin lies to the left of maternal haemoglobin as shown in the diagram besides; This indicates that the foetal hemoglobin has a higher affinity for oxygen than that of the mother. This enables the foetal haemoglobin to pick sufficient oxygen from the mother via the placenta and also increases on the oxygen carrying capacity to the tissues, especially when the foetus needs a lot of energy. It also increases on the oxygen carrying capacity to the tissues of the foetus in the situation whereby deoxygenated and oxygenated blood are mixed due to the bypasses of ductus arteriosus and foramen ovale in the foetus.

(Clegg fig 17.36 pg 363 OR Toole fig 21.7 pg 416 OR Soper fig 14.32 pg 481)

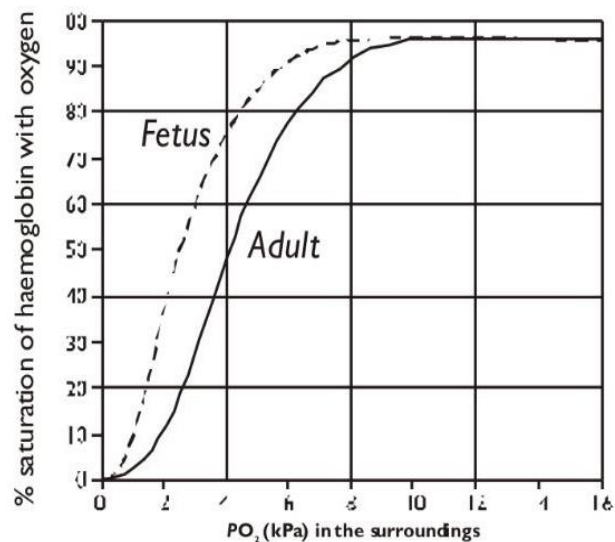

Effect of temperature on haemoglobin oxygen dissociation curve

A rise in temperature lowers the affinity of haemoglobin for oxygen thus causing unloading from the pigment i.e. a rise in temperature increases the rate of dissociation of oxyhaemoglobin to release oxygen to the tissues.

Increased tissue respiration which occurs in the skeletal muscles during exercise generates heat. The subsequent rise in temperature causes the release of extra oxygen from the blood to the tissues. This is so because increase in temperature makes the bonds which combine haemoglobin with oxygen to break, resulting into the dissociation of oxyhaemoglobin.

Oxygen dissociation curve for haemoglobin at different temperatures

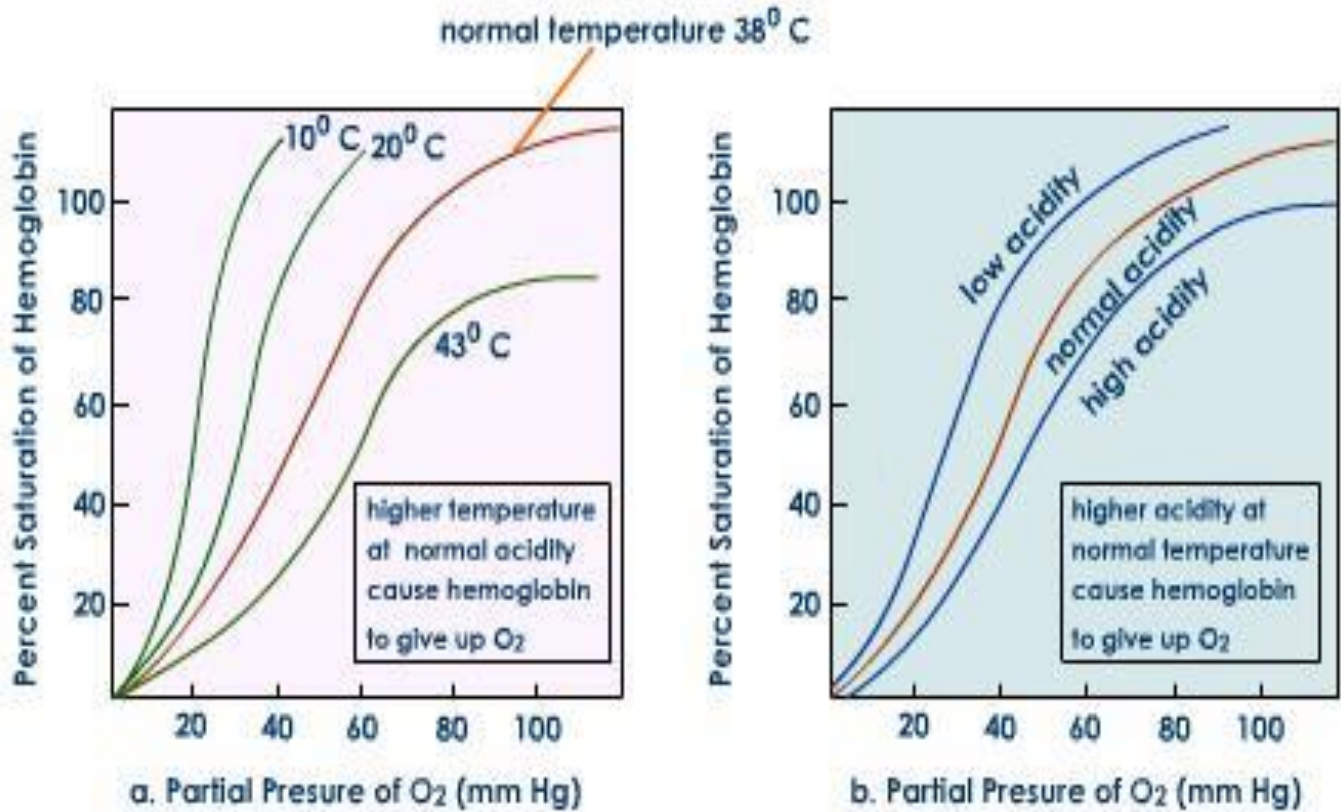

Effect of changing altitude on oxygen carriage

There is a decrease in the partial pressure of oxygen in the atmosphere with increase in altitude from sea level. Therefore the volume of oxygen is less at high altitudes than at sea level. When an organism moves from the sea level to high altitudes, very fast, such an organism tends to develop symptoms of anoxia (lack of oxygen) which include headache, fatigue, nausea, and becoming unconscious. However, when an organism moves slowly from sea level to high altitudes like the mountain climbers, such an organism can at first develop symptoms of anoxia but later on such symptoms disappear due to adjustments in the respiratory and circulatory systems in response to insufficient oxygen reaching the tissues from the surrounding.

The amount of haemoglobin and the red blood cell count increases together with the rate of breathing and the heartbeat. More red blood cell formation occurs in the bone marrow under the control of the hormone called *erythropoietin* secreted by the kidney. Secretion of erythropoietin is stimulated by lower oxygen tension in the tissues. Increase in the amount of haemoglobin and red blood cells together with increase in the breathing rate and heart beat increases the oxygen carrying capacity of the blood to the tissues which leads to the disappearance of the symptoms of anoxia and which also makes the individual organism to be acclimatized.

Acclimatization is therefore a condition whereby an organism carries out a series of physiological adjustments in moving from a low altitude area to a high one to avoid symptoms of anoxia so that such an organism can survive in an environment of low oxygen content.

The graphs below show the oxygen dissociation curves of people living at sea level and at high altitude (Clegg fig 17.37 pg 363 OR Toole fig 21.4 pg 415 OR Soper fig 14.31 pg 481 OR Simpkins fig 8.19 pg 145) The mammals that live in regions of the world beyond the sea level e.g. mountains solve the problem of lack of enough oxygen in the atmosphere by possessing haemoglobin with a higher affinity for oxygen than that of mammals at sea level. This enables the high altitude mammals to obtain enough oxygen through the oxygen deficient environment e.g. the llama. This explain why the oxygen dissociation curve of the haemoglobin of the llama lies to the left of that of other mammals at sea level. The vicuna long necked member of the camel family that stays in the high alpine areas of the Andes

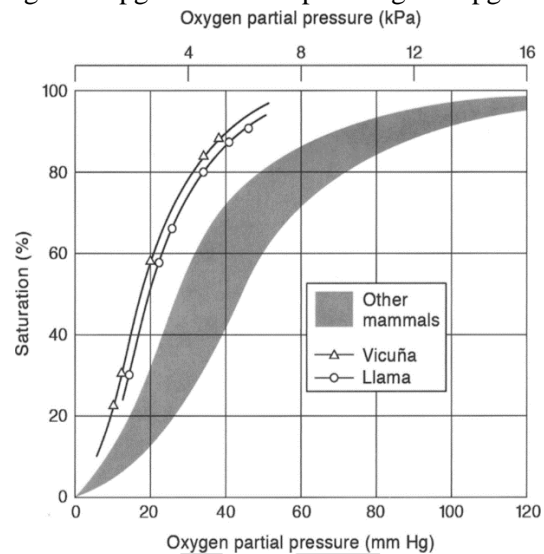

Mammals living at high altitudes

1. These possess an improved capillary network in the lungs which coupled with their deeper breathing (hyperventilation) insures increased oxygen uptake.
2. They have an increased red blood cell which increases the amount of oxygen transported by blood.
3. Increased haemoglobin concentration in the red blood cells which improves the amount of oxygen transported by the blood.
4. Changes in haemoglobin affinity for oxygen. Here the oxygen dissociation curve is shifted to the right to facilitate release of oxygen to the tissues. This particularly occurs at relatively lower altitudes.
5. Mammals living at altitudes about 3500m have their oxygen dissociation curves shifted to the left this favours their survival by promoting an increased affinity for oxygen by haemoglobin.
6. Increased myoglobin levels in muscles myoglobin has a higher affinity for oxygen than haemoglobin. This facilitates the exchange of oxygen from the blood to the tissues making oxygen available to the tissues.

Diving mammals e.g. seals, dolphins and whales.

1. They have a large spleen which can store large volumes of blood e.g. the seals spleen stores 24l of blood after the dive has begun, the spleen contracts and supplies the blood in circulation with additional erythrocytes that are highly leached with oxygen.
2. Have high concentration of myoglobin in their muscles. Myoglobin is an oxygen storing protein.
3. Mammals during the diving reflex slow down the pulse as the heart beat is also slowed down in order to effect an overall reduction on oxygen consumption since there is reduced cardiac output to the tissues.
4. Store oxygen in their blood as oxyhaemoglobin and this they achieve by having concentration of haemoglobin.
5. Blood supply to muscles is restricted and completely cut off during the longest dives hence encouraging anaerobic instead of aerobic respiration.
6. In this way, the muscles use sparingly oxygen stored in their myoglobin.

TRANSPORT OF CARBON DIOXIDE

Carbon dioxide is transported from the body tissues mainly in form of bi-carbonate ions in blood plasma to the lungs for removal.

Although carbon dioxide is mainly transported in form of bi-carbonate ions i.e. 85%, carbon dioxide can also be transported in the following ways;

- About 5% of carbon dioxide is transported in solution form. Most of the carbon dioxide carried in this way is transported in physical solution. A very small amount is carried as carbonic acid. In the absence of haemoglobin, the plasma proteins buffer the hydrogen ions to form weak proteionic acids.
- About 10% of carbon dioxide combines with the amino group of haemoglobin to form a neutral compound known as **carbamino haemoglobin (HbCO₂)**. If less oxygen is being carried by haemoglobin molecule, then more carbon dioxide is carried in this way as HbCO₂.

Transportation of carbon dioxide in form of hydrogen carbonate ion

When carbon dioxide is formed during respiration, it diffuses from the tissues into the erythrocytes, via their thin and permeable membrane. Inside the erythrocytes, carbon dioxide reacts with water in the presence of carbonic anhydrase enzyme to form carbonic acid as shown below;

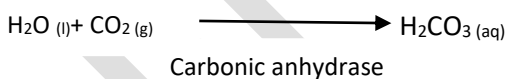
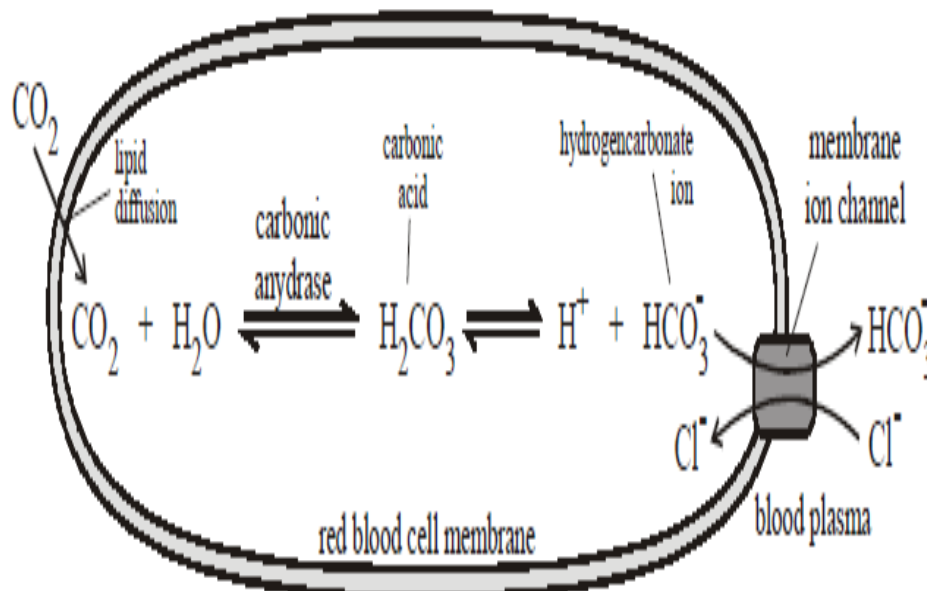

The formed carbonic acid then dissociates into hydrogen ions and bicarbonate ions as shown below



The formed hydrogen ions decrease the pH in erythrocytes which results into the dissociation of oxyhaemoglobin being carried from the lungs to the tissues into the free haemoglobin molecules as free oxygen molecules.

The free oxygen molecules diffuse into the tissues to be used in respiration. The free haemoglobin molecules buffer the hydrogen ions (H⁺) inside the red blood cells into a weak acid known as **haemoglobinic acid**

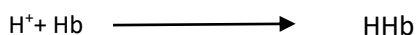

In case of excess H^+ plasma proteins are used to buffer them into another weak acid called **proteinic acid**.

The formed hydrogen carbonate ions within the erythrocytes diffuse out into the plasma along the concentration gradient and combine with sodium to form sodium hydrogen carbonate which is then taken to the lungs.

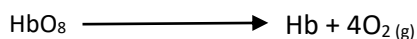

The outward movement of bicarbonate ions from the erythrocytes into the plasma results into an imbalance of positively charged and negatively charged ions within the cytoplasm. In order to maintain electrochemical neutrality, to remove this imbalance in the red blood cells, chloride ions diffuse from the plasma into the red blood cells, a phenomenon known as the **chloride shift**. When the bicarbonate ions reach the lungs, they react with H^+ to form carbonic acid which eventually dissociates into carbon dioxide and water.

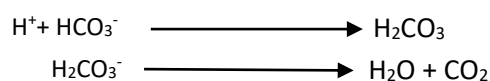

The carbon dioxide and water formed from the dissociation of carbonic acid in the lung capillaries are then expelled out by the lungs during exhalation so as to maintain the blood pH constant.

VASCULAR SYSTEMS IN ANIMALS

In animals, every vascular system has at least three distinct characteristics.

- It has a circulating fluid e.g. blood
- It has a pumping device in form of a modified blood vessel or a heart.
- It has tubes through which the fluid can circulate e.g. blood vessels

Note; animals require a transport system because of;

- Surface area of the organism
- Surface area: volume ratio of the organism
- Activity of the organism
- The diffusion distance for the transported substances between the tissues to and from their sources.
- There are two types of vascular systems, the open vascular system and the closed vascular system.

Open vascular system not on syllabus

Open circulation is the flow of blood through the body cavities called **Haemocoel** instead of flowing in blood vessels. This exists in most arthropods, molluscs and tunicates.

In this system, blood is pumped by an aorta which branches into a number of arteries which open into the haemocoel. From the haemocoel, blood under low pressure moves slowly to the tissues where there's exchange of materials e.g. gases, nutrients e.t.c. from the haemocoel blood percolates back into the heart via the open ended veins.

In insects the haemocoel is divided into two parts by a transverse pericardial membrane forming a pericardial cavity dorsally and the ventral perivisceral cavity.

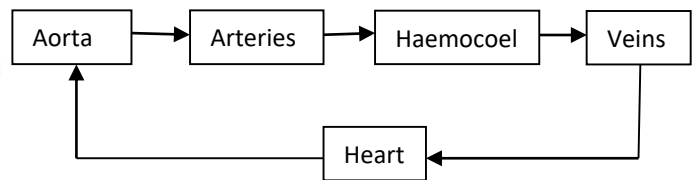
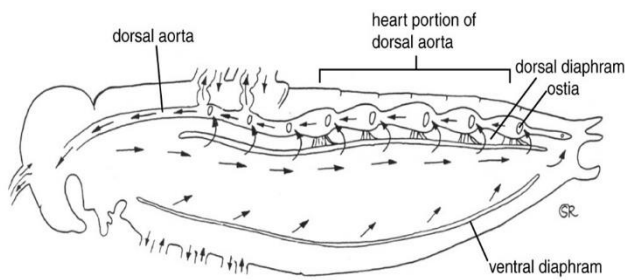

In the body of the insects there are no blood vessels except the tubular heart which is suspended in the pericardial cavity by slender ligaments and extends through the thorax and abdomen. The heart is expanded in each segment to form a total of 13 small chambers which are pierced by a pair of tiny tubes called **ostia**. The ostia allow blood to flow from one segment of the chamber to another. Alary muscles are located at each chamber of the heart.

Closed vascular system

In a closed vascular system, blood flows in blood vessels or sinuses. It occurs in all vertebrates, annelids such as earthworms, cephalopods and echinoderms. The distribution of blood in this system is therefore adjustable e.g. blood from the heart is at high pressure and that to the heart is at low pressure. Closed vascular systems are further divided into single and double circulation.

Single and double circulation

Single circulation is the flow of blood through the heart once for every complete circulation around the body. Single circulation occurs in fish and the deoxygenated blood from the body tissues is pumped by the heart to the gills from where it flows back to the body tissues and eventually returns to the heart.

Diagram showing single circulation in fish

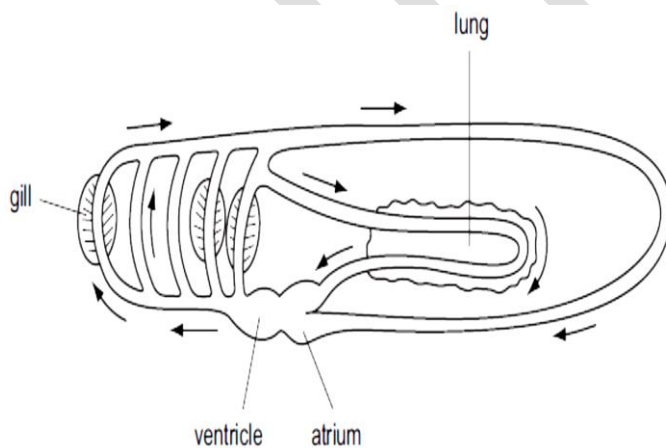

The problem of single circulation is that blood tends to move very slowly at the venous side due to the significant drop in pressure before completing the circulation. The drop in pressure is as a result of capillaries having a considerable resistance to blood flow i.e. capillaries in the gills and body tissues. The sluggishness of blood flow at the venous side is solved by replacing the veins with large sinuses

Vascular system of the earthworm (annelid)

The earthworm belongs to phylum annelida. Annelids are coelomate animals i.e. they have a body cavity that separates the muscular wall of the animal from the internal organs

The largest vessel is the longitudinal muscular-walled dorso vessel and it is above the alimentary canal (gut). The peristaltic contraction from the posterior end of the vessel drives blood forward to the anterior end of the animal. The backflow of blood is prevented by valves. Each valve originates from a fold of an internal membrane or tissue of any blood vessel that is called an endothelium. The dorso vessel collects and receives blood from the body wall, the gut, the nerve cord and the nephridia via capillaries.

Transverse section of the annelid vascular system

Clegg fig 17.6 pg 344

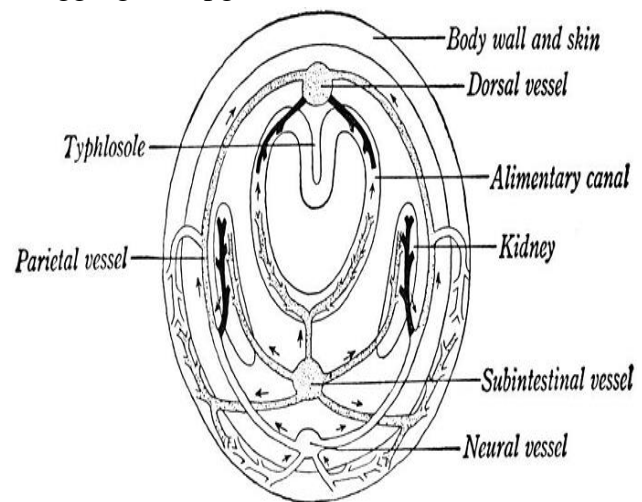

The dorso vessel connects with the smaller more contractile ventral vessel via five pairs of contractile pseudo hearts.

Each pseudo heart has four valves which permit the blood to flow towards only the ventral vessel and back to the posterior end of the animal.

Between the ventral vessel and the organs in the coelom e.g. nephridia and gut, there are a series of segmented blood vessels which run between them and they end up forming capillaries where there is exchange of materials between the organs and the blood in the capillaries. From the capillaries, blood fills its way back to the dorso vessel for its flow to the anterior side due to the peristaltic movement of the dorso vessel. The blood is red in colour with haemoglobin.

Double circulation

Double circulation is the flow of blood through the heart twice for every complete circulation around the body.

In double circulation deoxygenated blood from body tissues is pumped from the heart to the lungs from where it returns to the heart after being oxygenated and it is then re-pumped to the body tissues so as to supply oxygen to the body tissues. A double circulation serves as one of the solutions towards the sluggish flow of blood at the venous side in single circulation

In double circulation, the heart must be divided into the left and right chambers to prevent oxygenated blood from mixing with deoxygenated blood e.g. in reptiles, birds and mammals have a four chambered heart made up of the right atrium and ventricle and the left atrium and ventricle.

Diagram showing double circulation in a frog and a mammal

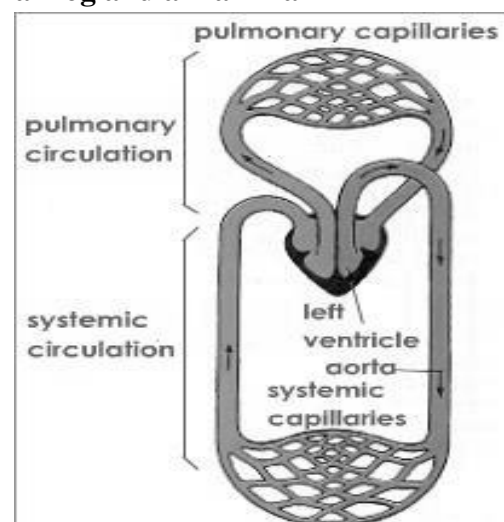

The frog experiences double circulation although its heart has three chambers namely; one ventricle and the two atria i.e. the left and right atria.

Both deoxygenated and oxygenated blood in the frog flow through the same ventricle and conus arteriosus at the same time without mixing. This is achieved due to the folding in the walls of the ventricle which enhances the separation of deoxygenated blood from oxygenated blood and this separation is also facilitated by the spiral valves in the conus arteriosus.

Some organisms e.g. the octopus and squids solve the problem of sluggish flow of blood of the venous side by possessing brachial hearts which pump deoxygenated blood from the body tissues of the gills and eventually back to the main heart. The main heart pumps, oxygenated blood to body tissues from the gills.

(Roberts fig 11.16 pg 175)

Fish
single circulation

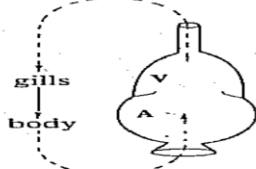

Fish
single circulation

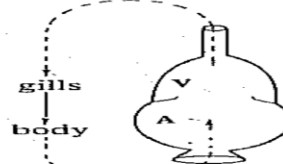

Amphibian
double circulation with partially divided heart

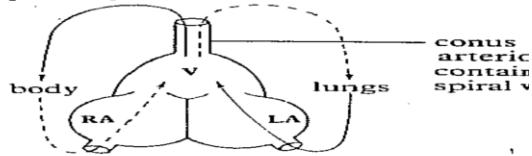

Amphibian
double circulation with partially divided heart

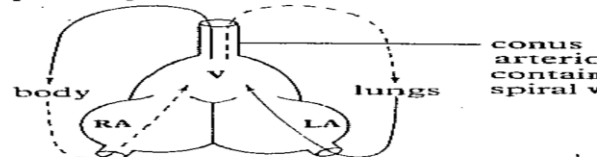

Mammal
double circulation with completely divided heart

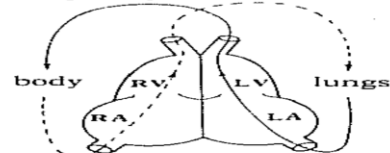

Mammal
double circulation with completely divided heart

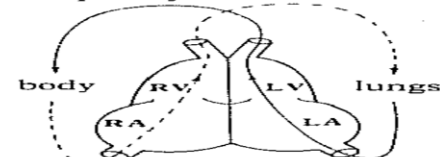

Octopus
separate hearts for body and gills

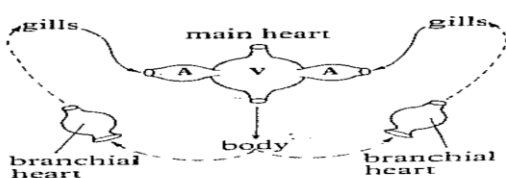

Octopus
separate hearts for body and gills

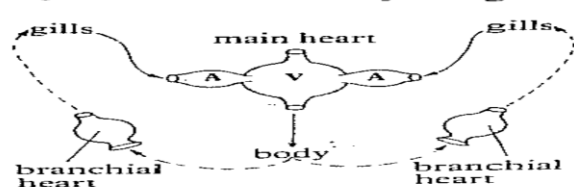

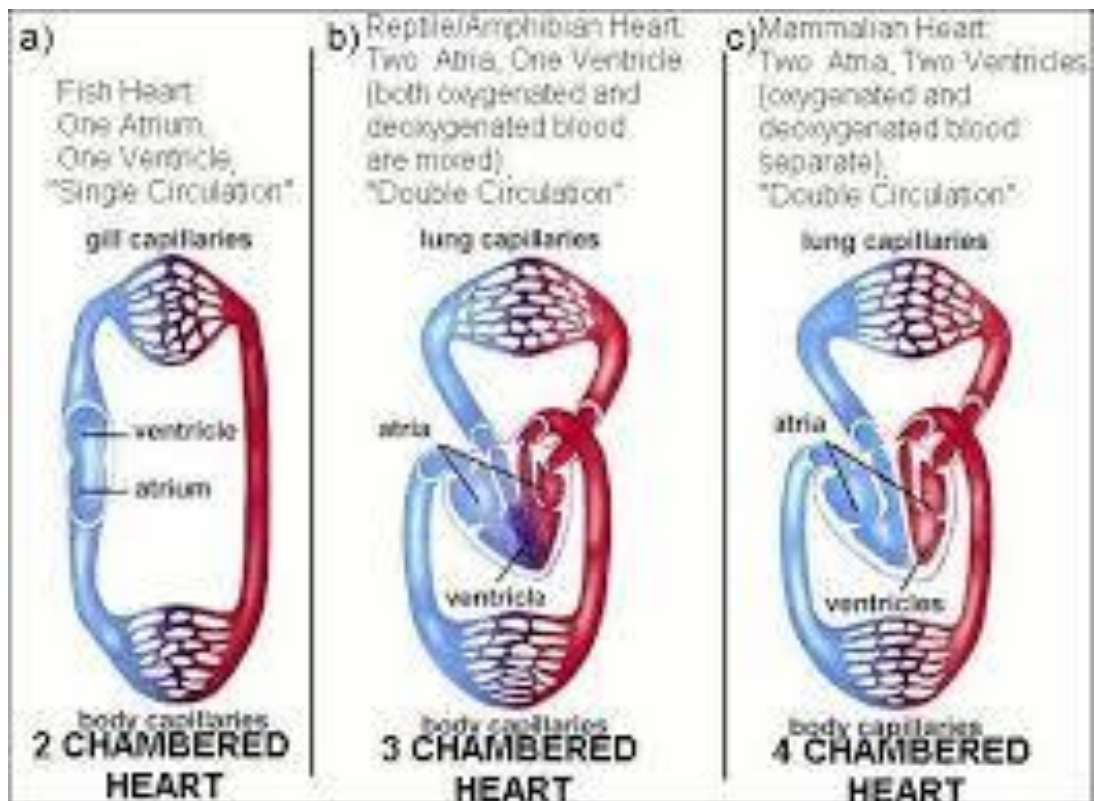

MAMMALIAN BLOOD CIRCULATION

The mammalian blood circulation is a double blood circulation which is mainly based on the heart and blood vessels,

THE MAMMALIAN HEART

Structure of the mammalian heart

The heart is the muscular organ pumping blood to all body organs using its chambers. It is made up of four chambers which include the right and left atria (auricles) and the right and left ventricles. The four chambers enhance the blood flow through the heart at the same time without mixing it i.e. the deoxygenated blood is separated from oxygenated blood. Oxygenated blood flows through the left atrium and ventricle while the deoxygenated blood flows through the right atrium and ventricle.

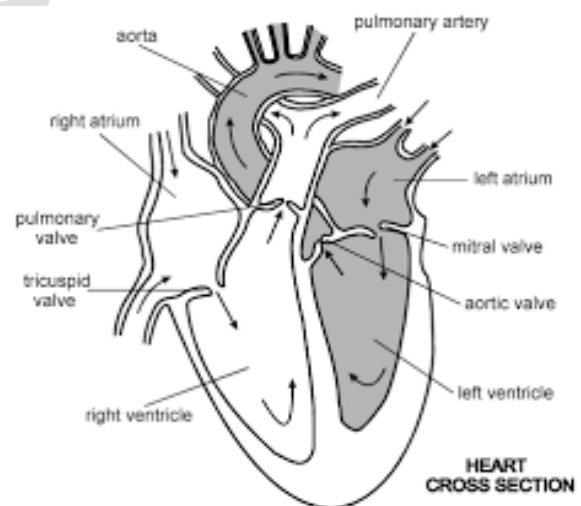

The heart is composed of the **cardiac muscles** within its walls which are **myogenic** in nature, in a way that, the initiation of their contraction is not under the control of the central nervous system but is within the muscles themselves.

This enables them to contract continuously and rhythmically without fatigue and therefore enables the heart to beat and pump without stopping. The heart consists of atrioventricular valves/ pocket valves and semi lunar valves. The atrioventricular valves include the following;

The three (3) flapped tricuspid valves found between the right atrium and the right ventricle

The two (2) flapped bicuspid valves which prevent back flow of blood from the left ventricle to the left auricle

The semi lunar valves are prevented from turning inside out by connective tissues called **tendinous cords**

The heart is linked with four blood vessels (1) **The venacava** which transports deoxygenated blood from body tissues through the right atrium of the heart. (2) **The pulmonary artery** which transports deoxygenated blood from the right ventricle of the heart to the lungs. (3) **The pulmonary vein** which transports oxygenated blood from the lungs into the left atrium of the heart. (4) **The aorta** which is the biggest vessel and it transports oxygenated blood from the left ventricle of the heart to the body tissues.

The left ventricle is more muscular (thicker) than the right ventricle because the left ventricle has to contract more powerfully than the right ventricle in order to enable oxygenated blood with high pressure to move for a long distance to the body tissues unlike the right ventricle which pumps deoxygenated blood with low pressure for a short distance to the lungs.

Initiation of the heart beat

The cardiac muscle within the walls of the heart is myogenic in nature in a way that the initiation of its contraction is within the muscle itself, but not under the control of the central nervous system (brain and spinal cord). This enables the muscles to contract continuously and rhythmically without fatigue to enable the heart to beat continuously and rhythmically without stopping. The intrinsic initiation of the heart beat enables the heart to remain beating even it is surgically removed from the body, provided it is under ideal conditions.

The rhythmic contraction of the cardiac muscles is initiated by specialized network of fine cardiac muscles network found inside the wall of the right atrium close to the entrance of blood from venacava into the right atrium. Clegg fig 17.8 pg 347

This network of fine cardiac muscle fibre is known as **Sino Atrial Node (SAN)** and it serves as a pace maker by giving off a wave of electrical excitations similar to impulses, which spread out very rapidly over both atria causing them to contract and force blood into the ventricles via the open atrial ventricular valves. When the electrical excitations reach the junction at the boundary of the atria, they excite another specialised plexus of other cardiac muscle chambers known as **Atrio Ventricular Node (AVN)**

When excited, the AVN sends waves of electrical excitations down to another bundle of cardiac muscle of fibres formed along the inter-ventricular septum called the Purkinje tissue or Bundle of His to the apex of the heart. This conducts and spreads the excitement to both ventricles which eventually pump blood into the arteries.

NOTE;

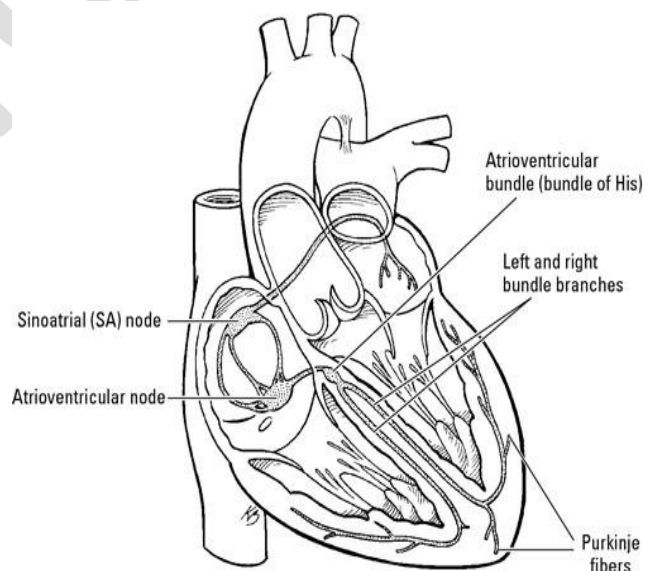

1. The closing of the atrioventricular valves during ventricular systole produces the first heart sound, described as **lub**.
2. The closing of the semi lunar valves causes the second heart sound, described as **dub**.
3. The pulse in the arteries is due to ventricular systole and elastic recoil of the arteries due to high pressure of blood.
4. The pulse is more pronounced in the arteries
5. The PCG (phonocardiogram) is a recording of the sound the heart makes. The cardiac muscle itself is silent and the sounds are made by the valves when closing. The first sound (lub) is the atrioventricular valves closing and the second sound (dub) it is the semi lunar valves closing.
6. The ECG (electrocardiogram) is a recording of the electrical activity of the heart. There are characteristic waves of electrical activity marking each phase of the cardiac cycle. It begins with a P wave, atrial depolarisation and the spread of the through the atria. The QRS complex indicates ventricular depolarisation. The T wave represents ventricular repolarisation. Changes in these ECG waves can be used to help diagnose problems with heart.

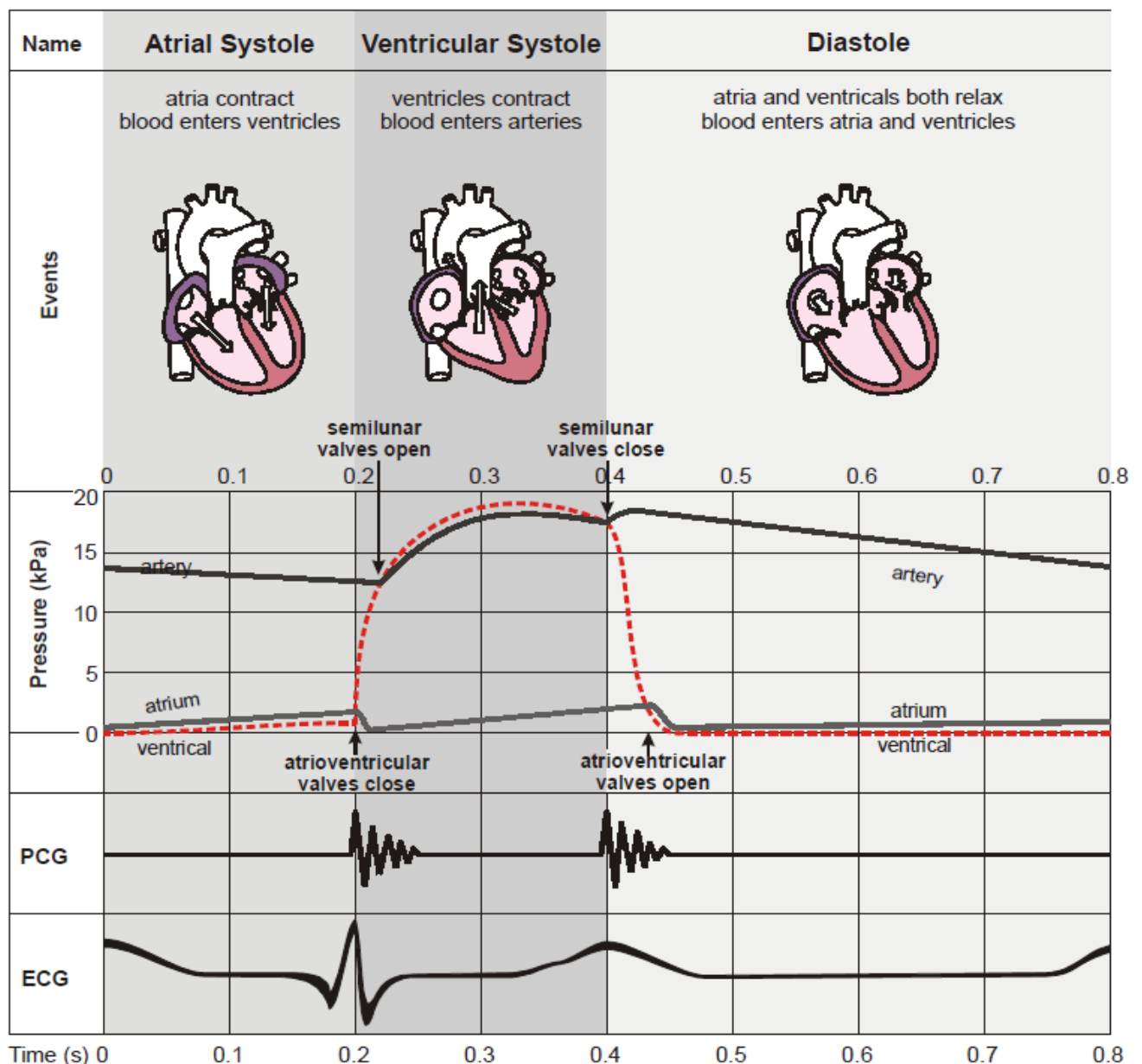

The cardiac cycle (Sequence of the heart beat)

This is the sequence of events of heart beat by which blood is pumped around the body. The pumping action of the heart consists of alternate contractions of heart muscles (cardiac muscles) called **systoles** and relaxations called **diastoles**. The term cardiac output refers to the volume of blood pumped from each ventricle.

The cardiac cycle begins with the contractions of the atria i.e. **atrial systole**, which is initiated by SANode and it which causes the atria volume to decrease and the atria pressure increases. As the atria contracts, the ventricles relax i.e. undergo ventricular diastole, causing the bicuspid and tricuspid valves to close. The contraction of the atria due to blood entering the atria forces the bicuspid and tricuspid valves to open so that blood moves from atria into the ventricles.

Contraction of atria walls has an effect of sealing off the venacava and pulmonary veins, thereby preventing the back flow of blood into the vessels as the blood pressure rises within the atria. It takes 0.1 seconds.

When the ventricles are filled with blood from atria, their walls contract simultaneously i.e. **ventricular systole**, and the atria relax i.e. **atrial diastole**. Ventricular systole is initiated by impulses from AVnode to the bundle of His, Purkinje fibres and rapidly through the ventricle muscles. The ventricles' volume reduces while the pressure increases, forcing the bicuspid and tricuspid valves to close and prevent the back flow of blood into the atria. The increased pressure in the ventricles also forces blood to be pumped into the pulmonary artery via the open semi lunar valves from the ventricles. This enables the blood to be pumped into the lungs via the pulmonary artery and into the body tissue via the aorta.

The ventricular systole is more powerful than the atrial systole because the ventricles are more muscular than the atria and therefore generate more pressure. The powerful ventricular systole forces blood into the atria and pulmonary artery.

After ventricular systole, there's a short period of simultaneous atrial and ventricular relaxations. In the **ventricular diastole**, the high pressure developed in the ventricles causes a slight back flow of blood which closes the semi lunar valves, thereby reducing blood back flow.

Relaxation of the atrial wall and contraction of the ventricle, initiates the refilling of the atria by blood under relatively low pressure i.e. deoxygenated blood in the venacava flows into the right atrium and oxygenated blood from the lungs flows into the left atrium via the pulmonary vein.

Intrinsic control of the heart beat

The cardiac muscle in the heart is myogenic. It contracts and relaxes automatically and does not depend on stimulation by nerves. The initial stimulus originates from the sino-atrial node (SAN), often called the pacemaker. The pacemaker is found in the right atrium wall at the entrance of the superior venacava. The membranes of the cells of the SANode are permeable to sodium ions. Sodium ions enter into these cells and the cell membranes are depolarized.

An excitatory wave of depolarization is generated which spreads rapidly from the SA node across the two atria causing them to contract simultaneously. A slowing down occurs as depolarization of the atrio-ventricular node (AVN) is delayed for about 0.1s to allow the atria to complete their contraction and empty the blood into the ventricles. Impulses from the AV node are conducted by specialized muscle fibres called bundle of His in the inter-ventricular septum towards the heart apex. Impulses are conducted by Purkinje fibres (Purkyne tissue) throughout the ventricular walls. This causes the contraction of both ventricles forcing blood into the pulmonary arteries and the aorta.

Characteristics of the cardiac muscle in relation to excitation and contraction

1. The absolute relative refractory period is longer than that of other muscles i.e. the heart cannot be fatigued easily
2. The generation of the wave from the SAN has a refractory period between contraction of the heart and relaxation of the heart i.e. the waves are not generated continuously.

Intrinsic control of the heart beat

The cardiac muscle in the heart is myogenic. It contracts and relaxes automatically and does not depend on stimulation by nerves. The initial stimulus originates from the sino-atrial node (SAN), often called the **pacemaker**. The pacemaker is found in the right atrium wall at the entrance of the superior venacava. The membranes of the cells of the SANode are permeable to sodium ions. Sodium ions enter into these cells and the cell membranes are **depolarized**.

An excitatory wave of depolarization is generated which spreads rapidly from the SA node across the two atria causing them to contract simultaneously. A slowing down occurs as depolarization of the atrio-ventricular node (AVN) is delayed for about 0.1s to allow the atria to complete their contraction and empty the blood into the ventricles. Impulses from the AV node are conducted by specialized muscle fibres called bundle of His in the inter-ventricular septum towards the heart apex. Impulses are conducted by **Purkinje fibres** (Purkyne tissue) throughout the ventricular walls. This causes the contraction of both ventricles forcing blood into the pulmonary arteries and the aorta.

Characteristics of the cardiac muscle in relation to excitation and contraction

1. The absolute relative refractory period is longer than that of other muscles i.e. the heart cannot be fatigued easily
2. The generation of the wave from the SAN has a refractory period between contraction of the heart and relaxation of the heart i.e. the waves are not generated continuously.

Hormonal control of the heart rate

A number of hormones affect the heart rate by stimulating the SANode, either directly or indirectly. Those with a direct effect are considered

- a) **Adrenaline hormone**. Adrenaline is secreted by the medulla (middle) of the adrenal glands. The adrenal medulla also secretes smaller amounts of hormone noradrenaline which has similar effects to adrenaline. Both stimulate the heart, although adrenaline is more effective. Cardiac output and blood pressure are increased heart rate. The two hormones also have other effects on the body which prepare the body for action (the 'flight or fight' response).
- b) **Thyroxine**. This is produced by the thyroid gland which raises the basal metabolic rate. This in turn leads to greater demand for oxygen production of more heat. As a result, vasodilation (dilation of the blood vessels) followed by increased blood flow occurs, and this leads in turn to increased cardiac output. Heart rate is also directly stimulated by thyroxine.

Control of the rate of the heart beat

Through the initiation of the contraction of cardiac muscle and hence initiation of heart beat are not under the control of the central nervous system, the rate at which the heart beats to pump blood is under the control of the autonomic (Involuntary) nervous system.

The heart is innervated by the sympathetic nerve from the sympathetic autonomic nervous system and by the vagus nerve, a branch of a parasympathetic autonomic nervous system. The nerves modify the rate at which the pace maker gives waves of electrical excitations hence controlling the speeding up or slowing down of the rate of the rate of heart beat.

When the rate of heart beat increases beyond the normal rate, the vagus nerve (parasympathetic nerve) is stimulated to release **acetylcholine** such that it lowers rate of the heart beat back to normal
 If however, the rate of the heart beat lowers below the normal rate or if there's need for higher rate of heart beat the sympathetic nerve releases **noradrenaline** to bring back or increase to the cardiac frequency usually to the normal rate. Therefore the sympathetic and vagus nerves are antagonistic, functionally.

(Clegg fig 17.13 pg 350 OR Soper fig 14.24 pg 475)

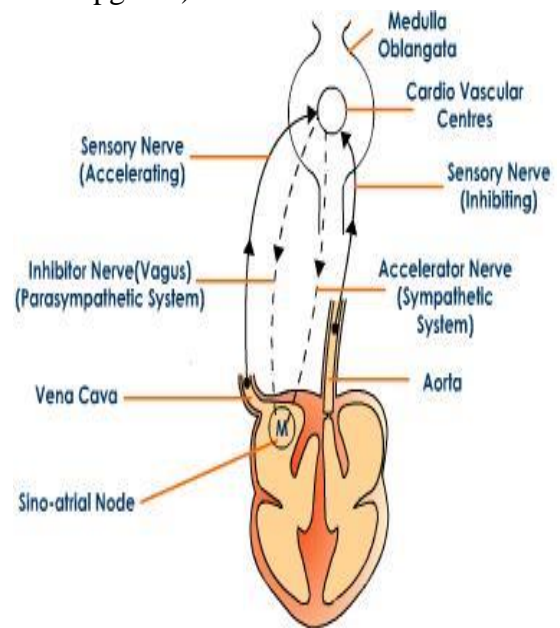

Cardiac output

It refers to the volume of blood pumped out from the heart, per minute by one ventricle.

Cardiac output (volume of blood going out of the heart) = **Rate of heart beat X Cardiac frequency**

- a) **Stroke volume** is the strength of the heart beat measured in volume of blood per heart beat
- b) **Heart rate** is the number of heart beats per minute

Cardiac output is regulated by the autonomic nervous system. The output increases when there is an increase in body activity. This serves to supply more oxygen and glucose to respiring cells and remove waste products. Prolonged athletic training strengthens the heart, increasing the heart muscles and enlarging the heart chamber. This leads to an increase in strength of cardiac muscle contraction and an increase in the stroke volume. Thus, at rest, the trained athlete has a higher cardiac output than an untrained person

Soper fig 14.25 pg 476

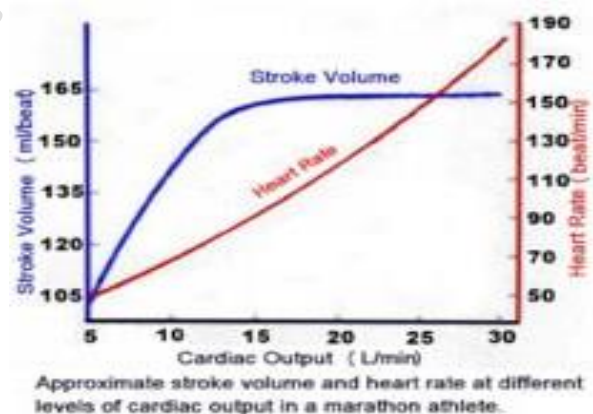

Explain the relationship between;

- Stroke volume and heart beats
- Cardiac output and heart beats

Short term effects of exercise on the cardiovascular system

- a) Cardiac output increases
- b) Vasodilation or vasoconstriction of different blood arterioles redistributes the blood towards muscles and away from organs such as kidneys and intestines, whose need is less immediate. The heart needs more blood to maintain the higher cardiac output and the brain must continue

to function normally in order to coordinate activities – its supply is therefore largely unchanged during exercise. As exercise generates heat, the blood supply to the skin is increased during exercise to help dissipate this heat to the environment.

- c) Increase in systolic blood pressure although diastolic pressure is largely unchanged.

Long term effects of exercise

- Hypertrophy of the heart i.e. increase in size of the heart (cardiac muscle)
- Increase in the stroke volume
- Decrease in the resting heart rate
- Increased maximum cardiac output
- Increased volume of blood
- Decrease in blood pressure when at rest
- Increased in the number of blood capillaries

Internal factors affecting the heart beat

- Body temperature
- Blood pH
- Carbon dioxide concentration
- Partial pressure of oxygen
- Hormonal balance
- Salt balance
- Blood pressure
- Emotional situations
- Impulses from the venacava and aorta

QN. Explain how change in each of the above factors may affect the heart beat

BLOOD VESSELS

There are three main types of blood vessels; arteries, veins and capillaries. The walls of these blood vessels occur in three layers, namely; (1) Tunica externa (outer most layer), (2) Tunica media (middle layer) & (3) Tunica interna (inner most layer)

Tunica externa, this is the outermost layer which is tough and made up of thick collagen fibres which provide strength and prevents extensive stretching.

Tunica media is the middle layer which consists of smooth muscles, collagen and elastic fibres. The structural proteins allow for the stretching of the walls of blood vessels during vasodilation. The smooth muscles allow for the distension and constriction of the walls of the blood vessels.

Tunica interna is the innermost layer composed of a single layer of squamous endothelium. It is found in all walls of blood vessels. Capillaries have only the tunica interna

Diagrams showing the transverse sections of the vein, artery and capillary

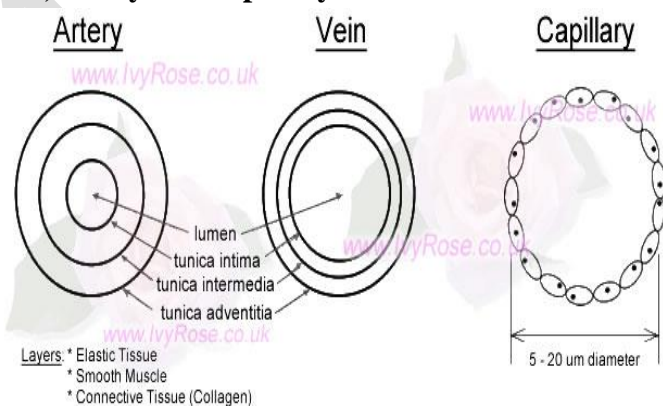

Arteries transport oxygenated blood from the heart to the tissues except the pulmonary artery which transports deoxygenated blood from the heart to the lungs while veins transport deoxygenated blood from tissues to the heart except the pulmonary vein which transports oxygenated blood from the lungs to the heart. Therefore **arteries** can be defined as blood vessels which transport blood away from the heart and **veins** are defined as blood vessels which transport blood from the tissues to the heart.

Comparison between arteries and veins

1. Both tunica media and tunica externa are more developed in arteries than veins and therefore arteries have thicker walls than those of veins. Arteries have thicker walls than veins because blood flows through them at a higher pressure than in the veins, due to the pumping action of blood by the heart. Arteries therefore have thicker walls to counteract the pressure by which blood moves through them. The capillaries lack both the tunica externa and the tunica media.
2. In addition the walls of the arteries are more elastic than those of veins, in order to overcome the pressure by which blood flows through them by rapidly stretching without bursting.
3. Also arteries have a narrower lumen than veins, which increases the pressure of the blood flowing through them.
4. Arteries also lack valves while veins have valves which prevent the backflow of blood in veins. However, arteries do not need valves since they transport blood under high pressure, which pressure ensures that blood flows forward

Adaptations of blood capillaries

1. They possess the capillary sphincter muscles which contract and relax so as to regulate the amount of blood entering into the capillary network.
2. Some capillaries have a bypass arterio-venous shunt vessel which links the arterioles and venules directly so as to regulate the amount of blood which flows through the capillary network e.g. in the capillaries of the feet, hands, stomach e.t.c.
3. They are numerous in number to provide a large surface area which increases the rate of diffusion and allows rapid exchange of materials between blood and the tissue fluid.

Diagram showing the capillary network

Clegg fig 17.18 pg 353

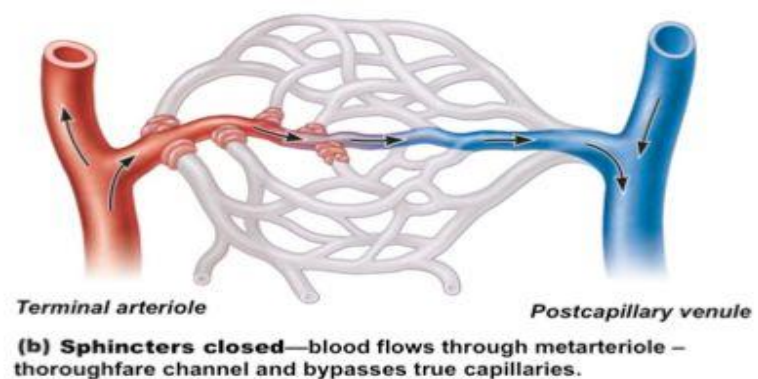
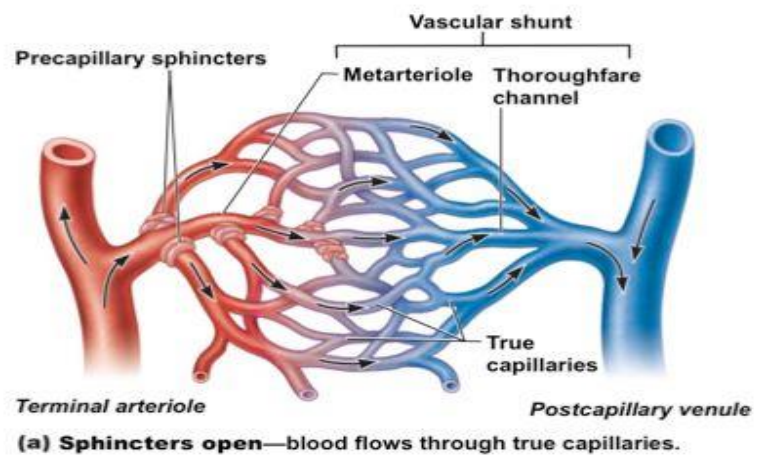

4. The capillary network offers maximum resistance to blood flowing through them hence decreasing the speed of blood flow which allows the maximum diffusion and exchange of materials between blood and the tissues. Blood capillaries are the smallest blood vessels found in close contact with tissues in form of a dense network which allows a high rate of diffusion of materials during their exchange between the blood circulatory system and the tissues.

5. They have a thin and permeable membrane which is made up of thin flattened pavement cells which allow rapid diffusion and exchange of materials between blood and tissues with minimum resistance.

Adaptations of veins to their function

1. The elastic layer is relatively thin because blood is under low pressure, cant cause them to burst and the pressure is too low to create a recoil action
2. The muscular wall is relatively thin because veins carry blood away from tissues and therefore their dilation and constriction cannot control the flow of blood to the tissues
3. The collagen fibres provide a tough outer layer in order to prevent the veins bursting from the external forces
4. There are semilunar valves throughout to ensure that blood does not flow backwards, which it might otherwise do because the pressure is so low.
5. The overall thickness of the wall is small because there's no need for a thick wall as the pressure within the veins is too low to create any risk of bursting.
- 6.

Blood flow velocity

The speed of blood flow reduces as it moves from arteries to arterioles to capillaries. Each artery conveys blood to so many capillaries that the total cross-sectional area is much greater in capillary beds than in the arteries or any part of the circulatory system. The result is an decrease in velocity from the arteries to capillaries than in the aorta.

The reduced velocity of blood flow in capillaries is critical to the function of the circulatory system. Capillaries are the only vessels with walls thin enough to permit the transfer of substances between the blood and interstitial fluid. The slower flow of blood through these tiny vessels allows time for exchange to occur. After passing through the capillaries, the blood speeds up as it enters the venules and veins, which have smaller total-sectional areas

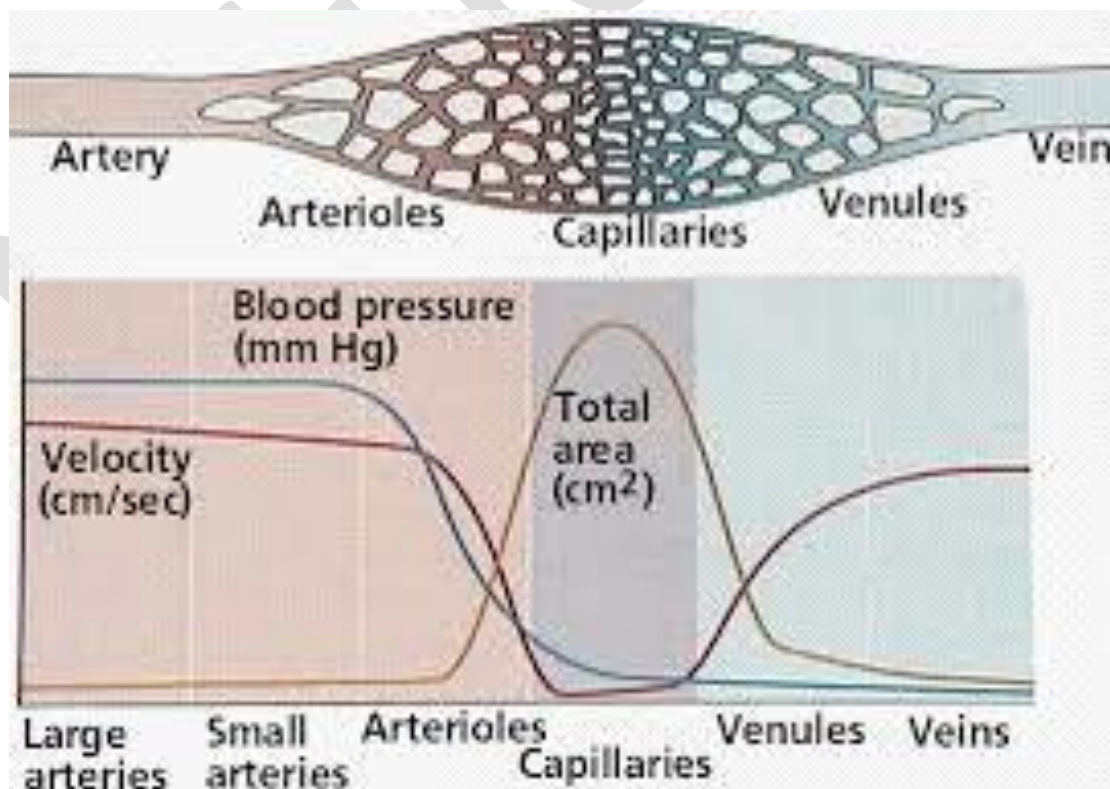

Blood pressure

Contraction of the heart ventricle generates blood pressure, which exerts a force in all directions. The force directed lengthwise in artery causes the blood to flow away from the heart, the site of highest pressure. The force exerted against the elastic wall of an artery stretches the wall, and the recoil of the arterial wall plays a critical role in maintaining blood pressure, and hence blood flow, throughout the cardiac cycle. The numerous arterioles and capillaries offer resistance to blood flow hence reducing the blood pressure.

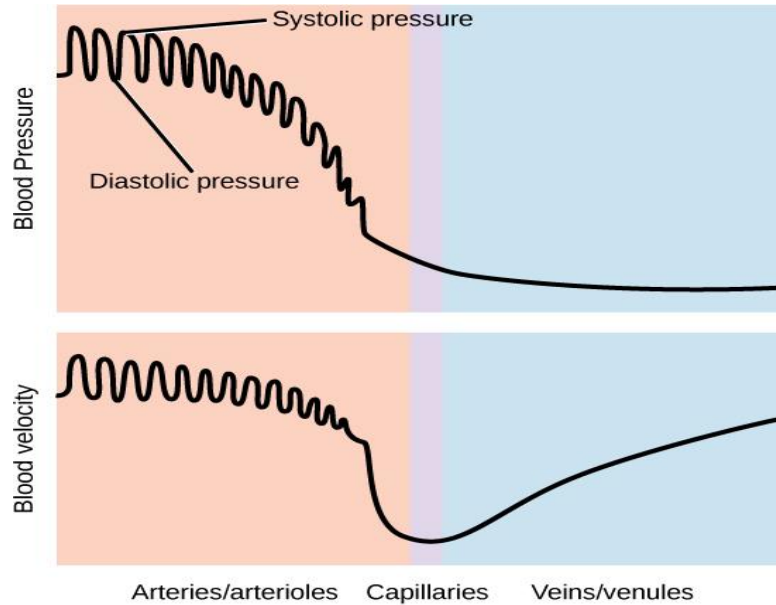

Changes in blood pressure during the cardiac cycle

Blood in arteries moves in form of **pulses** while in veins it flows smoothly without any pulse. A **pulse** is a series of waves of dilation that pass along the arteries caused by the pressure of the blood pumped from the heart through contractions of the left ventricle. Arterial blood pressure is highest when the heart contracts during ventricular systole, this is systolic pressure, which causes the expansion of the arterial wall. This is also due to the narrow openings of arterioles impeding the exit of blood from arteries. Hence, when the heart contracts, blood enters the arteries faster than it can leave, and the vessels stretch from the rise in pressure.

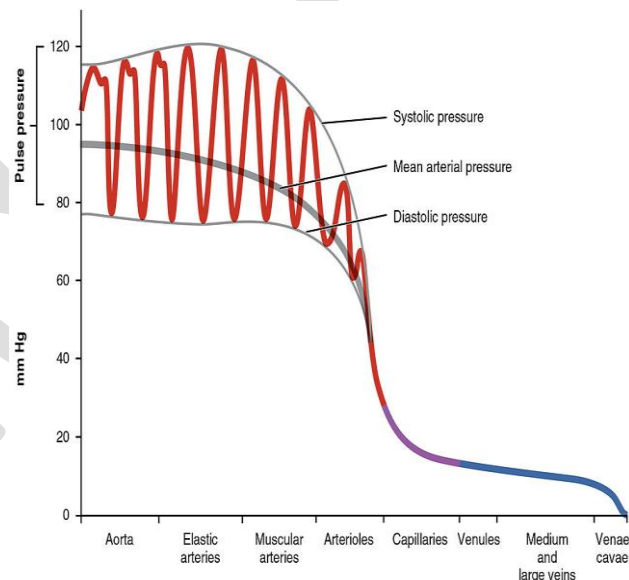

During diastole, the elastic walls of the arteries snap back. As a consequence, there's a lower but still substantial blood pressure when ventricles are relaxed (diastolic pressure). Before enough blood has flowed into the arteries to completely relieve pressure in the arteries, the heart contracts again. Because the arteries remain pressurized throughout the cardiac cycle blood continuously flows into arterioles and capillaries.

NOTE:

Blood is expelled from the heart only when it contracts. Blood flow through the arteries is therefore *intermittent*, the blood flowing rapidly during systole and slowly during diastole. However, by the time the blood reaches the capillaries it is flowing evenly. The gradual change from intermittent to even flow is made possible by the elasticity of the walls of the arteries which contain elastic tissue and smooth muscles

Control of blood pressure

Small receptors which are sensitive to stretching, called **baro receptors** are found in the walls of aortic arc, carotid sinuses, vena cava and the right atrium become stimulated when blood pressure increases above the norm. They fire impulses to the vasomotor centre and cardio vascular centre found in the medulla oblongata of the brain via the afferent nerves (sympathetic nerves). The cardio vascular centre sends impulses to the heart via the efferent nerves (vagus nerves), which results into reduction of the cardiac output. The vasomotor centre on receiving impulses, its sympathetic output is suppressed and this lowers the blood pressure by causing vasodilation of the arterioles

When the blood pressure lowers below the norm, the baro receptors stop being stimulated and this leads to impulses being fired from the cardio vascular centre to heart. The cardiac output is then increased. Decrease in blood pressure also increases the vasomotor centre sympathetic output which results into vasoconstriction of the arterioles hence increasing the blood pressure back to normal.

NOTE: When the arterioles constrict (vasoconstriction) blood pressure is raised and when they dilate (expand) the blood pressure decreases.

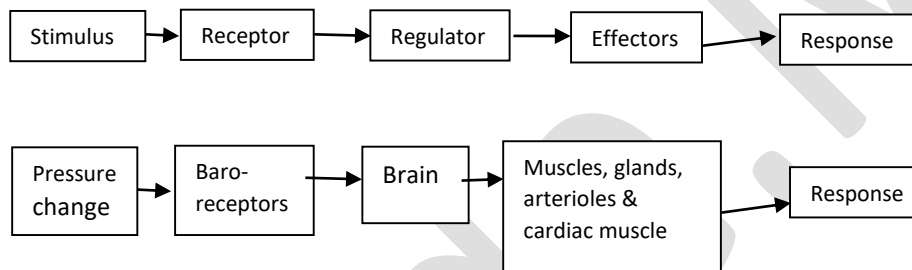

Note:- Blood pressure d

The brain includes the vasomotor, cardiovascular centre and the medulla oblongata

1. Blood volume
2. Force of the heart
3. Blood vessel radius/ diameter of the lumen
4. Blood volume is adjusted to some extent through contraction of the spleen and liver which bring stored blood into circulation. The stored blood is due to the regulation of the fluid intake and fluid loss by organs such as the kidney and the skin during homeostasis.

Blood vessels offer resistance

[Clegg fig 17.17 pg 352 OR Soper fig 14.26 pg 477]

(**R**) to blood flow. The resistance is inversely proportional to the fourth power of the radius (**r**) of the vessel ($R \propto \frac{1}{r^4}$). Therefore,

the resistance increases as the vessel becomes narrower and since we are dealing with the fourth power of the radius, small changes in the arterioles radius will make a large difference to the resistance.

Note:-Blood pressure depends on the following factors;

- Blood volume
- Force of the heart (cardiac output) i.e. blood from the ventricles
- Blood vessel radius/ diameter of the lumen i.e. resistance to blood flow

Blood volume is adjusted to some extent through contraction of the spleen and liver which bring stored blood into circulation. The stored blood is due to the regulation of the fluid intake and fluid loss by organs such as the kidney and the skin during homeostasis.

Blood vessels offer resistance (**R**) to blood flow. The resistance is inversely proportional to the fourth

power of the radius (**r**) of the vessel ($R \propto \frac{1}{r^4}$). Therefore, the resistance increases as the vessel becomes narrower and since we are dealing with the fourth power of the radius, small changes in the arterioles radius will make a large difference to the resistance.

Blood pressure is **increased** by;

1. Increased cardiac output e.g. during exercise
2. Increased resistance to blood flow e.g. vasoconstriction and atherosclerosis
3. Increased blood volume e.g. due to retention of water by the kidney under the influence of ADH

Blood pressure is **decreased** by;

1. decreased cardiac output e.g. during sleep or rest
2. decreased resistance to blood flow e.g. vasodilation
3. decreased blood volume e.g. during loss of blood due to injury

TOPIC 7: DEFENCE AGAINST DISEASES

Every mammal is equipped with a complex system of defensive mechanisms which are designed to enable it prevent the entry of microbes into it, to withstand attacks by pathogens (disease causing micro-organisms) and to remove foreign materials from the system.

The defensive mechanisms of blood include the following;

1. Clotting of blood
2. Phagocytosis
3. Immune response to infection

Clotting of blood

When a tissue is wounded, blood flows from it and eventually coagulates to form a blood clot which covers the entire wound. This prevents further blood loss and entry of pathogens. The process of blood clotting is described below.

When blood platelets and damaged tissues are exposed to air, the platelets disintegrate and release an enzyme called **thromboplastin** or **thrombokinase**, which in the presence of plasma proteins and calcium ions catalyses

Thrombin is a proteolytic enzyme that hydrolyses a plasma protein called **fibrinogen** into an insoluble protein called Fibrin forms fibres at the wounded area. Within the fibrous network of fibrin

blood cells become trapped, thereby forming a fibrin clot or a blood clot. The clot not only prevents further blood loss, but also prevents the entry of bacteria and other microbes which might otherwise cause infection

Note:

Heparin is an anticoagulant which inhibits the conversion of prothrombin to thrombin thereby preventing blood clotting.

Apart from blood clotting, the entry of microbes into the body can be prevented by the following;

1. Using impermeable skin and its protective fluid called sebum (oily secretion in the skin)
2. Using mucus and cilia to trap the microbes and then remove them
3. By using hydrochloric acid in the stomach
4. By using lysozyme enzyme in the tears and nasal fluids
5. By vomiting and sneezing

(Clegg fig 17.41 pg 365)

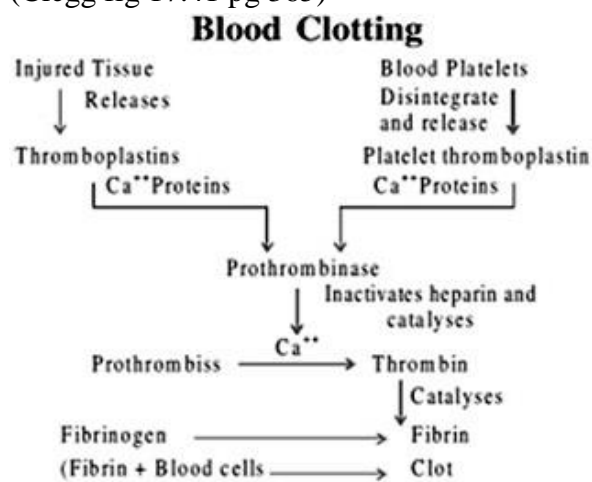

Why blood does not clot in the vessels

Connective tissue plus the liver produce chemical, heparin, which prevents the conversion of prothrombin to thrombin, and fibrinogen to fibrin.

Blood vessels are smooth to the flow of blood. Damage to the vessel's endothelium can lead to platelets breakdown which leads to clotting of blood.

BODY DEFENCE SYSTEM AND MECHANISM IN MAMMALS (HUMANS)

An animal must defend itself against unwelcome intruders e.g. dangerous viruses and other pathogens it encounters in the air, water and food. The body also deals with abnormal cells (cancer cells) that develop periodically in the animal's body.

A summary of defence mechanisms in an animal's body

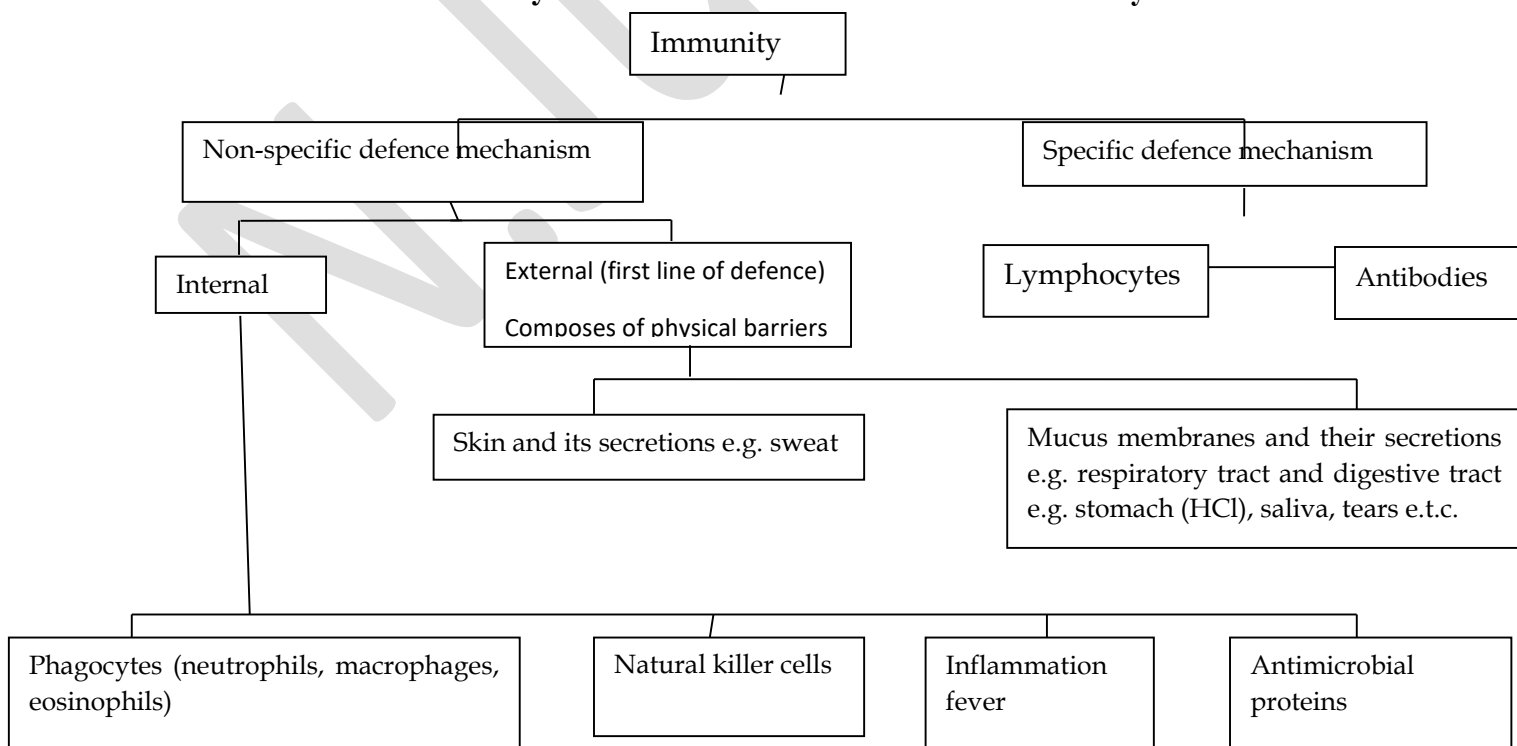

Two comparative defensive systems are used to fight pathogenic and abnormal cells in the body. One of the system is **non-specific** in nature i.e. it does not distinguish one infectious agent from another. The other defence system is **specific** in nature and constitutes the **immune system**. The non-specific system includes two lines of defence which an invader encounters in sequence. The first line of defence is external comprising of epithelial tissues that cover and line our bodies (skin and mucus membranes) and other secretions these tissues produce. The second line of non-specific defence is internal. It is triggered by chemical signals and uses antimicrobial proteins and phagocytic cells that indiscriminately attack any invader that penetrates the body's outer barrier (inflammation is a sign that the second line of defence has been deployed).

The immune system constitutes a third line of defence which comes into place simultaneously with the second line of specific defence. However, the immune system responds specifically to a particular type of invader. This immune response includes the production of specific defence proteins called **antibodies**. It also involves participation of several different types of cells that are derived from the white blood cells called **lymphocytes**.

NOTE: the non-specific defence system which involves use of phagocytes, natural killer cells and antimicrobial proteins is said to offer innate immunity (defence) which is abroad defence mechanism against infection. The immune response offers a specific defence against infection. It is also described as **acquired immunity**. Immunity is the ability of an organism to resist infection or to counter the harmful effects of toxins produced by infecting organisms.

NON SPECIFIC DEFENCE MECHANISM

The non-specific defence mechanism act in 6 ways i.e

1. Through physical barriers e.g. skin.
2. Phagocytosis.
3. Natural killer cell.
4. Anti-microbial proteins.
5. Inflammation.
6. Fever

THE SKIN AND MEMBRANES

This is the first line of defence and it takes a different number of forms.

The intact skin is a **(1) barrier** that cannot be penetrated by bacteria or viruses, although minute abrasions allow their passage [some pathogens such as the malarial parasite *Plasmodium*, use a vector, the mosquito, to penetrate this covering and so gain entry to the body]. In the same way, the **(2) (a) mucus membranes** which line the digestive, respiratory and urinal genital tracts prevent the entry of potentially harmful microbes [such areas cannot be covered by a thick layer of skin due to the body's need to obtain and lose substances by diffusion]. Mucus, which is a viscous secreted by cells of the mucus membranes also traps particles that contact it. Microbes entering the upper respiratory system are caught in the mucus and are then swallowed or expelled. The lining of the trachea has specialized epithelial cells equipped with cilia which sweep out microbes and other particles trapped by mucus, preventing them from entering the lungs.

Apart from their role as physical barriers, the skin and mucus membranes produce secretion that counter pathogens e.g. in humans, secretions from the **(b) oil and sweat gland** give the skin a pH ranging from 3-5 which is acidic enough to discourage micro-organism from colonizing there, bacteria that make the normal flora of the skin are adapted to its acidic relatively dry environment. **(c) Saliva, tears** and mucus secretions that bathe the surface of the exposed epithelia wash away

many potential invaders and in addition to these secretions contain various antimicrobial proteins. For example the enzyme cysozyme which digests the cell walls of many bacteria, destroys many microbes entering the upper respiratory system and openings around the eyes.

Microbes present in food or trapped in swallowed mucus, from the upper respiratory system pass, through the highly **(3) acidic gastric juice** produced by the stomach lining which denatures the enzymes of most of the microbes before entering the intestinal tract.

Despite these precautions, **pathogens** still frequently gain entry and therefore the body has a second line of defence, a series of specific cellular and chemical defences designed to;

- neutralise any toxins produced by the pathogens
- prevent the pathogen multiplying
- kill the pathogen
- remove any remains of the pathogen

Phagocytic defence mechanism

Phagocytosis is the process by which large particles are taken up by cells, in the form of vesicles formed from the cells surface membrane. **Two types of white blood cells (1) neutrophils and (2) monocytes** are attracted by chemicals released by body cells which have been damaged by invading pathogens. These white blood cells show **amoeboid movements** which engulf, ingest and destroy pathogens. They are known as **phagocytes** and are produced in the marrow of the long bones. Neutrophils can squeeze through blood capillary walls a process called **diapedesis** and move about in tissue spaces. The monocytes migrate out of blood stream then become larger white blood cells (leucocytes) called **macrophages**. Some macrophages are permanently located in tissues and organs such as the liver, spleen, kidney and lymph nodes while other circulate throughout the body. The term macrophage means “**big eater**” and these cells are long lived phagocytes which even engulf much larger particles like old red blood cells and protozoan parasites.

- **Antibodies** attach themselves to **antigens** on the surface of the bacterium
- Proteins, found in the plasma, attach themselves to the antibodies
- As a result of a series of reactions, the surface of the bacterium becomes coated with proteins called **opsonins**. This process is called **opsonisation**.
- Complement proteins and any chemical products of the bacterium act as attractants, causing neutrophils to move towards the bacterium.
- Neutrophils attach themselves to the opsonins on the surface of the bacterium
- Neutrophils engulf the bacterium to form a vesicle, known as a **phagosome**.
- **Lysosomes** move towards the vesicle and fuse with it

A drawing to summarize the phagocytic process affected by neutrophil, macrophage or monocytes.

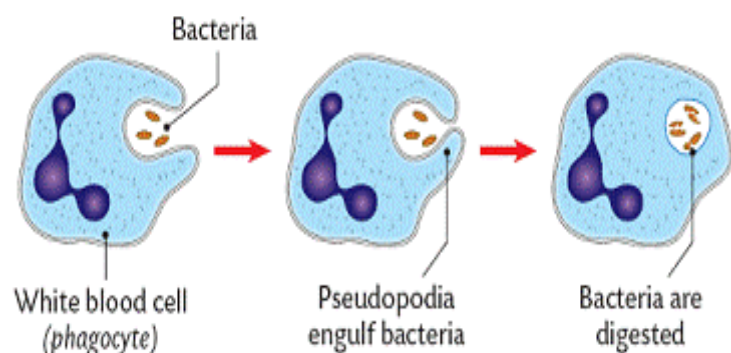

- The enzymes within the lysosomes breakdown the bacterium into smaller, soluble materials
- The soluble products from the breakdown of the bacterium are absorbed into the cytoplasm of the neutrophils.

Note: The **eosinophils** have low phagocytic activity but are critical to defence against multicellular parasitic invaders such as the blood fluke (*Schistosoma mansoni*) they rarely engulf such a large parasite but position themselves against the parasites body and then discharge destructive enzymes which damage the invader

Inflammation

An inflammation is a localized non-specific response initiated by the defence system of the body due to physical damage to the skin or mucus membranes by bacteria. This physical damage causes **(1)** release of chemical signals such as **histamine** and **prostaglandins**. **(2)** The chemical signals induce increased permeability of the blood capillaries to blood components and **(3)** the flow of blood to the affected area respectively [having increased blood flow causes the area to swell]. **(4)** They also attract phagocytic cells and lymphocytes which on arrival at the site of injury, the **phagocytes** consume pathogen (the area becomes warm and pale red in colour) and the cells debris and consequently the tissue heals

Note. it is the damaged cells and certain leucocytes that produce histamine and prostaglandins. The histamine cause vasodilatation i.e. the capillaries dilate and the walls become leaky. As more fluid collects around the wound, the site becomes red, swollen and warm. The localized swelling is called **oedema**. The prostaglandins are the ones that promote blood flow to the site of injury and increase the sensation of pain.

Natural killer (N.K) cells

This is a class of white blood cells which attack virus injected body cells and abnormal cells that could form tumours.

The virus infected cells have viral proteins displayed on their surfaces and these are recognized by the natural killer cells contains perforin – filled vesicle.

When an N.K encounters a virus infected cell, perforin molecules are released by exocytosis. Perforin molecules make large holes of pores in the turgid cells plasma membrane, causing leakage of the cytoplasmic contents. This results into cell death. The membrane of NK cell is not affected by these membranes dissolving molecules

FEVER

Fever refers to increase in body temperature. It is triggered if microbes infect larger areas of the body in response to infection, certain leucocytes releases pyrogens which are also anti-microbial protein of the complement system. The pyrogen stimulate the hypothalamus to rise the body temperature set point from its normal value about 39⁰C hence causing a fever. The fever has several beneficial effects; It increases the activity of phagocytes which then attack the invading microbes more efficiently. It increases the production of interferon in virus infected cells. Interferons are proteins which inhibit viral replication, activate natural killer and stimulate macrophages to destroy tumour cells and virus infected cell

ANTIMICROBIAL PROTEINS

These are proteins that function in the mechanisms by attacking microbes directly or by impeding the production e.g. lysozyme.

Other antimicrobial proteins include about 30 serum proteins that make up the complement system proteins through a sequence of steps, leading to lysis (bursting) of invading cells.

Some complement proteins initiate inflammation and also play a role in acquired defence (specific defence system) interferon is one of the proteins of the complement system which provides innate defence against viral infection the interferon protein is secreted by virus infected body cells and induce neighbouring uninfected to produce other substances that inhibit viral reproduction. In this way, interferons limit the cells spread of viruses in the body helping control of viral infections such as colds and influenza.

SPECIFIC DEFENCE SYSTEM /IMMUNE SYSTEM

The specific immune response confers immunity against specific microbes and it depends on a type of white blood cells called **lymphocytes**. Immunity is the capacity of an organism's body to recognize the intrusion of foreign materials in the body and mobilize cells and cell products (**antibodies**) to remove a particular sort of foreign material to a greater speed and effectiveness. The specific defence system involves immune system whose response results from the interaction among several types of lymphocytes, the molecules they produce (antibodies) and the foreign material introduced by microbes (**antigens**)

Molecules of the immune system

a) Antigen

An antigen is any organism or substance that is recognised as non-self (foreign) by the immune system and provokes an immune response. Antigens are usually proteins that make up the cell surface membranes of invading cells, such as microorganisms, or diseased ones, such as cancer cells. The presence of an antigen triggers the production of an antibody as part of the body's defence system.

b) Antibody

This is a specific protein (immunoglobulin) which recognizes and binds to specific antigens. Antibodies either neutralise antigens or tag cells that are antigens for easy attack by macrophages. They are synthesised by cells in the blood called **B-lymphocytes**. **Note:** Macrophages are also taken to be part of the immune response i.e. involved in specific defence mechanism through indirectly since they are phagocytes which destroy microbes and alert other immune cells the infection.

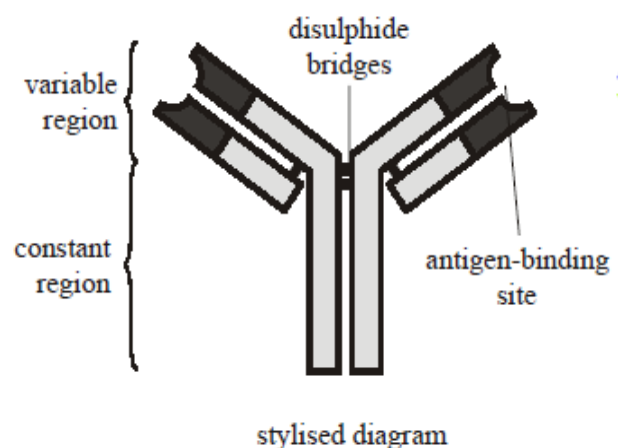

How antibodies work

An antibody does not directly destroy an antigenic invader. However specific antibodies bind to specific antigens, in the same way a key fits a lock, to form an antigen antibody complex

which is the basis for several effector mechanisms which make macrophages recognize the antigens and destroy them. The binding of antibodies to antigens is very specific and takes various forms, some of which include the following:

- **Neutralisation**

Here the antibody blocks certain sites on an antigen or **toxins** (chemicals that cause many of the symptoms of a disease) making it ineffective. Antibodies neutralise a virus by attaching to the sites the virus uses to bind to its host cell. Also bacterial toxins become coated with antibodies hence getting neutralised, eventually, phagocytic cells (macrophages) destroy these antigen-antibody complexes.

- **Agglutination (clumping)**

This is when antibodies cross link adjacent antigens. This is made possible because certain antibodies possess at least two antigen binding sites. The clumping of antigens e.g. bacteria makes it possible to be recognized by macrophages and other phagocytes which destroy the antibody-antigen complex

- **Precipitation**

This is a similar mechanism to agglutinations, except that here the antibody-antigen complexes are formed with soluble antigen molecules rather than cells are linked to form immobile precipitates which are captured by phagocytes and macrophages that destroy them i.e. soluble antigens are precipitated out so that they are easily destroyed by phagocytes.

- **Opsonisation**

Here, the antibody molecule coats the surface of a microbe making it easier for **phagocyte** and **leucocytes** to engulf it.

- **Lysis**

Having attached themselves to antigens on foreign cells, antibodies then attract other compound which bind to them. These include enzymes which help to break down the foreign cells.

- **Complement fixation**

Here, the antibodies activate the complement proteins which then leads to lysis of foreign cells.

c) **Epitopes**

These are antigens determinants with specific sequences of amino acids that confer as specific shape to the antigen molecules which is then recognized by an antibody or T-cell receptor. An antigen can have several different epitopes on its surface and different antibodies can therefore bind a single antigen.

d) **Cytokines (lymphokines)**

These are peptides and proteins that regulate many cell activities (growth and repair) and act as signal in both the specific and non-specific immune responses

Examples of cytokines include

- Interferons
- Interleukin

e) **Complement system.**

This is a group of about 20 proteins found in plasma and other body fluid. These are inactive until the body is exposed to antigens e.g. histamines.

Mechanism of immune responses

The immune response depends on a type of white blood cell called a **lymphocyte** formed in stem cells found in the bone marrow. There are two types of lymphocytes each with its own immune response to antigens, namely:

- a) **B lymphocytes (B cells) - humoral response** which involves antibodies which are present in body fluids or 'humour'. B-cells mature in the **Bone marrow**.
- b) **T lymphocytes (T cells) - cell-mediated response**. Which involves cells. T cells mature in the **Thymus gland**

Humoral response

The humoral immunity results in the production of antibodies which are secreted by B-cells, the antibodies circulate as soluble proteins in blood plasma and lymph, the fluids that were once called **humors**.

There are many different types of B- lymphocytes (close to 10 million) each producing a specific/different antibody which respond to one antigen.

When an antigen, e.g. a protein on the surface of a pathogen cells, enters the blood, or tissue fluids, it encounters numerous B cells. A few of these will carry the appropriate immunoglobulin on their surface membrane and will attach to antigens on the surface of the pathogen or toxin. This attachment has a dramatic effect on the B-cell. If given the right signal from the T-helper cells, the B-cell divides rapidly by mitosis to produce a large number of daughter cells i.e. **a clone**. This is referred to as **polyclonal activation**. Some of these daughter cells develop into **plasma cells** which produce and secrete up to 2000 molecules of their specific antibody per second. These antibodies destroy the pathogen, and any toxins it produces. The plasma cells are therefore responsible for the immediate defence of the body against infection. This is known as the **primary immune response**. Finally some daughter cells develop into **memory cells** which remain in the circulation without secreting antibodies. They can live for decades circulating in the blood and tissue fluid until they encounter the same antigen at some future date.

Memory and secondary immune response

Memory cells function in secondary immune response. In primary immune response there is **selective proliferation** (multiplication) of lymphocytes to form clones of effector cell upon the first exposure to an antigen. Here there is a lag period between initial exposure to an antigen and maximum production of effector cells. During the lag period, the lymphocytes secreted by the antigen differentiates into effector T-cells (TH and TC) and antibody producing plasma cells. If the body is exposed to the same antigen at a later time, the response is faster one/more prolonged than the primary immune response. This is the secondary immune response.

Secondary immune response is the rapid response that results in faster production of effector T cells and antibody-producing plasma cells, when the body is exposed to subsequent infection of the same antigen that has ever invaded the body. Antibodies produced during the secondary immune response are more effective in binding to the antigen than those produced during the primary immune response. The immune systems' ability to recognize an antigen as previously encountered is called **immunological memory**. The ability is based on long lived effector cells of the immune response, **memory cells**. These cells are not active, survive for long periods and proliferate rapidly when expose to the same antigen that caused their formation. Secondary immune gives rise to a new clone of memory cells as well as effector cells.

Graph to illustrate changes in antibody concentration during primary and secondary immune responses to antigens

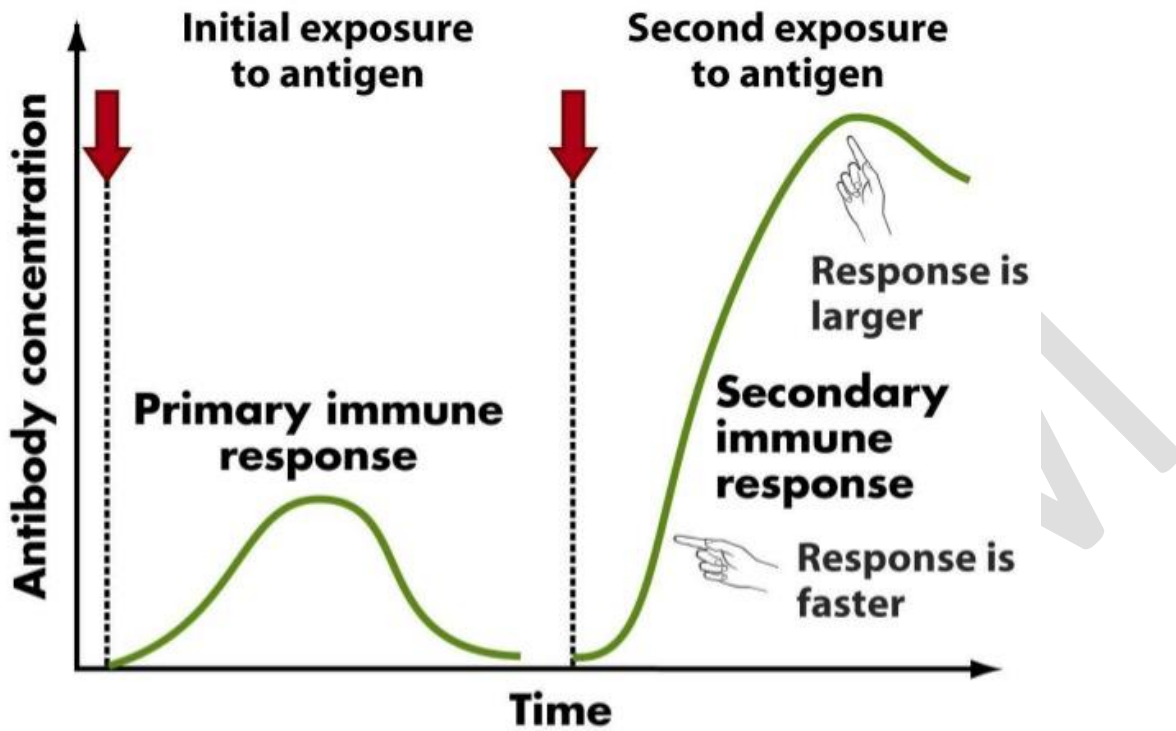

Primary immune response to antigen A produces antibodies to A.

Secondary immune response to antigen A produces antibodies to A; primary immune response to antigen B produces antibodies to B.

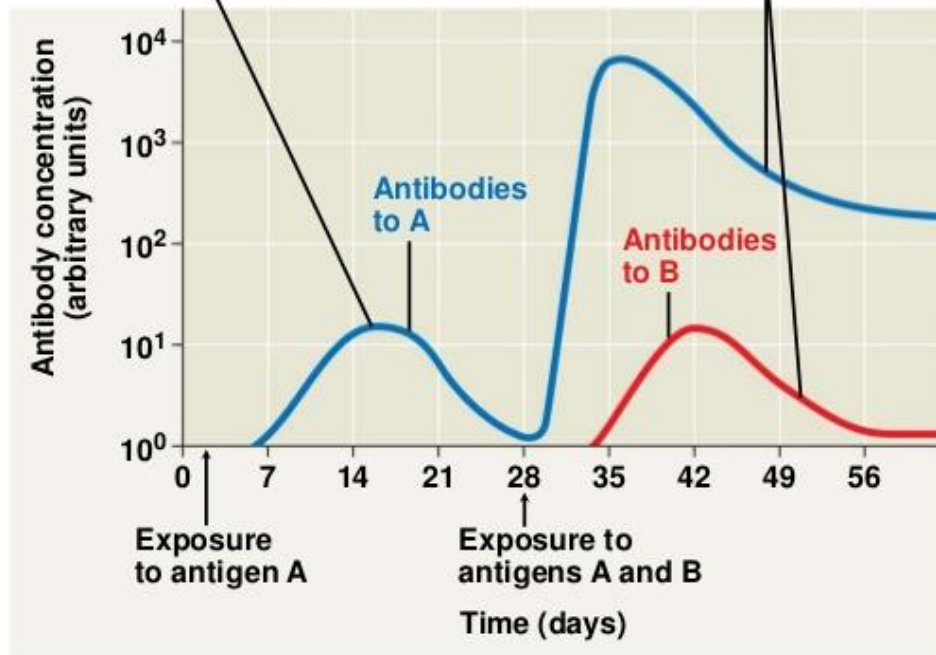

Cell mediated immune response.

In the cell mediated response, the immunity depends on the direct action of the T-lymphocytes rather than antibodies. T-lymphocytes only respond to antigens that are attached to a body cell (rather than those within body fluids). T lymphocytes respond to an organism's own cells that been invaded by non-self material e.g. virus or cancer cell. They also respond to transplanted materials, which is genetically different. Invader cells are distinguished from the normal cells because:

- a) macrophage cells that have engulfed a pathogen and broken it down, present some of the proteins produced on their own surface
- b) body cells invaded by a virus also manage to present some of the viral proteins on their own cell surface membrane, as a sign of distress
- c) cancer cells likewise display non-self proteins on their cell surface membrane.

The non-self materials on the surface of these cells act as **antigens** therefore the term **antigen-presenting cells** is used to describe them. There are many different versions of the two main types of T lymphocytes each with a different receptor protein on its surface. Although these receptors function in a similar way, they are **not antibodies**, because they remain attached to cell rather than being released into the blood plasma.

Note: The circulating antibodies of the humoral branch of the immune response defends the body against toxins, free bacteria and viruses present in the body fluids. In contrast, lymphocytes of the cell mediated branch are active against bacteria and viruses inside the body's cells and against fungi, protozoa and worms. The cell mediated immunity is also involved in attacks on transplanted tissue and cancer cells both of which are perceived as non self.

Major cells in the immune system.

1. B-cells (B-lymphocytes)

These are lymphocytes that produce antibodies when stimulated. They are produced and mature in the bone marrows from the **stem cells**. They have glycoprotein receptors on their cell surface membranes which bind specific antigens. Mature B-cells become plasma cells and memory cells produce much more antibodies in terms of quantity and effectiveness than plasma cells.

2. T-cells (T-lymphocytes)

The T-lymphocytes regulate the immune response (in case of T_H -cells) or kill certain types of cells (T_c -cells) the T cells are produced in the bone marrow but mature in the thymus gland where they develop specific receptors which recognise specific antigens. These are two main categories of T cell namely:

- a) **T cytotoxic cells (T killer cells)**, recognize and destroy cells with foreign antigens on their surface. They mainly attack virus infected cells, cancerous body cells and foreign grafted tissues. They kill not by phagocytosis but by making holes in the cell surface membrane using proteins called **perforins**. These holes allow water to rush into the cell, causing it to burst. Since viruses need living cells within which to reproduce, this sacrifice of body cells prevents viruses multiplying.
- b) **T-helper cells**, play a key in the immune system. When they attach to an antigen-presenting cell, T helper cells secrete chemicals called **cytokines**. These cytokines:
 - stimulate macrophage cells to engulf pathogens by phagocytosis

- stimulate B lymphocytes to divided and develop into antibody producing plasma cells
- activate T cytotoxic cells (T killer cells)

Both T helper and T cytotoxic cells produce their own type of memory cells, which circulate in the blood in readiness to respond to future invasions by the same pathogen.

Another type of T lymphocyte is the **T suppressor cells**, suppress the activity of the killer T-cells and B-cells after the microbes have been cleared out of the body to prevent these cells from attacking and destroying the body cells. Suppressor T-cells therefore regulate the immune response and prevents antibodies from being produced by the B-cells.

3. Memory cells

These are derived from B cells and T-cells. They are long lived and confer future immunity against subsequent infections by the same antigen i.e. they are the ones responsible for causing the secondary immune response.

Characteristics of the immune system

The immune system develops specific response against each type of foreign microbes, toxin or transplanted tissues.

The immune system has 4 features i.e.

- a. Specificity.
- b. Diversity
- c. Memory
- d. Self/non self-recognition.

a. Specificity

The immune system has the ability to recognize and eliminate particular microorganism, and foreign molecules. The immune system responds to an antigen by activating specialized lymphocytes and producing specific proteins called antibodies.

Antigens that trigger an immune response include molecules belonging to viruses, bacteria, fungi, protozoa and parasitic worms.

Anti-bodies recognize antigens using epitopes which are antigenic determinants on the surfaces of the antigens. If an antigen has several epitopes, it stimulates several different B cells which secrete specific distinct antibodies against it. Therefore each antigen has a unique molecular shape and stimulate the production of the very type of antibody that defends against that specific defences, each response the immune system targets a specific invader distinguishing it from other foreign molecules that may be very similar.

b. Diversity

The immune system has the ability to respond to very many kinds of invaders each recognized by its antigenic markers. This diversity of response is possible because the immune system is equipped with an enormous variety of lymphocyte population among the antibody producing lymphocytes (B-lymphocytes) each population is stimulated by a specific antigen and response synthesizing and secreting the appropriate type of antibody.

c. Memory

The immune system has the ability to “remember” antigen encountered and react more promptly and effectively on the subsequent exposures. This characteristics also known as acquired immunity.

d. Self/non self-recognition

The immune system distinguishes the body's own molecules from foreign molecules (antigens). Failure of self/non self-recognition leads to anti immune disorders in which the immune system destroys the body's own tissues

Types of immunity

The ability of an organism to resist infection may be naturally acquired or artificially induced.

Natural immunity is immunity which is either inherited, or acquired as part of normal life processes, e.g. as a result of having had a disease. **Artificial immunity** is the immunity acquired as a result of deliberate exposure of the body to **antibodies** or **antigens** in non-natural circumstances e.g. vaccines. Both natural and artificial immunity may be passively or actively acquired.

Types of natural immunity

a. Natural passive immunity

This involves passing antibodies in the body of an organism into the body of another organism of the same species e.g. from the mother to the foetus via to the placenta to defend the body against disease and also via the first milk called **colostrum** to the child. This type of immunity is temporary.

b. Natural active immunity

This is the immunity that involves formation of antibodies by the body of an organism in the presence of certain antigens.

This type of immunity is permanent because during the immune response, memory B-cells are produced which recognize the microbes on reinfection (second infection) and then stimulate the rapid production of large amounts of antibodies to curb down the microbes before causing significant damage. Memory B-cells stay for long in blood. It is for this reason that many people suffer diseases such as measles only once in a life time.

Artificial immunity

There are two types of acquired immunity namely:

- a. **Artificial active immunity** depends on the response of a person's own immune system. Here the individual organism produces antibodies using the B-lymphocytes against the infectious agent. Active immunity is naturally acquired but it can also be artificially acquired by vaccination.
- b. **Artificial passive immunity**. Occurs when antibodies from another individual are injected as in the treatment of tetanus.

NB. Passive immunity can also be transferred artificially by introducing antibodies from an animal or human who is already immune to the disease e.g. rabies is treated in humans by injecting antibodies from people who have been vaccinated against rabies. This produces an immediate immunity which is important because rabies progress rapidly and the response to vaccination would take too long.

EXPLANATION OF HOW THE KEY FEATURES OF AN IMMUNE SYSTEM ARE REALIZED DURING THE SPECIFIC DEFENCE MECHANISM.

SPECIFICITY AND DIVERSITY

Immunological specificity and diversity is based on clonal selection of lymphocytes if the antigen enters the body and binds to receptors on the specific lymphocytes, the nasal those lymphocytes are

activated to mount an immune response. The selected cells proliferate by cell division and develop into a large number of identical effector cells known as a clone. This clone of cells combat the very antigen that provoked the response e.g. plasma cells that develop from that function as the antigen receptor on the original B-cell. Which first encountered the antigen. The antigen specific selection and cloning of lymphocytes is called clonal selection.

In clonal selection, each antigen by binding to specific receptors selectively activate a tiny fraction of cells from the body's diverse pool of lymphocytes. These relatively small numbers of selected cells, all dedicated to eliminating the specific antigen that stimulated the humoral or cell mediated immune response.

N.B. Antigens are molecules (usually proteins, polysaccharides or glycoproteins carried on the surface of cells which cause antibody formation. All cells have antigen makers on their cell surface membranes but the body can distinguish between its own antigen (self) and foreign antigen (non self)

Self and non-self-recognition

Here, molecular markers on cell surface, function in self and non-self-recognition. The antigen receptors on the surface of lymphocytes are responsible for detecting molecules that enter the body. Normally, there are no lymphocytes that are reactive against the body's own molecules. Self-tolerance begins to develop as T and B lymphocytes bearing antigen receptors mature in the thymus and bone marrow and continues to develop with receptors for molecules present in the body are destroyed or rendered passive (non-functional) leaving only lymphocytes that are reactive against foreign molecules tolerated by an individual's immune system, are a collection of molecules encoded by a family of genes called the Major Histocompatibility complex (MHC) two main classes of MHC molecules mark cells as self. Class 2 MHC molecules are restricted to a few specialised cell types of the body's defence system e.g. macrophages, B-cells and activated T-cells.

NB. Class 2 MHC molecules play an important role in interaction between cells of the immune system.

ABNORMAL IMMUNE FUNCTION

Sometimes, the immune system fails to defend the animal against intruders instead turns against the components of the body which leads to certain disease. Conditions immune system abnormalities include;

1. Auto immune disease.
2. Allergy.
3. Immune deficiency.

Acquired Immunodeficiency Syndrome (AIDS). AIDS is a disease caused by a virus called the **Human Immunodeficiency Virus (HIV)**. HIV infects certain T cells, including helper T-cells, which carry a receptor called CD4 on their surface. Other cells with CD4 receptors include macrophages and some B lymphocytes. Glycoproteins on the HIV envelope bind specifically to this receptor. Following attachment, the virus enters the cells and disintegrates, releasing RNA and an enzyme called **reverse transcriptase**. The enzyme causes the cell to translate the viral RNA into DNA. The viral DNA enters the nucleus and is incorporated into the cell's own DNA. Thus a gene representing the HIV becomes a permanent part of the infected person's CD4 lymphocyte cells. Newly formed viruses bud from the host cell, circulate, and infect other cells. The infected cells may

produce new viruses by exocytosis for an extended time or may be killed quickly, either by the virus or by the response of the immune system. HIV may also remain latent for many years as a **provirus** assimilated into the genome of an infected cell. When the infected cell divides, it also makes a copy of the viral DNA. The provirus is invisible to the immune system because it does not produce viral proteins and infects the cells of the immune system itself, so impairing its ability to respond i.e. cannot be destroyed by circulating antibodies.

The ability of HIV to remain latent is one of the reasons why anti-HIV antibodies fail to eradicate the disease. Probably more important, however, are the extremely rapid mutational changes in antigens the virus undergoes during the infection. Indeed, every HIV probably differs in at least one small way from its parent. The immune system responds effectively against HIV infection at first, but it is eventually overwhelmed by the accumulation of more resistant variants. In the **figure below** notice that the number of viruses gradually increase as the helper T-cell population (and hence the body's protection,) decreases. When the damage to the immune system reaches a certain point, cell-mediated immunity collapses and secondary infections (opportunistic infections) e.g. Kaposi's sarcoma and pneumonia are established in the patient. [Remember that the major destructive cells of the immune system, T-cytotoxic and B cells, depend on stimulation by the T helper cells for their activity, inactivation of T helper cells knocks out the whole immune system]. Such infections are established in the late stages of HIV infection and are defined by a specified reduction of T- cells. These infections are called AIDS. The time from infection to AIDS varies, but it averages about 10 years. Death usually results from the opportunistic infections

The progress of the disease from HIV infection to AIDS can be categorised into four phases.

(a) First phase

Most individuals have no symptoms, although some may have flu-like symptoms, skin rash and swollen lymph glands.

(b) Second phase

Production of anti-HIV rises in the blood stream. Although the level of HIV in the blood falls, HIV replication continues in the lymph nodes. This phase may last from a few weeks to 13 or more years.

(c) Third phase

AIDS-related complex refers to the many **opportunistic** infections which affect the patient. These include common bacterial, fungal and viral infections such as oral and genital herpes and athlete's foot. The patient may lose weight and there is a significant drop in the number of T-helper cells.

(d) Fourth phase

More opportunistic infections and the development of secondary cancers e.g. Kaposi's sarcoma. By this time, there is almost total loss of cellular immunity.

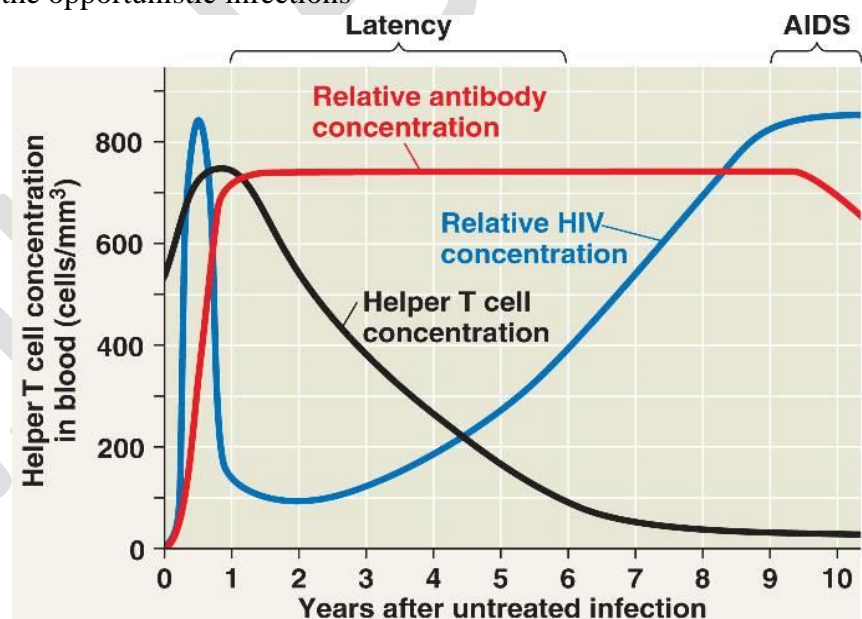

Note:

1. HIV can only survive in body fluids such as semen or blood
2. Individuals who have been exposed to HIV have circulating antibodies against the virus, and detection of these antibodies is the most common method for identifying infected individuals who are said to be **HIV-positive**.
3. HIV is not transmitted by causal contact or even kissing
4. At this time, AIDS is incurable.
5. For the present, the best approach for slowing the spread of AIDS seems to be to educate people about the practices that transmit HIV, such as unprotected sex (without a condom) and sharing needles. *Anyone* who has sex – vaginal, oral, or anal- with a partner who may have had unprotected sex with another individual during the past 15 years risks exposure to HIV.
6. Breast milk has transmitted the disease from mother to nursing infants.
7. We should avoid discriminating those of HIV i.e. stigmatism, rather we should offer help to them in any way that you can.

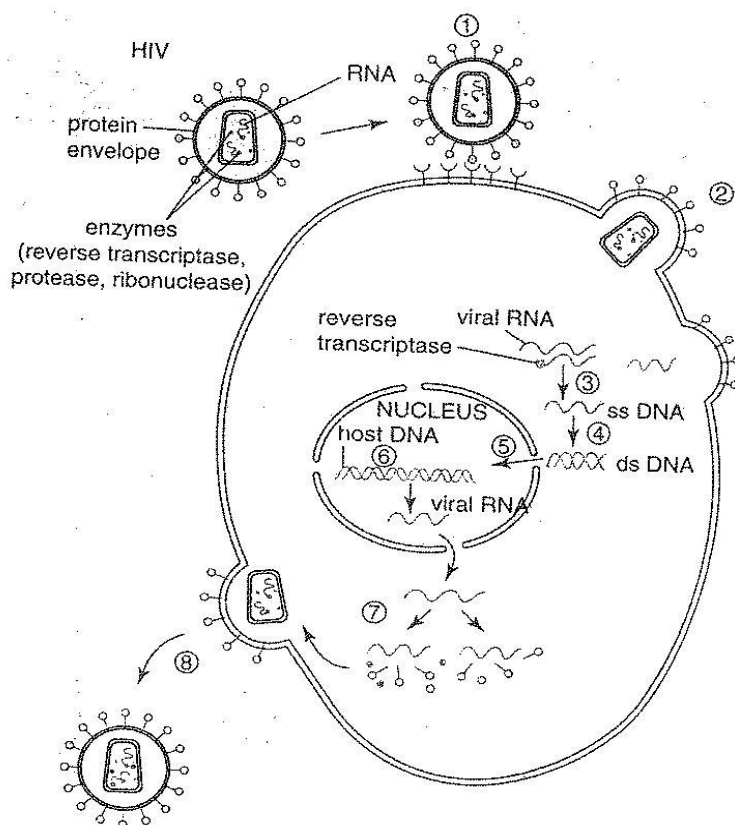

- ① HIV attaches to receptors on host cell surface membrane.
- ② HIV protein envelope incorporated into host membrane.
- ③ Reverse transcriptase used to make a single-strand DNA (ssDNA) which is complementary to the viral DNA.
- ④ ssDNA is a template for the synthesis of double-strand (ds) viral DNA → provirus
- ⑤ dsDNA incorporated into host DNA.
- ⑥ Provirus may remain dormant but is replicated each time the host cell divides.
- ⑦ Activated provirus causes the host cell to synthesise new viral protein and RNA which are then assembled into new retroviruses.
- ⑧ New retrovirus particles bud off from host cell membrane.

THE LYMPHATIC SYSTEM

The lymphatic system returns tissue fluid to the blood and also plays a role in the body defence. As blood passes through the capillaries, there is accumulative loss of fluid which is effected by ultra-filtration of blood and this forms tissues fluid that bathes cells. The lost fluid is similar to blood in composition except that of lacks blood plasma proteins and cells. The lost fluid returns the blood via the lymphatic system. It enters the system by diffusion into tiny lymph capillaries which are intermingled among the capillaries of the cardio vascular system. Once inside the lymphatic system,

the fluid is called lymph. The lymphatic system drains into the circulator system near the shoulders where it pours its contents on the **subclavian vein** that leads to the anterior vena cava.

Along the lymph vessels are specialized swellings called lymph nodes. These filter the lymph and attack bacteria, virus infected cells and other antigens using the lymphocytes in them.

When the body is infected by an antigen the cells in the **lymph nodes** multiply rapidly and the lymph nodes become swollen and tender. Like the veins of the cardio vascular system lymph vessels have valves which prevent back flow of fluids towards the capillaries. In the same way, lymph vessels depend on the movement of skeletal muscles to squeeze the fluid along the vessel.

N.B the lymphatic system serves to;

- Defend the body against infection.
- Maintains the level of interstitial fluid (tissue fluid).
- Transports fats from the digestive tract to the circulatory system (the lymph capillaries called lacteals) penetrate the villi of the small intestine which absorb the fatty acids and glycerol.

Whenever the interstitial fluid accumulates rather than being returned to the blood by lymphatic system, the tissues and body cavities become swollen a condition known as oedema.

Vaccines

Vaccines are toxic chemicals or killed or attenuated (weakened) microbes introduced into the body of an organism to make it produce very many antibodies against a certain pathogen.

The killed microbes are usually viruses and bacteria. The attenuated microbes are living microbes which are inactivated and they lack powers to infect the body due to the chemical or temperature treatment given to them.

Note; toxins are toxic chemicals produced by microbes and therefore can work as antigens

BLOOD TRANSFUSION

This is the transfer of compatible blood from the donor to the recipient.

Blood transfusion based on the ABO system of grouping blood

Blood group A has antigen A on the surface of its red blood cells and antibody b in the blood plasma of that person. Blood group B has antigen B on the surface of its red blood cells and antibody a in the blood plasma of that person. Blood group AB has antigen B and A on the surface of its red blood cells and no antibody in the blood plasma of that person. Blood group O has no antigen on the surface of its red blood cells and both antibody b and a in the blood plasma of that person.

Blood plasma permanently contains antibodies depending on a particular blood group. However these antibodies do not correspond to a specific antigen, if they correspond then agglutination occurs (precipitation of blood).

Blood group	Antigen on the red blood cell membrane	Antibody in plasma
A	A	b
B	B	a
AB	A and B	Lacks antibodies
O	No antigens	a and b

That is why an individual with blood A having antigen b cannot donate blood to an individual with blood group B having antibody a in the plasma which corresponds to antigen A to cause agglutination. Similarly, blood groups A and B cannot donate blood to an individual of blood group O because

antigen A will be attacked by antibody a in blood group O and antigen B will be attacked by antibody b in blood group O to precipitate the recipient's blood. The table below summarizes the possible blood transfusions and the impossible ones.

Individuals with blood group AB possess antigen B which stimulates blood group B of the recipient to produce antibody a that reacts with antigen A in the donor's blood to cause agglutination and therefore this transfusion from AB to B is impossible. Similarly blood group O individuals can donate blood to blood group A because the donor's blood has no antigens which would react with antigen A in the recipient's blood and therefore agglutination is impossible.

Blood group compatibilities

Recipient		Donor's blood group			
Blood group	Antibody in plasma	A	B	AB	O
A	b	✓	X	X	✓
B	a	X	✓	X	✓
AB	None	✓	✓	✓	✓
O	a and b	X	X	X	✓

✓ = compatible with recipient's blood

X = Incompatible with recipient i.e. agglutination occurs

Individuals with blood group O are called **universal donors** because they lack antigens which would react with the corresponding antibodies in the recipient's blood. Individuals with blood group AB are called **universal recipients** because they lack antibodies in their blood plasma which would have reacted with the corresponding antigens in the donor's blood.

NOTE; the recipient's antibody is the one expected to attack and react with the corresponding antigen in the donor's blood. Whenever the antigen of the donor corresponds with the antibody of the recipient's blood group, an antibody-antigen reaction occurs, leading to agglutination (precipitation or clotting of blood)

RHESUS FACTOR (D-Antigens)

These are antigens which were first observed in the bodies of the Rhesus monkeys. These antigens are also carried on the surface of the erythrocytes of some human beings. Those people with D-antigens on the surface of their red blood cells are called Rhesus positive (Rh⁺) while individuals missing such D-antigens are called Rhesus negative (Rh⁻).

The bodies of individuals do not have already manufactured antibodies against the D-antigens. When an expectant mother who is Rh⁻ bears the foetus with which is Rh⁺, some foetal erythrocytes with D-antigens will cross the placenta and enter into the blood circulation of the Rh⁻ mother towards the end of the gestation period (pregnancy). It is also possible for the blood of the foetus to mix with that of the mother during birth so that the mother gets Rh⁺ by getting the D-antigens from the child.

The D-antigens that have entered the mother's blood circulation stimulate the maternal body to manufacture corresponding antibodies (antibody-d or anti-D antibodies) which attack and react with the D-antigens in the mother. Some formed antibodies-d can also pass via the placenta and enter the foetal blood circulation where they attack and react with the D-antigens which results into clumping together and bursting of the foetal red blood cells, a condition called **erythroblastosis foetalis** (Haemolytic disease of the new born). This disease results into acute anaemia which can lead to death of the foetus.

The first born rarely dies because the time is too short for the mother to produce enough antibodies that can pass to the foetus to cause death but subsequent Rh⁺ foetus can die due to the many antibodies of the mother entering its circulation to cause agglutination.

To prevent this disease, pregnant mothers are always given anti-D chemicals 72hours to delivery, to render her immune system insensitive towards the D-antigen i.e. the mother may be infected with antibody-d within 70-72hours to delivery or within 72 hours after her first born. Also the blood of the foetus can be transfused with normal blood to dilute antibody-D so as to save the child.

NOTE: if a rhesus negative mother of blood group O is carrying a rhesus positive child of any blood group other than O, the problem will not arise. This is because if fetal cells enter the mother's circulation, the mother's **a** and **b** antibodies will destroy the blood cells before the mother has time to manufacture anti-rhesus antibodies.

N. Jude. M

UPTAKE AND TRANSPORT IN PLANTS

Water and mineral salts are necessary for photosynthetic reactions and other metabolic processes; hence they must be absorbed in sufficient quantities by using the root system and transporting them through the xylem to the mesophyll cells of leaves where photosynthesis takes place. Leaves have a large surface area to absorb light, and stomata to allow adequate inward diffusion of carbon dioxide, both result in an immense loss of water.

Water is lost from the mesophyll cells into sub-stomatal air chambers and then eventually lost into the atmosphere of water vapour through tiny pores called “stomata” by a process known as **transpiration**.

TRANSPIRATION

This is the process of water loss in form of water vapour to the atmosphere from the plant mainly through the stomata pores.

Types of transpiration

There are three types of transpiration which include the following (a) Stomatal transpiration (b) Cuticular transpiration & (c) Lenticular transpiration

Stomatal transpiration

This is the loss of water vapour to the atmosphere through the stomatal pores of the leaves. This contributes 90% of the total water loss from a leafy shoot. This is because leaves contain a large number of stomata for gaseous exchange where this water vapour can pass and also there's little resistance to the movement of water vapour through the stomatal pores. In addition, leaves also have a large surface area over which water vapour can evaporate rapidly to the atmosphere.

Cuticular transpiration

This is the loss of water vapour to the atmosphere directly through the epidermis coated with a cuticle layer. It contributes 5% to the total water loss from the leafy shoot. This is because the cuticle is hard, waxy and less permeable to most diffusing molecules including water vapour molecules.

Lenticular transpiration

This is the loss of water vapour through a mass of loosely packed cells known as lenticels found scattered on the stems. It also contributes 5% of the total water loss to the atmosphere in a leafy shoot. It is because the lenticels are usually few in number and not directly exposed to environmental conditions. Lenticular transpiration is the main source of water loss from deciduous plants after shading off their leaves. Because there are more stomata on the leaves than elsewhere in the shoot system, it is evidence that most of the water vapour is lost from the leaves.

In order to establish that transpiration occurs mostly in the leaves, an experiment using absorptive paper, dipped Cobalt II Chloride solution or Cobalt II thiocyanate solution is carried out. The paper is covered on the surface of both sides of the leaves and then clamped with glass slides. After some time, the blue cobalt thiocyanate paper changes to pink, indicating the evaporation of water molecules from the leaf by transpiration. The rate of change from blue to pink is higher at the lower epidermis than the upper epidermis. This is because structurally there are more stomata on the lower epidermis to prevent excessive loss of water by transpiration due to direct solar radiation

Measuring the rate of transpiration

The rate of transpiration can be measured by either determining the rate of transpiration at which the plant loses mass due to water loss or the rate at which the plant takes in water (water uptake), using an instrument called a potometer.

Determining the rate of transpiration using

a. the weighing method

The rate of mass loss by the plant can be determined by using the potted plant placed on an automatic weighing balance whereby the change in mass is noted over a given period of time. Using this method, it is assumed that the mass loss is only due to water loss by transpiration. However, the whole pot must be enclosed in a polythene bag to prevent water from evaporating from the soil. In addition, the soil must be well watered before the beginning of the experiment so that the plant has enough water throughout the experiment. The rate of transpiration is then expressed in terms of mass lost per unit time

b. the potometer

The potometer is used to measure the rate of water uptake by the shoot of the leafy plant.

However, since most of the water taken up is lost by transpiration, it is assumed that water uptake \approx water loss. The leafy shoot is cut under water to prevent the air bubbles from entering and blocking the xylem vessels. The cut leafy shoot is immediately fixed in the sealed vessel and connected to the capillary tube. The rate of water uptake is then measured by introducing an air bubble at the end of the graduated capillary tube and the distance moved by the air bubble per unit time is noted.

To drive the air bubble back to the original position, water is introduced into the capillary tube from the reservoir by opening the tap on the reservoir.

The leafy area is also established by tracing the outline of the leaves on a squared graph paper and then counting the number of complete and incomplete squares enclosed in the outline

$$\begin{array}{rcl} \text{Total area of} & & \text{Number of} \\ \text{leaves} & = & \text{complete squares} \\ & & + \text{Number of incomplete} \\ & & \text{squares} \times \frac{1}{2} \end{array}$$

The rate of transpiration is therefore expressed in terms of the volume of water taken up by the leafy shoot per unit time per unit leaf area. The structure of a potometer is shown in the diagram above.

Precautions taken when using a potometer

- The leafy shoot used should have a significant water loss by having very many leaves
- The stem of the leaf shoot must be cut under water to prevent air from entering and blocking the xylem vessels
- The setup must have plenty of water

(Kent Fig 2 pg 276, Soper Fig 13.10 pg 439, Toole fig 22.12 pg 457)

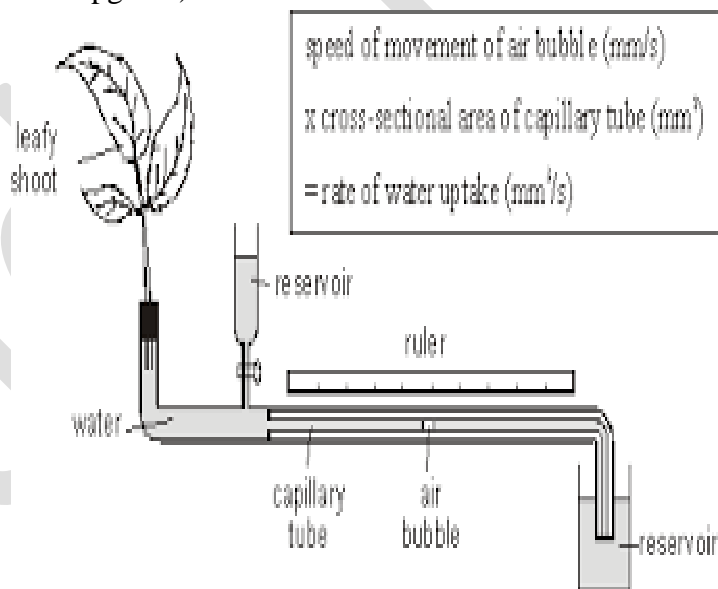

- d. Ensure that only one bubble is present in the capillary tube
- e. A well graduated scale must be used e.g. a ruler, so that clear readings are taken
- f. The air bubble should always be reset to zero mark before the potometer is used again under different conditions
- g. The water reservoir should be filled with water when setting the air bubble at the zero mark
- h. The cut leafy shoot must be in contact with water in the sealed vessel

How to use a potometer

- a. The leafy shoot is cut under water to prevent air bubbles from entering and blocking the xylem vessels. The cut leafy shoot is immediately fixed in the sealed vessel of water connected to a capillary tube. Allow time (5 minutes) for the apparatus to equilibrate. The rate of water uptake is measured by introducing the air bubble at the end of the graduated capillary tube and the distance moved by the air bubble per unit time is noted.
- b. To drive the air bubble back to the original point, water is introduced into the capillary tube from the reservoir by opening the tap.
- c. The leafy area is then established by tracing the outline of the leaves on squared papers and then counting the number of complete and incomplete squares in the outline of the leaves.
- d. The rate of transpiration is therefore expressed in terms of the volume of water taken up by the leafy shoot per unit time per leafy area.

NOTE; since most of the water taken up by the potometer is lost by transpiration, it is assumed that water uptake = water loss.

Advantages of transpiration

- a. It allows the uptake of water from the roots to leaves in form of a transpiration stream. This is due to a transpiration pull created in the leaves. This ensures proper distribution of water throughout the plant to keep it alive.
- b. It facilitates the uptake of the absorbed mineral salts within the xylem vessels from roots to leaves
- c. It brings about the cooling of the plant since as water evaporates to the atmosphere, excessive heat is also lost as heat of vaporization, which results into the cooling of the plant
- d. It brings about mechanical support in non-woody or herbaceous plants, due to water uptake which provides turgidity to the parenchyma cells of the stem and leaves
- e. It is important for cloud formation via evapotranspiration hence resulting into rainfall

Disadvantages of transpiration

- a. It causes wilting of plants in case of excessive transpiration
- b. It may eventually cause death of the plant, when the plant loses water excessively due to excessive transpiration

NOTE: wilting is the drooping of leaves and stems as a result of plant cells losing water osmotically and becoming flaccid. Evaporation occurs at rate greater than that at which it is absorbed, resulting into reduction in turgor pressure and drooping of the plant. It always takes place in hot and dry areas. Wilting also results into the closure of the stomata which cuts off gaseous exchange and therefore may cause death if it persists.

FACTORS AFFECTING TRANSPIRATION

The potometer may be used to investigate the effect of environmental factors on the rate of transpiration i.e. it can be moved to a windy place or a place which is dark. Transpiration is affected by both environmental and non-environmental factors.

ENVIRONMENTAL FACTORS

1. Humidity

The humidity of the atmosphere affects the gradient of water vapour between the sub-stomatal air chamber and the atmosphere around the leaf i.e. it affects the rate of diffusion of water vapour.

Low humidity (low water vapour pressure) outside the leaf increases the rate of transpiration because it makes the diffusion gradient of water vapour from the moist sub-stomatal air chamber to external atmosphere steeper.

When humidity is high in the atmosphere, the diffusion gradient or the water vapour pressure gradient is greatly reduced between the sub-stomatal air chamber and the atmosphere which results into reduction in the rate of transpiration.

In areas where humidity is too high, plants lose liquid water from their leaves via structures/glands on their leaf margins known as hydathodes, a process known as guttation. **Guttation** is the loss of liquid water from plant leaves (exudation) through hydathodes due to excessive humidity in the atmosphere. Guttation is common in young grass seedlings and rain forest plants due to the dim light and high humidity.

2. Temperature

Increase in temperature increases the rate of water loss by the leaves via transpiration. A decrease in temperature lowers the rate of water loss by the plant leaves via transpiration.

This is because (a) increase in temperature increases the heat energy which provides the latent heat of vaporization of water molecules hence the water molecules evaporate rapidly to the sub-stomatal chambers and eventually to the atmosphere via the stomata (b) increase in temperature also lowers humidity outside the leaf by increasing the random thermal movement of molecules in the water vapour which further increases the rate of transpiration.

In extremely hot conditions, the stomata of some plants close, an adaptation to prevent water loss by transpiration.

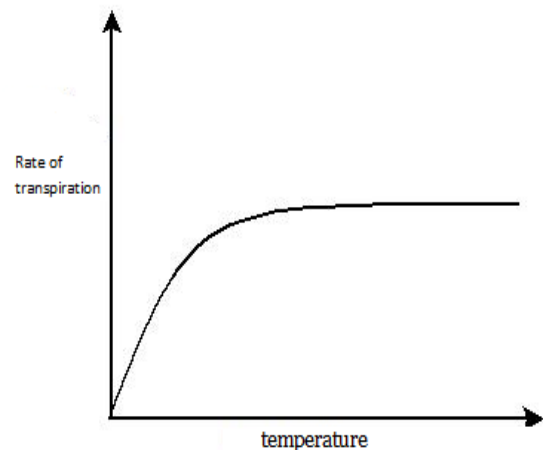

3. Air movements

In still air (no wind), layers of highly saturated vapour build up around the stomatal pores of the leaf and reduce the diffusion gradient between the stomatal air chamber and the external atmosphere, thereby reducing the rate of diffusion of water vapour from the leaf.

The layers of highly saturated water vapour which build up around the stomatal pores of the leaf are called **diffusion shells**.

Windy conditions result in increased transpiration rates because the wind sweeps away the diffusion shells around the leaf, thereby creating a steep diffusion gradient which leads to a high transpiration rate

(Soper fig 13.9 pg 439)

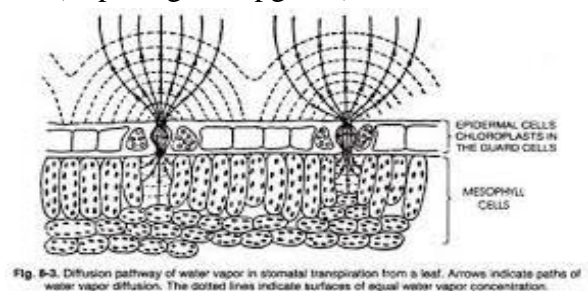

Fig. 8-3. Diffusion pathway of water vapor in stomatal transpiration from a leaf. Arrows indicate paths of water vapor diffusion. The dotted lines indicate surfaces of equal water vapor concentration.

4. Atmospheric pressure

Water vapour and the atmospheric pressure decreases with increasing altitude.

The lower the atmospheric pressure the greater the rate of evaporation of water from the sub-stomatal air chamber. This implies that plants growing on a mountain have a higher rate of transpiration than those growing in low land areas.

However, when the atmospheric pressure is high e.g. in the lowland areas, the evaporation of water vapour from the sub-stomatal air chamber to the atmosphere decreases, thereby decreasing the rate of transpiration.

5. Water availability

For water vapour to diffuse out of the sub-stomatal air chamber to the atmosphere, the mesophyll cells must be thoroughly wet. Shortage of water in the soil or any mechanism which hinders the uptake of water by the plant leads to **wilting** of the plant hence the closure of the stomata.

When water is supplied in large amounts, too much water evaporates to the atmosphere and therefore a high rate of transpiration. However, when the water supply to the mesophyll cells is low, less water evaporates from the sub-stomatal to the atmosphere, hence a low rate of evaporation.

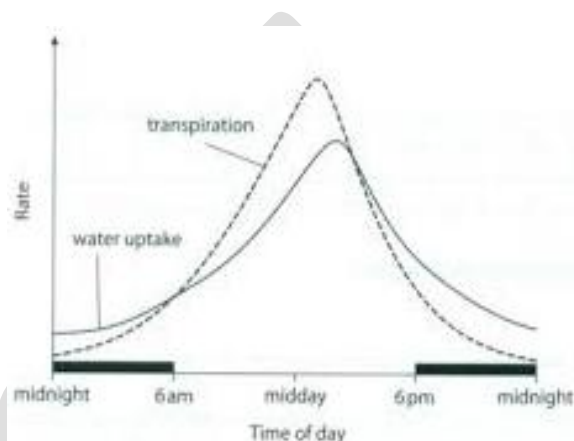

QN. What is the relationship between transpiration and water up take?

6. Light intensity

It affects transpiration indirectly by affecting the closure and opening of the stomata, which usually opens in bright sunlight to allow evaporation of water to the atmosphere. Therefore sunlight increases the rate of transpiration.

At night and in darkness, the stomata close and therefore there is no evaporation of water from the sub-stomatal air spaces to the atmosphere. This greatly lowers the rate of transpiration in the plant.

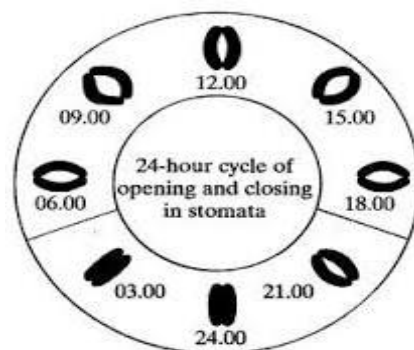

Differences between transpiration and guttation

Transpiration	Guttation
1. Water is lost in form of vapour	1. Water is lost in form of droplets
2. Occurs through the stomata, cuticle and lenticels	2. Occurs through the hydathodes
3. Occurs during bright light and high temperatures	3. Occurs during dim light and low temperatures
4. Enhanced by low humidity	4. Enhanced by high humidity
5. Water lost is pure without mineral salts	5. Water lost is mineral water with sugars, salts and amino acids
6. Increased transpiration causes wilting	6. Increased guttation does not cause wilting

NON-ENVIRONMENTAL FACTORS

Leaf area

The larger the leaf surface area on the plant, the higher the rate of water loss by transpiration. In addition, broad leaves provide a large surface area over which water vapour diffuses to the atmosphere as compared to the narrow leaves.

Number of stomata

The larger the number of stomata on the plant, the higher rate of water loss by transpiration and the lower the number of stomata, the lower the rate of transpiration. However, a very large number of stomata so close to each other may instead reduce the rate of transpiration especially in still air due to the accumulation of water vapour around the whole stomata pore.

Distribution of stomata

The upper surface is more exposed to environmental factors that increase the rate of transpiration.

Cuticle

The thinner the cuticle, the higher the rate of water loss by transpiration and the thicker the cuticle, the lower the rate of water loss from the plant to the atmosphere by transpiration. This is because this offers a significant resistance towards the diffusion of water vapour from the plant to the atmosphere

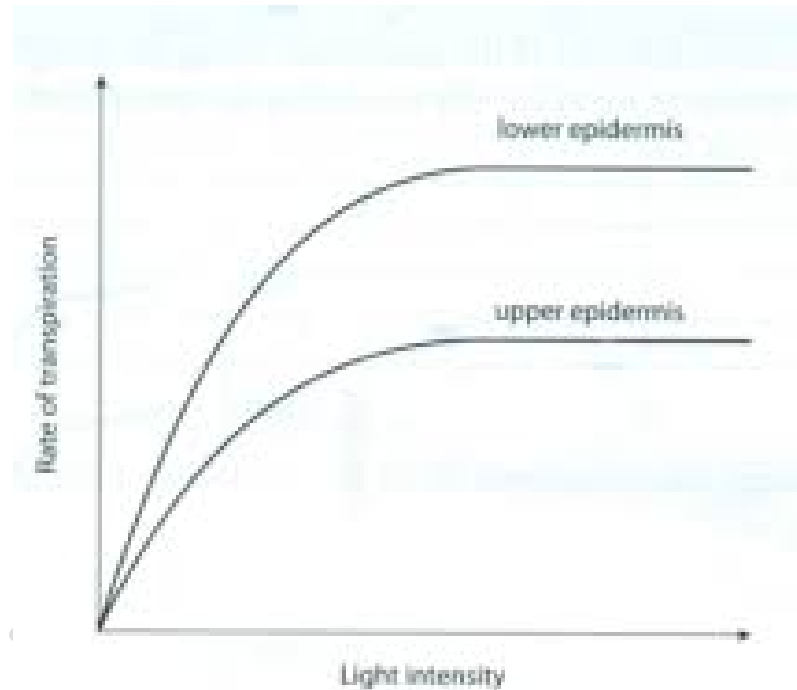

Xerophytic adaptations of leaves that reduce transpiration

Xerophytes (xero = dry, phyte = plant) are plants that are adapted to living in areas where water losses due to transpiration may exceed their water uptake. Similar adaptations may also be seen in plants found in dry, windy places, where rainfall is high and temperature relatively low. As the vast majority of transpiration occurs through the leaves, it is these organs that show most modifications.

Examples include;

- Having a thick cuticle. The thicker the cuticle, the less water can escape by this means.
- Curling up of leaves. A region of still air is trapped within the curled leaf. This region becomes saturated with water vapour and so there is no water potential gradient between the substomatal air space and the outside, and so transpiration is considerably reduced.
- Having hairy leaves. A thick layer of hair, especially on the lower epidermis, traps moist air next to the leaf surface which reduces the water potential gradient between the inside and the outside of the leaf, therefore less water is lost.
- Having stomata in pits or grooves. These trap moist air next to the leaf and reduce the water potential gradient.
- Reducing the surface area to volume ratio e.g. the cacti leaves are in form of thorns

- f) Closing stomata when transpiration rate is very high. This is done by the release of abscisic acid.

STOMATA

In terrestrial plants, gaseous exchange takes place predominantly in the leaves. The epidermis of the leaves contains small pores called stomata (singular. stoma). Through stomata, gaseous exchange between the inside of the leaf and the outside air takes place by diffusion.

The broad leafed shape of the leaf offers a large surface for diffusion of gases, its thinness reduces the distances over which diffusion of gases from the atmosphere to the inner most cells.

In most terrestrial plants, stomata are more abundant on the lower side than the upper surface of the leaf. This reduces water loss through transpiration since the upper surface is exposed to direct sunlight. The number of stomata in leaves vary from one plant species to another. They are normally absent in submerged leaves of water plants.

Structure of the stoma

Each stoma consists of a stomatal pore, bordered by a pair of crescent or bean-shaped cells called guard cells. Unlike epidermal cells, guard cells contain chlorophyll. The inner cell wall of guard cells is thicker and less elastic than the outer wall. Microfibrils are radially orientated in the cell wall and the guard cells are joined at the ends. The epidermal cells surrounding the guard cells are subsidiary cells.

(Toole fig 22.7a pg 452)

(Toole fig 22.7b pg 452)

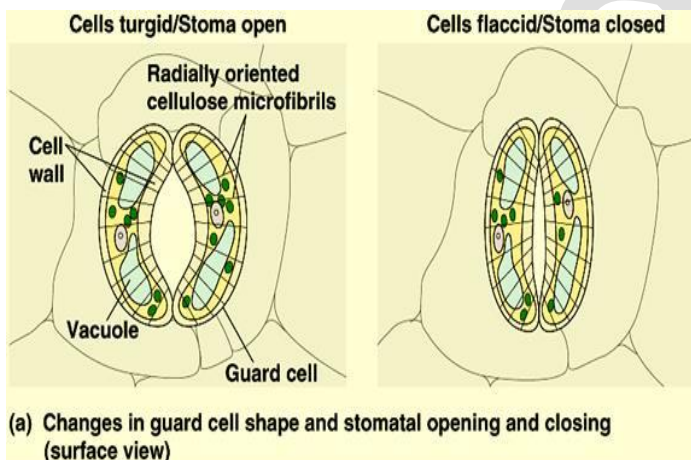

(Soper fig 13.15 pg 444)

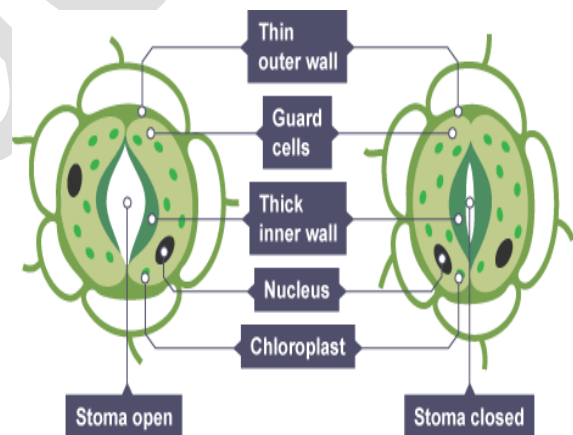

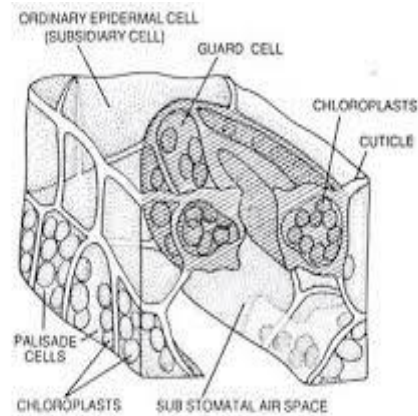
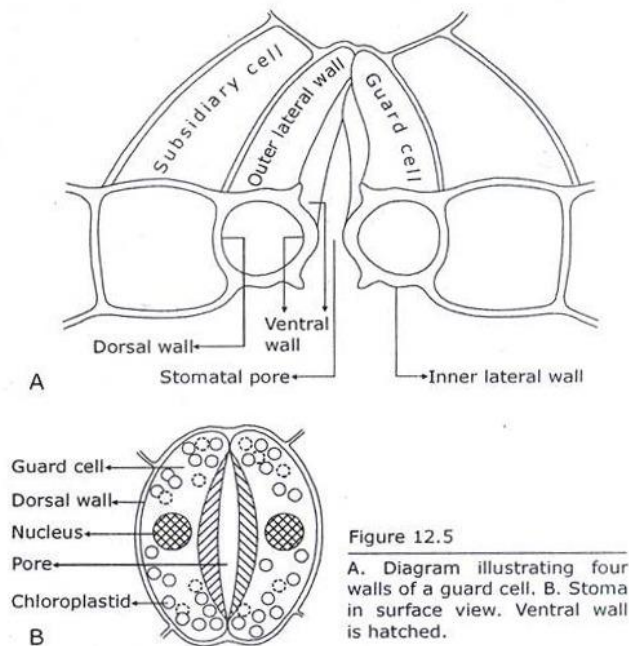

Ventilation (opening and closing of stomata)

The opening and closing of stomata occurs as a result of changes in the shape of the guard cells. When guard cells take in water by osmosis, they expand and become turgid. However, they do not expand uniformly in all directions. The thick inelastic inner wall makes the guard cells to curve away from each other, opening the stoma. When the guard cells lose water, they become flaccid and collapse, closing the stomata.

The closing and opening is controlled mainly by the intensity of light. They are normally open during daylight and closed during the night.

Several theories have been put forward to explain how the light intensity influences the opening and closing of stomata.

a. Starch sugar inter conversion

This is one of the earliest theories that attempted to explain the control of stomata closure.

- Photosynthesis by mesophyll cells during daylight would remove carbon dioxide from air spaces within the leaf
- Since carbon dioxide is an acidic gas, removal of carbon dioxide raises the pH of the guard cells
- Starch hydrolyzing enzymes in the guard cells work better in alkaline conditions, and they convert starch to sugar
- Accumulation of sugar makes the water potential of the guard cells more negative, causing a net influx of water into the guard cells and opening the stomata.

Note: a starch hydrolyzing enzyme, starch phosphorylase that is affected by pH was found **but** some plants e.g. the onion do not form starch at all.

b. Photosynthetic product theory

- Guard cells have chloroplast.
- During day light, they carry out photosynthesis producing sugar.

- The sugar increases the osmotic pressure of the cell sap. This causes water to move into the guard cells from neighbouring epidermal cells by osmosis. The result is an expansion and increase in turgidity of the guard cells containing the stomata to open.
- In darkness, photosynthesis stops and the sugar in the guard cells is converted to starch. This lowers the osmotic pressure of guard cells causing them to lose water to neighboring cells by osmosis.
- The guard cells become flaccid and the stomata close.

Note; this theory does not explain how the low rate of glucose formation can account for the rapid opening of stomata

c. Potassium ion (K^+) mechanism (mineral ion concentration)

- When guard cells are exposed to light, the light energy activates the ATPase enzyme, hence their chloroplasts manufacture ATP.
- The ATP drives a K^+ - pump on the cell membrane of the guard cells. This causes an active uptake of K^+ ions in the guard cells from the surrounding epidermal cells.
- Accumulation of K^+ in the guard cells increases the osmotic pressure of their cell sap. This causes water to move into the guard cells from neighboring epidermal cells by osmosis. The result is an expansion and increase in turgidity of the guard cells causing the stomata to open because when they become turgid, they expand but not uniformly since the inner wall is inelastic, making the guard cells curve away from each other.
- At the onset of darkness, ATP concentration in guard cells falls rapidly stopping the K^+ pump. K^+ migrates from the guard cells to neighboring epidermal cells by diffusion. This lowers the osmotic pressure of guard cells causing them to lose water to neighboring cells by osmosis.
- The guard cells become flaccid and the stomata close.

Note; the above theory is the most widely accepted theory today. It is supported by the fact that the opening of stomata is prevented by metabolic poisons which inhibit active transport.

(Toole fig 22.8 pg 452 OR Kent fig 3 pg 281)

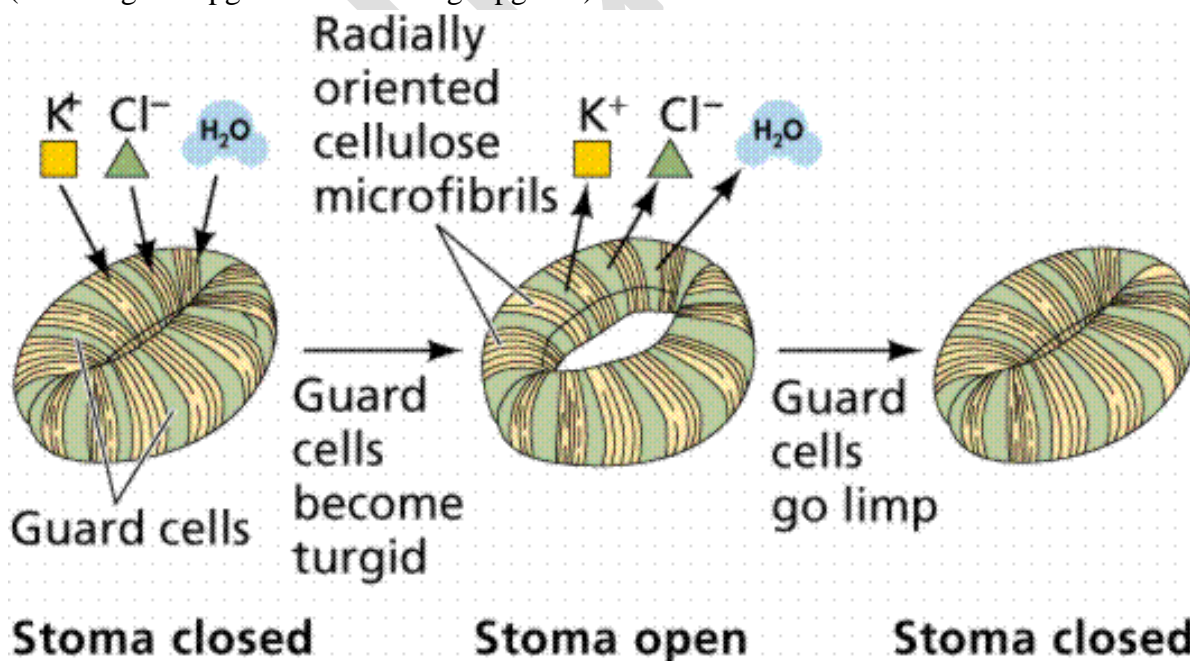

The above theories can be summarised into a single mechanism of stomata opening and closing as described below;

Stomata opening

- a. Stomata opening is promoted by high light intensity and low mesophyll carbon dioxide levels. Guard cells generate ATP by photophosphorylation during photosynthesis. .
- b. Blue light is absorbed by blue-light photoreceptors which activate a proton-pump (H^+ -ATPase) in the cell membrane of the guard cell
- c. ATPs generated by the light-dependent reaction of photosynthesis are hydrolysed to provide energy to drive the proton-pump. As protons (H^+) are pumped out of the guard cells, the cells become increasingly negatively charged. Potassium channels are activated and K^+ ions diffuse from subsidiary cells through the channels down this electrochemical gradient into guard cells. Chloride ions (Cl^-) then enter to balance the charge.
- d. In some plants the starch is converted to malate.
- e. The accumulation of K^+ (and malate ions) causes the water potential in the guard cells to become more negative. Water enters by osmosis from the neighbouring subsidiary cells into the guard cells. The guard cells become turgid.
- f. The outer wall of the guard cells is thinner and more elastic than the thicker inner wall. There are cellulose micro fibrils which are radially arranged around the cell wall and the ends of the two guard cells are joined
- g. The increased turgor pressure therefore causes the guard cells to curve outward and the stoma opens

Stomata closure

- a. Stomata closure can be triggered by water stress, high temperature, increasing carbon dioxide levels in the leaf mesophyll and low light intensity (night time)
- b. The hormone abscisic acid (ABA) is secreted by plant cells when transpiration rate is high and soil water is low.
- c. ABA binds to receptors at the cell membrane of the guard cells. This increase the permeability of calcium channels in the cell membrane. Calcium ions (Ca^{2+}) enter into the guard cell. The influx of calcium ions also triggers the release of Ca^{2+} from the cell vacuole into the cytosol.
- d. Potassium ions (K^+) move out of the guard cells into the subsidiary cells
- e. In some plants (Cl^-) and certain organic ions e.g. malate ions also move out of the guard cells
- f. The water potential in the guard cells increase. Water diffuses out to neighbouring subsidiary cells by osmosis. The turgor pressure in the guard cells decreases, the cells become flaccid and the stoma closes.
- g. At night the chloroplasts in the guard cells do not photosynthesise, less ATP is produced and there's no active uptake of K^+ ions. Instead, the K^+ ions diffuse out of the guard cells. The cells become flaccid and the stoma closes.

Importance of stomata

1. Stomata allow gaseous exchange of carbon dioxide (for photosynthesis) and oxygen (for respiration) between the plant and the surrounding
2. Stomata regulate the rate of transpiration and control water loss by the plant
3. When water is lost through the stomata, it creates a transpiration pull which can pull the water and mineral salts from the roots to the higher parts of the plant. Transpiration also has a cooling effect on the plant.

LENTICELS

A small extent of gaseous exchange takes place in the stem through structures called lenticels.

The small gaps in the stem, usually circular or oval slightly raised on the bark surface. The cells in this area are thin walled and loosely parked, leaving air spaces which communicate with air spaces in the cortex. Here oxygen for respiration is taken up and carbon dioxide is given out.

Structure of the lenticel

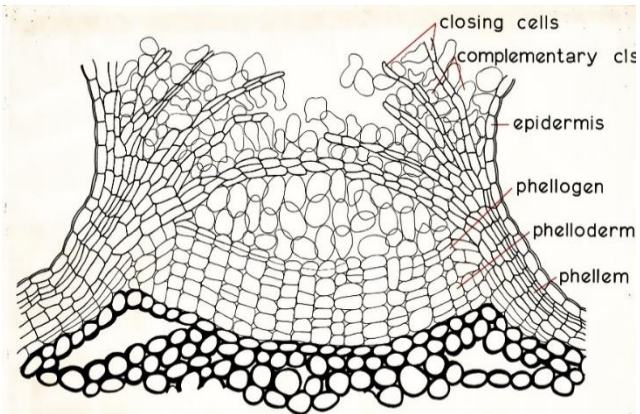

ROOT EPIDERMAL CELLS

Root cells can also take in oxygen for respiration and give out carbon dioxide. Gaseous exchange takes place by diffusion between the epidermal cells of roots and the air spaces in the soil. Most of the exchange takes place at the root hairs which provide a large surface area.

Water logged soils have their air spaces occupied by water, thereby reducing respiration in the roots which may subsequently die. This would obviously kill the whole plant.

Some aquatic plants, like pond weeds and multi cellular algae are completely submerged in water. These obtain their gaseous requirements by diffusion from the surrounding water. Epidermal cells of such plants have no cuticle and gasses diffuse directly across it.

Others like rice and water lilies are partially submerged in water. Their aerial parts obtain carbon dioxide and oxygen in the same manner as terrestrial plants. The submerged parts may face the problems of obtaining adequate oxygen for their respiratory requirement. However such plants have large air spaces in their stems and roots which store oxygen obtained from the aerial parts and that formed during photosynthesis. Floating leaves of such plants have stomata on the upper surfaces only.

In swampy environments, root systems give rise to breathing roots or pneumatophores. These grow out of the water and up into the air. Oxygen diffuses into them and aerates the submerged parts of the root system.

EXPERIMENT TO OBSERVE STOMATA

Obtain a leaf of comelina. Hold it in such a way that the lower surface is facing you. Slowly tear the leaf as you would tear a piece of paper by moving the right hand towards the body. This produces a thin, transparent membrane-like tissue along the edge of the tear on the part of the leaf in the left hand. This is the lower epidermis. Using forceps, remove a small section of the epidermis and mount it in a drop of water on a slide and cover it with a cover slip. Observe under low power and then under the high power of a microscope. Identify the guard cells and the normal epidermal cells. Observe a closed stoma and an open stoma under low and high power. Draw each of these

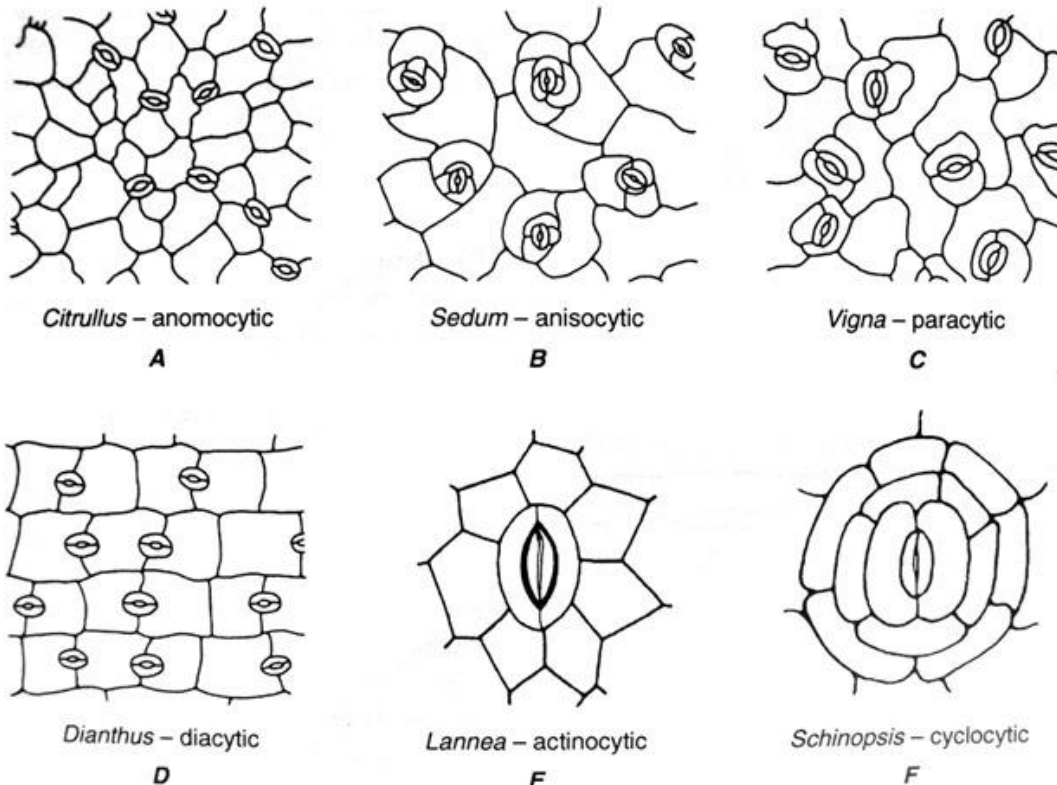

WATER UPTAKE BY THE ROOTS

Internal structure of the root

The root consists of various tissues which occur in concentric layers. The cells at the surface of the young root forming the peliferous layer are so called because it is by the root hairs. As the roots get older, they increase in girth (thickness or diameter) and the peliferous layer (breaks) raptures and peels off leaving the outer most layer of cells known as epiblem, to become the functional outer layer.

Next to the epiblem is the thicker layer of loosely packed parenchyma cells, known as **cortex**. Adjacent to the cortex is a layer of cells known as endodermis.

The endodermal cells have their radial and horizontal walls coated with a corky band called **casparian strip**. This strip is made up of a substance called **suberin**. The Casparian strip is impermeable to water and solutes due to the suberin that it contains and therefore prevents water and solutes to pass through the cell walls to the endodermis. The endodermis also contains starch grains.

Next to the endodermis is another layer of cells known as pericycle from which lateral roots develop. The pericycle, that is made up of parenchyma cells which encloses the vascular bundles (xylem and phloem) in the centre of the root.

Diagram showing the internal structure of the root

(Toole fig 22.13a pg 462)

(Toole fig 22.13b pg 462)

Longitudinal section through a root

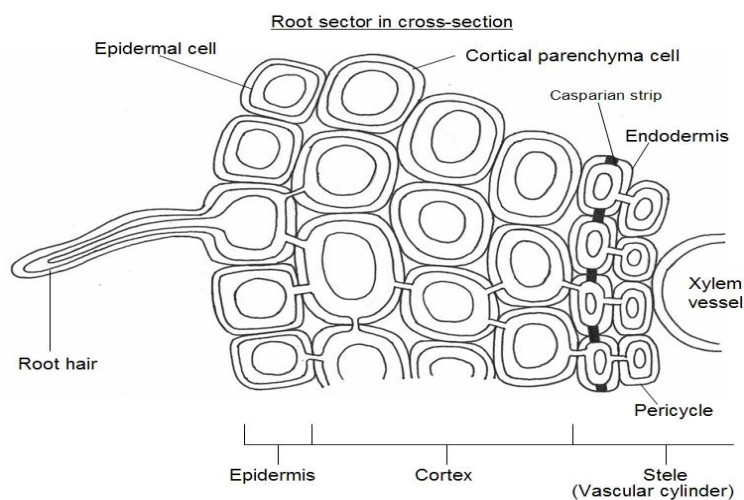

Mechanism of water uptake by the roots

For water to be transported up to the leaves through the stem, it must be absorbed from the soil by the tiny root hairs. Water absorption into the root hairs occurs by **osmosis**. This is due to the water potential of the cell sap of the root hairs being lower than that of the soil solution (water content) due to the very low concentration of mineral ions in water and the soil particles. The cells of the root hairs have a relatively higher concentration of ions, sugars and organic acids within their vacuoles and cytoplasm hence a lower water potential (more negative).

When the root hair absorbs water, its water potential increases and becomes higher than that of the adjacent cells of the root. This facilitates the flow of water from the root hairs to the endodermal cells across a water potential gradient.

The water flow is also due to the root pressure developed by the cell cortex and endodermis which ensures that water flows from the root hairs to the xylem vessels and upwards to the leaves.

Water flows by osmosis from the root hairs to the endodermal cells using three pathways, namely; **(a)** Apoplast (cell wall) pathway, **(b)** Symplast (cytoplasm) pathway & **(c)** Vacuolar pathway

Apoplast pathway

This is the pathway in which water moves through the **spaces** between the cellulose fibres in the cell wall of one cell to the cell wall of the adjacent cells. The **cohesive** forces between the water molecules enable the stream of water to be pulled along the apoplast pathway.

However, this movement does not occur within the endodermal cells because they possess the impermeable water proof band of **suberin** that makes up the **casparian strip**. The casparian strip prevents water and solutes flow through the cell walls of the endodermal cells. This means that water and solutes flow through the cell walls of the endodermal cells via the Symplast and the vacuolar pathways only.

The significance of this casparian strip is that endodermal cells actively pump salts (ions) from the cytoplasm into the xylem vessels which creates a high solute concentration in the xylem, thereby greatly lowering the water potential in the xylem than in the endodermis. This makes the water potential of the xylem vessels more negative (very low) and results into rapid osmotic flow of water from the endodermal cells to the xylem vessels, due to the steep water potential gradient between the endodermal cells and the xylem vessels. This positive hydrostatic pressure is known as the **root pressure**.

The casparian strip facilitates the pushing of water upwards through the xylem vessels by root pressure up to the leaves due to its active pumping of the salts. In addition, this active pumping of the salts into the xylem vessels prevents leakage of salts (ions) out of the xylem vessels so as to maintain a low water potential in this vessel.

Note, in some short herbaceous plants, root pressure is strong at times e.g. at night when humidity is high to cause exudation of water droplets from hydathodes at the edges of leaves. This is known as **guttation**.

Symplast pathway

This is the movement of water through the cytoplasm of one cell to the cytoplasm of the adjacent cell via plasmodesmata along a water potential gradient. Water leaving the pericycle cells to enter the xylem causes the water potential of these cells to become more negative (more dilute). This facilitates the flow of water by osmosis from the adjacent cells into these cells. In this way the water potential gradient from the root hairs to the xylem is established and maintained across the root. This pathway offers a significant resistance to the flow of water unlike the apoplast pathway.

Vacuolar pathway

This is the movement of water from the sap vacuole of one cell to the sap vacuole of the adjacent cell through the cytoplasm, vacuoles as well as the cell wall following a water potential gradient.

This is achieved by maintaining a steep water potential gradient. However, this also offers a reasonable level of resistance towards water flow in comparison to the Symplast pathway.

Note; the apoplast is the most appropriate pathway in plants because it provides less resistance to water flow in the plant.

Diagram showing the three pathways of water in the root

(Soper fig 13.18a pg 448)

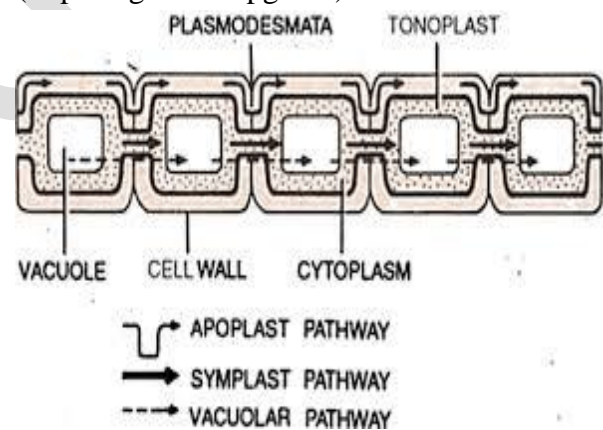

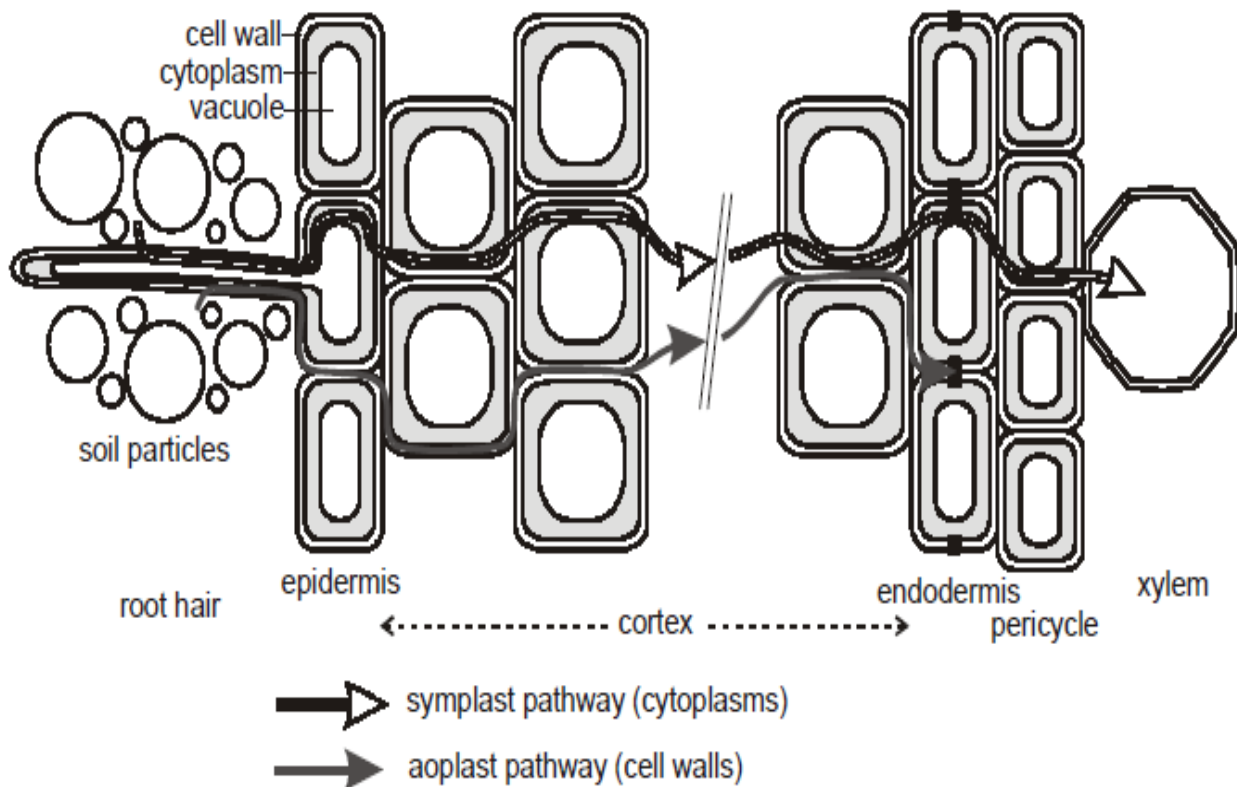

To ensure maximum absorption of water, the root hairs have the following adaptations

- They are numerous in number so as to provide a large surface area for the maximum absorption of water by osmosis.
- They are slender and flexible for easy penetration between the soil particles so as to absorb water.
- They lack a cuticle and this enhances the passive osmotic absorption of water without any resistance.
- They have a thin and permeable membrane which allows the absorption of water by osmosis.
- They have a water potential lower than that of the soil solution which facilitates a net osmotic flow of water from the soil.
-

Vascular tissues

The transport system in plants is made up of the **xylem** (which carries water from roots, up the plant from the aerial parts) and **phloem** (which carries sugars produced by leaves to other parts of the plant). The two tissues occur together throughout the plant, sometimes associated tissues, such as **sclerechyma fibres**, to form discrete areas, known as **vascular bundles**.

a) Distribution of vascular tissues in a leaf

The vascular tissues in a dicotyledonous leaf form a network of tiny vascular bundles throughout the blade, or **lamina**, of the leaf. These tiny bundles fuse to give a series of **side veins** that run parallel with one another. These side veins then merge into a central **main vein**. The main vein runs along the centre of the leaf, increasing in diameter towards the petiole, or leaf stalk. Within in each, or vascular bundle, there is an area of xylem towards the upper surface of the leaf and an area of phloem towards the lower surface.

b) Distribution of vascular tissues in a stem

The xylem and phloem in a dicotyledonous stem form vascular bundles that are arranged towards the outside of the stem. The reason for this is that the vascular bundles, along with associated sclerechyma fibres, not only transport materials but also provide support in

herbaceous plants. The main forces acting on stems are lateral one caused by the action of wind on them. Such forces are best resisted by an outer cylinder of supporting tissue. Hence the vascular bundles form a discontinuous ring towards the edge of them. Being discontinuous, this ring of supporting tissues allows the stems to be flexible and to bend in wind. Within the vascular bundles, the xylem is to the inside of the stem and the phloem towards the outside. Between the two is a thin layer of dividing cells called cambium, which give rise to both phloem and xylem.

c) **Distribution of vascular tissues in a root**

The vascular tissue in the root of a dicotyledonous plant is situated centrally rather than towards the outer edge, as in a stem. This is because roots are subject to pulling forces in a vertical direction, rather than in a lateral direction, as experienced by stems. Vertical forces are better resisted by a central column of supporting tissues, such as xylem, rather than an outer cylinder of tissue. The xylem is typically arranged in a star-shaped block of tissue at the centre of the root, with the phloem situated in separate groups between each of the points of the star-shaped xylem. Around both is the **pericycle** and **endodermis**.

The xylem.

The xylem is the principle water-conducting tissue in vascular plants. It also provides support for plants. The **sclerechyma fibres** in the xylem contribute to support whereas **vessels** and **tracheids** have both support and transport roles.

- a) **xylem fibres** are elongated sclerechyma cells with walls that are thickened with **lignin**; these features suit them for their role of support
- b) **vessels** vary in structure, depending on the type and amount of thickening of their cell walls, but are all hollow and elongated. As they mature, their walls become impregnated with lignin, which causes them to die. The end walls breakdown to form a perforation plate which allows the cells form a continuous tube. The lignin maybe spiral/network/reticulate or annular/ring in form; these arrangements are better than continuous thickening, because allows elongation of vessels as the plant grows. There are areas of the lignified wall where lignin is absent, called **pits**. They are not completely open as there is still a cellulose cell wall across them. Pits allows lateral (sideways) movement of water. In angiosperms, vessels are the structures through which the vast majority of water is transported.

c)

Adaptations of the xylem structure to its function

- the cells are long and arranged end to end to form a continuous column
- the cell contents die when mature, which means that:
 - there is no nucleus or cytoplasm to prevent water flow
 - the end walls break down, so that there is no barrier to water flow between adjacent cells
- cells are thickened with lignin, which
 - makes them more rigid and therefore less likely to collapse under the tension created by the transpiration pull
 - increases the **adhesion** of water molecules, enabling them to rise by capillarity

- annular, reticulate and spiral thickening allow xylem vessels to elongate during growth, and make them more flexible, so that branches can bend in the wind
- there are pits throughout the cells, to allow lateral movement of water
- the large **lumen** of the vessels allows a large volume of the water to be transported

Other xylem tissues

- Xylem parenchyma** is composed of unspecialized cells that act as packing tissue around the other components of the xylem. They are roughly spherical in shape, but when they are turgid they press upon and flatten each other in places. In this way they provide support.
- Tracheids** have similar structures to vessels except that they are longer and thinner, and have tapering ends. They, too, are thickened with lignin and therefore die when mature. As with vessels, the end walls break down, and their side walls possess pits which allow lateral movement of water between adjacent cells. Tracheids are found in all plants and are the major conduction tissues in ferns and conifers.

ROOT PRESSURE

Root pressure is the force developed by cells of the roots which forces water from the endodermal cells into the xylem vessels of the root and constantly forces water upwards through the stem to leaves. This process is active and involves utilization of many ATP molecules. Root pressure occurs as a result of endodermal cells actively secreting salts into the xylem sap from their cytoplasm, which greatly lowers the water potential in the xylem.

In some plants, root pressure maybe large enough to force liquid water through pores called hydathodes of the leaves in a process called **guttation**

The following is the evidence to show that water moves by pressure in a plant.

- When the stem of a plant is cut water continues to exude from the xylem vessels of the plant stem. The continuous exudation of water from the xylem vessels of the cut stem is due to root pressure because the leafy shoot is cut off, meaning that water not only moves upwards by transpiration pull, but also due to pressure and other forces.
- Root pressure can be measured using a mercury manometer whose diagram is shown on the right
- Though it is true that water moves from the roots through the stem to the leaves by transpiration pull, root pressure partly contributes towards the movement of water from the parenchyma cells to the xylem of the root, to the stem and eventually up to the leaves

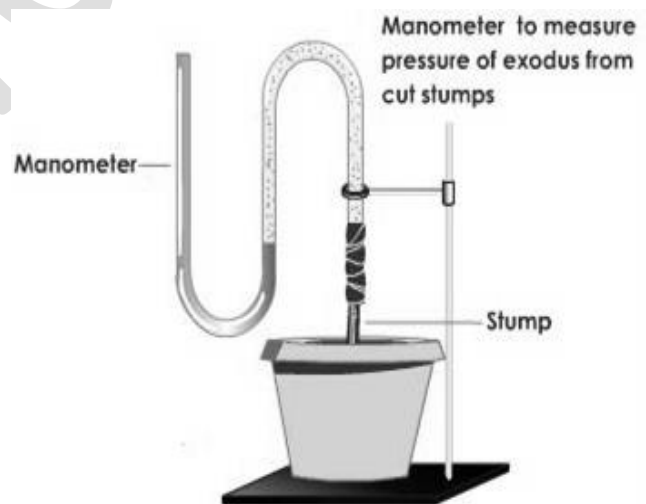

Experiment to demonstrate root pressure-B

The following is the evidence to support the mechanism of water uptake from the endodermis into the xylem vessel as an active process

- a. There are numerous starch grains in endodermal cells which could act as an energy source for active transport.
- b. Lowering the temperature reduces the rate of water exudation (given out) from the cut stem as it prevents root pressure, an active process.
- c. Treating the roots with metabolic poisons e.g. potassium cyanide also prevents water from being exuded from the cut stems. This is because the poisons kill the cells thereby preventing aerobic respiration, a source of ATP molecules.
- d. Depriving roots of oxygen prevents water from being exuded from the cut stems. This shows that water was being pushed upwards in the cut stem by root pressure, an active pressure.

THE UPTAKE OF WATER FROM THE ROOTS TO THE LEAVES

The movement of water from the roots to the leaves, via the stem, is by combination of different forces which include the following; (1) Root pressure, (2) Transpiration pull (cohesion force) & (3) Capillarity

Root pressure

This enables movement of water from the parenchyma cells of the main root into the xylem tissue due to the active pumping of cells from endodermal cells into the xylem tissue.

Root pressure also ensures upward movement of water through the xylem tissues to the leaves.

Transpiration pull (cohesive force/cohesion-tension theory of water uptake)

This offers an explanation for the continuous flow of water upwards through the xylem of the plant i.e. from the root xylem to the stem xylem and finally to the leaf xylem. Water is removed from the plant leaves by transpiration which creates a tension within the leaf xylem vessels that pulls water in the xylem tubes upwards in a single unbroken column or string held together by the cohesive forces of attraction between water molecules.

According to the cohesion-tension theory, evaporation of water from the mesophyll cells of the leaf to the sub-stomatal air chamber and eventually to the atmosphere via the stomata by transpiration, is responsible for the rising of water from the roots to the leaves. This is because the evaporated water molecules get replaced by neighbouring water molecules which in turn attract their other neighbours and this attraction continues until the root is reached.

Evaporation of water results in a reduced water potential in the cells next to the leaf xylem. Water therefore enters these mesophyll cells by osmosis from the xylem sap which has the higher water potential. Once in the mesophyll cells water moves using the three pathways namely; apoplast, Symplast and vacuolar pathways from one cell to another by osmosis across a water gradient.

When water leaves the leaf xylem to the mesophyll cells by osmosis, a tension is developed within the xylem tubes of water which is transmitted to the roots by cohesive forces of water molecules. The tension develops in the xylem vessels and builds up to a force capable of pulling the whole column of water molecules upwards by means of mass flow and water enters the base of these columns from neighbouring root cells. Because such a force is due to water loss by osmosis by transpiration, it is referred to as **transpiration pull**.

The upward movement of water through the xylem tissue from the roots to leaves is also facilitated by the cohesive forces of attraction which holds the water molecules firmly together, due to the hydrogen

bonds which exist between them. This enables water to have a high tensile strength which enables it to move upwards in a continuous stream without breaking. In addition, the upward movement of water from roots to leaves is also facilitated by adhesive forces which hold the water molecules on the xylem walls so that it continues moving upwards.

Capillarity

Since the water rises upwards through narrow leaves, it is also facilitated by capillarity through the stem. This is because the xylem vessels are too narrow and the flow of water is maintained without breaking by both the cohesive forces (between the water molecules) and adhesive forces (between the water molecules and the hydrophilic surface of the walls of the xylem).

NOTE

The continuous mass flow of water through the xylem vessels from the roots to the leaves in a stream without breaking, due to the transpiration pull is called the transpiration stream

Adhesion is the force of attraction between molecules of different substances while cohesion is the force of attraction between molecules of the same substance

The diagram below shows the upward movement of water from the soil up to the leaves.

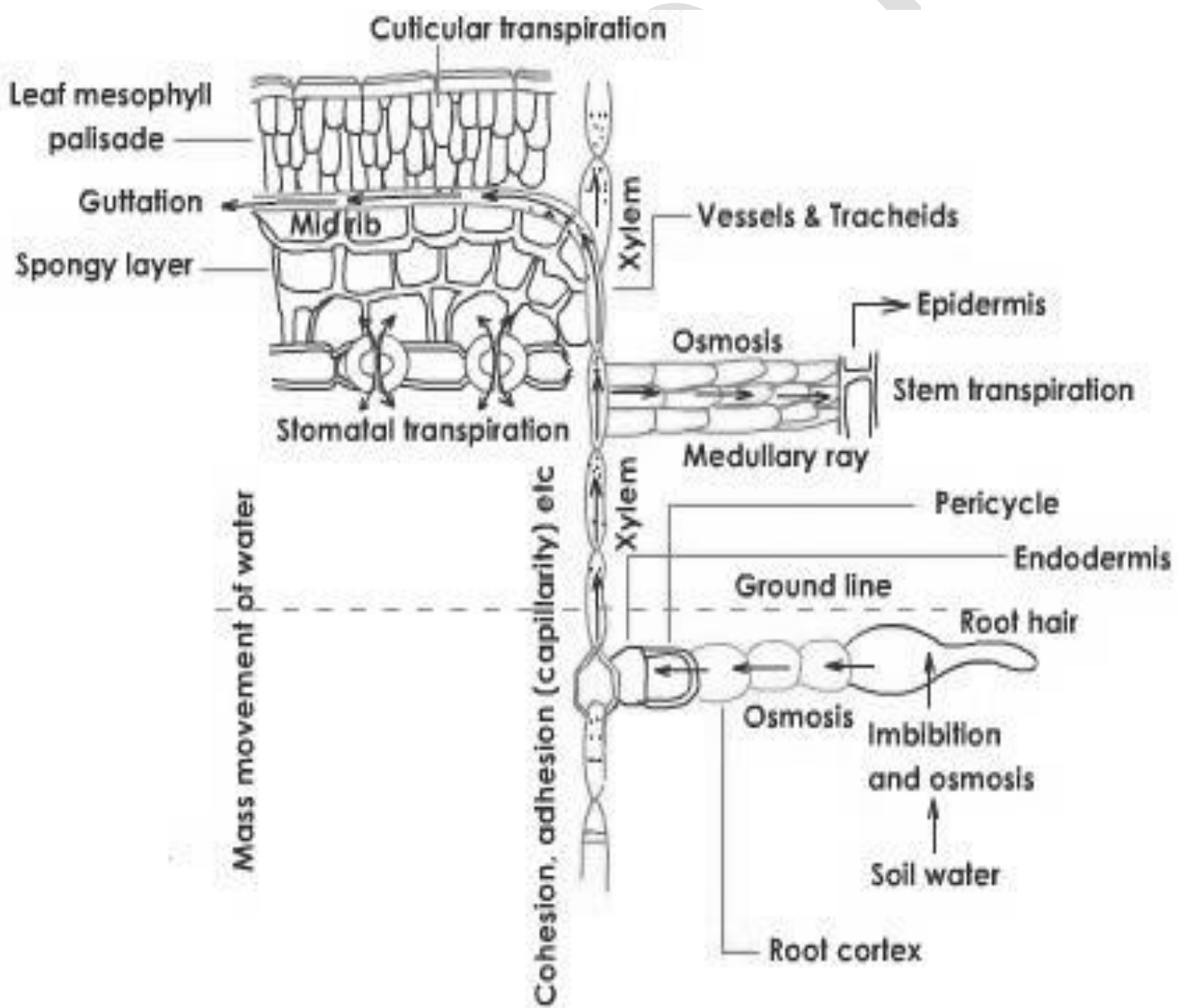

In summary**Movement of water across the leaf**

The humidity of the atmosphere is usually less than that of the sub-stomatal air-space and so, provided that the stomata are open, water diffuses out of the air-spaces into the surrounding air. Water lost from the air-spaces is replaced by water vapour evaporating from the cell wall of the surrounding **spongy mesophyll** cells. *By changing the size of the stomatal pores, plants can control water loss.* Water vapour evaporating from the cell walls of spongy cells is replaced by water reaching them from xylem by either the apoplast or symplast pathways. In case of the symplast pathway, the water movement occurs because, once the spongy mesophyll cells have lost water to the sub-stomatal air-space, they have a lower (more negative) **water potential**. Water therefore enters by **osmosis** from the adjacent cells. The loss of water from these adjacent cells cause them to have a lower water potential and so they, in turn, take in water from the neighbours by osmosis. In this way, a water potential gradient is established that pulls water from the xylem, across the leaf mesophyll, and finally out into atmosphere.

Evidence for the cohesion-tension theory

- The changes which occur in the diameter of trees according to the rate of transpiration. During the day, when transpiration is at its greatest, there is more tension (more negative pressure) in the xylem. This causes the trunk to shrink in diameter. At night, when transpiration is at its lowest, there is less tension in the xylem and so the diameter of the trunk increases
- When a xylem vessel is broken, water does not leak out which would be the case if it were under pressure, but rather air is pulled in, which is consistent with it being under tension.

UPTAKE AND TRANSLOCATION OF MINERAL IONS

Translocation is the movement of mineral salts and chemical compounds within a plant.

There are two main processes of translocation which include;

- The uptake of soluble minerals from the soil and their passage upwards from the roots to the various organs via the xylem tubes.
- The transfer of organic compounds synthesized by the leaves both upwards and downwards to various organs via the phloem tubes

Mechanism of mineral ion uptake

Minerals such as nitrates, phosphates, sulphates e.t.c. may be absorbed either actively or passively.

Active absorption of minerals**Movement of water up the stem in the xylem**

The main mechanism by which water moves up the xylem is known as the **cohesion-tension theory**. It operates as follows;

- Water evaporates from leaves as a result of transpiration
- Water molecules form **hydrogen bonds** between one another and hence tend to stick together i.e. **cohesion**
- Water forms a continuous, unbroken path across the mesophyll cells and down the xylem
- As water evaporates from mesophyll cells in the leaf into the sub-stomatal air space, more molecules of water are drawn up behind it as a result of this cohesion
- Water is hence pulled up the xylem as a result of transpiration. This is called the **transpiration pull**.
- The transpiration pull puts the xylem under tension, i.e. there is a negative pressure within the xylem.

Most minerals are absorbed from the soil solution having the less mineral concentration into the root hairs with the higher mineral concentration, selectively by using active transport which uses a lot of energy.

The rate of active absorption of minerals into the root hairs depends on the rate of root respiration. Factors such as oxygen supply and temperature will affect the rate of ion uptake. The addition of respiratory poison has shown to inhibit uptake of mineral ions.

(Soper Fig 13.19 pg 449)	(Soper Fig 13.20 pg 450)
--------------------------	--------------------------

Passive absorption

If the concentration of a mineral in a soil solution is greater than its concentration in the root hair cell, the mineral may enter the root hair cell by diffusion.

Mass flow or diffusion occurs once the minerals are absorbed by the root hairs so that they move along cell walls (apoplast pathway).

In mass flow, the mineral ions are carried along in solution by water being pulled upwards in the plant in the transpiration stream, due to the transpiration pull i.e. the mineral ions dissolve in water and move within the water columns being pulled upwards.

The mineral ions can also move from one cell of the root to another against the concentration gradient by using energy in form of ATP. This is achieved by the use of special **carrier proteins**.

Two important mineral ions in plants are nitrates and magnesium. Nitrate ions provide nitrogen is a component of:

- amino acids (make up proteins)
- nucleotides (make up DNA and RNA)
- auxins (are plant growth factors)

Magnesium is a component of chlorophyll and activator of ATPase enzyme.

The mineral ions can also move through the Symplast pathway i.e. from one cell cytoplasm to another. When the minerals reach the endodermis of the root, the Casparian strip prevents their further movement along the cell walls (apoplast pathway). Instead the mineral ions enter the cytoplasm of the cell (Symplast pathway) where they are mainly pumped by active transport into the xylem tissues and also by diffusion to the xylem tissues.

Once in the xylem, the minerals are carried up the plant by means of mass flow of the transpiration stream. From the xylem tissues, minerals reach the places where they are utilised called **sinks** by diffusion and active transport i.e. the minerals move laterally (sideways) through pits in the xylem tissue to the sinks by diffusion and active transport.

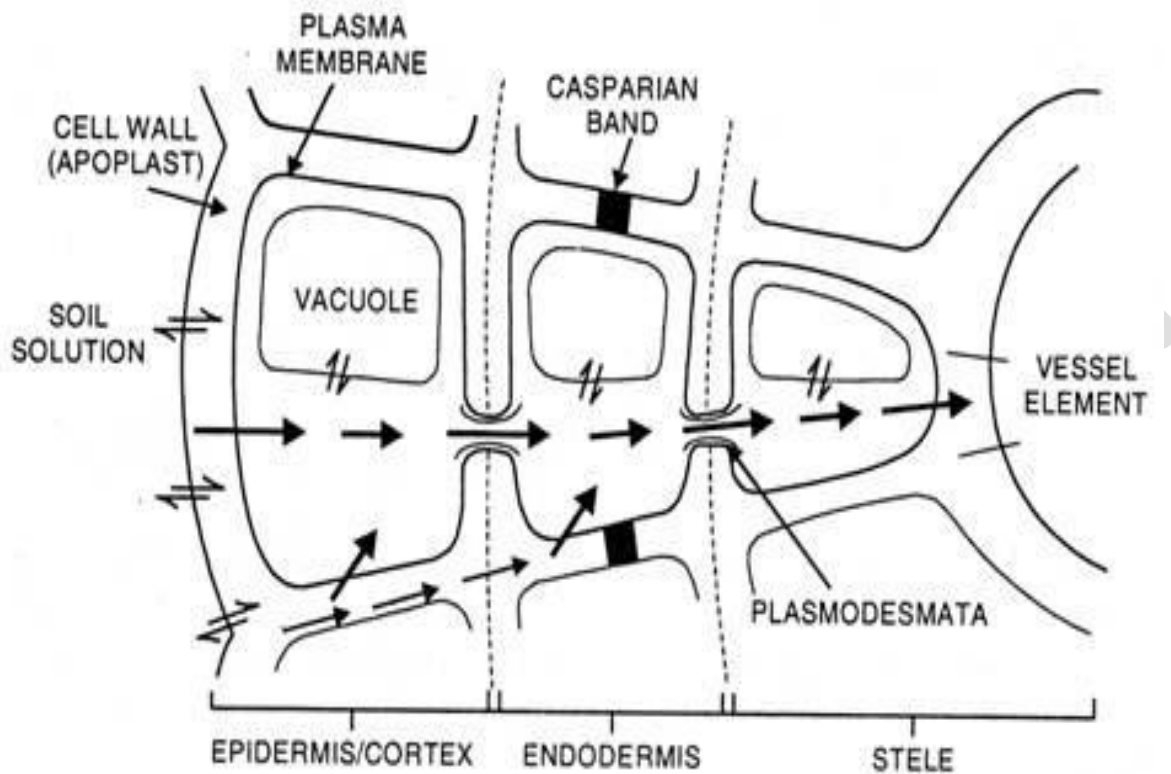

Fig. 7.5. Radial paths of movement of mineral nutrient ions in root

The following is the evidence to show that most mineral ions are absorbed actively by the root hairs

1. Increase in temperature around the plant increases the rate of mineral ion uptake from the soil as it increases respiration that can provide energy for active transport
2. Treating the root with respiratory inhibitors such as potassium cyanide prevents active mineral ion uptake leaving only absorption by diffusion. This is because the rate of mineral ion uptake greatly reduces when potassium cyanide is applied to the plant.
3. Depriving the root hairs of oxygen prevents active uptake of minerals by the roots and as a result very few ions enter the plant by diffusion.

The following is the evidence for supporting the role of the xylem in transporting minerals

1. The presence of mineral ions in the xylem sap i.e. many mineral ions have been found to be present in the xylem sap.
2. There's a similarity between the rate of mineral ion transport and the rate of transpiration i.e. if there's no transpiration, then there's no mineral ion transport and if transpiration increases, the rate of mineral ion transport also increases.

3. There's evidence that other solutes e.g. the dye, eosin, when applied to the plant roots, it is carried in the xylem vessels
4. By using radioactive tracers e.g. phosphorous-32. When a plant is grown into a culture solution containing radioactive phosphorous-32, phosphorous -32 is found to have reached all the xylem vessels but not the phloem tubes.

(The interpretation of these elements is that where lateral transfer of minerals can take place minerals pass from the xylem to the phloem and where lateral transfer is prevented, the transport of minerals takes place in the xylem)

NOTE; Some plants absorb mineral salts by using mutualistic associations between their roots and other organisms e.g. the association between the fungus and the higher plant roots called **mycorrhiza**.

TRASLOCATION OF ORGANIC MOLECULES

(Food molecules in the phloem)

The organic materials produced as a result of photosynthesis; need to be transported to other regions of the plant where they are used for growth or storage. This movement takes place in the phloem tissue particularly in the sieve tubes.

Structure of the phloem

The phloem of composed of a number of cell types:

- **Sieve tube elements** are elongated structures that are joined end to end to form long tubes. The cells are living and retain a thin layer of cytoplasm within their cell surface membrane, which lie against the cellulose cell wall. Within the cytoplasm are mitochondria and a modified form of endoplasmic reticulum. However, unlike most cells, there is no nucleus or Golgi apparatus and there are no ribosomes. These are broken down in order to make the sieve tubes more hollow and so reduce resistance to the flow of liquid within them. The end walls of the sieve tubes are perforated by large pores, to form **sieve plates**. The central space within the sieve tube is called the **lumen**.
- **Companion cells** are always associated with sieve elements and both come from the same cell division. As the sieve tube elements lack structures such as a nucleus, Golgi apparatus and ribosomes, they are unable to carry out many of the metabolic processes essential for their survival. The companion cells are the sites for these processes. Materials can easily pass through the many **plasmodesmata** that link the two types of cells. At the tips of veins in the leaf, companion cells have very folded cell walls and cell surface membranes. These special types of companion cells are called **transfer cells** and their large surface area increases the rate of transfer of sucrose into sieve tube elements. (fig 11.19 page 238 Clegg and Mackean)

How structure phloem is related to its function

1. Sieve tube elements are elongated and arranged end to end to form a continuous column
2. The nucleus and many of the organelles are located in the companion cells, leaving the lumen of the sieve tube elements more open so reducing resistance to the flow of liquid
3. Sieve plates are perforated with sieve pores, reducing resistance to liquid flow
4. Sieve tubes hold the walls of sieve tube elements together and prevent them from bursting
5. The walls contain cellulose microfibrils that run around cells, giving strength and preventing the tubes bursting under pressure
6. The walls are thin to allow easy entry of water at the source so as to build up pressure
7. Companion cells have many mitochondria to release the ATP needed for translocation of organic materials
8. Companion cells have numerous ingrowths of their cell walls to increase the surface area for active uptake of solutes .i.e. the transfer cells
9. Plasmodesmata allow easy movement of substances to and from companion cells
- 10.

Evidence to support that organic molecules of photosynthesis are transported in the phloem

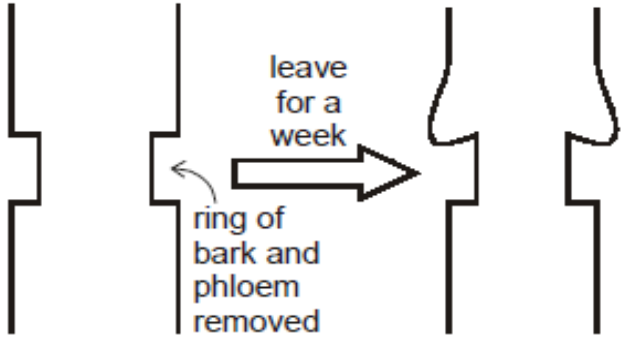
1. When the phloem is cut, the sap which exudes out of it is rich in organic food materials especially sucrose and amino acids.
 2. Removal of a complete ring of phloem around the phloem causes an accumulation of sugar around the ring, which results into the swelling of the stem above the ring. This indicates that the downward movement of the sugars has been interrupted and results into the part below the ring failing to grow and may dry out. This is called the **ringing experiment**.
- 
- The diagram illustrates the ringing experiment. It shows a cross-section of a stem with a ring of bark and phloem removed. An arrow labeled "leave for a week" points to the stem, which is shown to have swollen above the ring and dried out below it.
3. The sugar content of the phloem varies in relation to environmental conditions. When the conditions favor photosynthesis, the concentration of the sugar in the phloem increases and when they not favor photosynthesis and concentration of the sugar in the phloem reduces
 4. The use of radioactive tracers. If radioactive carbon dioxide-14 is given to plants as a photosynthetic substrate, the sugars later found in the phloem contain carbon-14. When the phloem and the xylem are separated by waxed paper, the carbon-14 is found to be almost entirely in the phloem.
 5. Aphids have needle like proboscis with which they penetrate the phloem so as to suck the sugars. If a feeding aphid is anaesthetized using carbon dioxide or any other chemical e.g. chloroform and then its mouth parts cut from the main body, some tiny tubes called the proboscis remain fixed within the phloem sieve tubes from which samples of the phloem content exudes
 6. When the contents of the phloem are analyzed, they are confirmed to be containing carbohydrates, amino acids, vitamins e.t.c. which further confirms that the phloem transports manufactured foods
 7. When small sections of the pierced stems are cut following the proboscis penetration, the tips of the proboscis are found within the phloem sieve tubes.

MECHANISM OF TRANSLOCATION IN THE PHLOEM

It was found out that organic materials do not move through the phloem sieve tubes by diffusion because the rate of flow of these materials is too fast for diffusion to be the cause. The mechanism of translocation of food in the phloem is explained by the following theories or hypothesis; **(a)** The mass flow or pressure flow hypothesis (i.e. Much's hypothesis), **(b)** Electro-osmosis & **(c)** Cytoplasmic streaming

Mass flow or pressure flow hypothesis

Mass flow is the movement of large quantities of water and solutes in the same directions.

According to this theory, photosynthesis forms soluble carbohydrates like sucrose in the leaves. The photosynthesizing cells in the leaf therefore have their water potential lowered due to the accumulation of this sucrose. Sucrose diffuses down a concentration gradient from the photosynthesizing cells into the companion cells. Hydrogen ions are actively pumped from companion cells into the apoplast (spaces within cell walls) using ATP. These hydrogen ions then flow down a concentration gradient through carrier proteins into the sieve tube elements. Sucrose molecules are transported along with the hydrogen ions, a process called co-transport. The carrier proteins are therefore also known as co-transport proteins.

Sucrose is actively pumped into the phloem sieve cells of the leaf via transfer cells. As a result, water which has been transported up to the stem xylem enters these mesophyll cells by osmosis due to the accumulation of sucrose. This causes an increase in the pressure potential of the leaf cells including the leaf sieve tube elements more than that in the cells in the sink i.e. the mesophyll cells where the sugars are manufactured are referred to as the **source** while the other parts of the plant such as the roots where food is utilized are referred to as the **sink**.

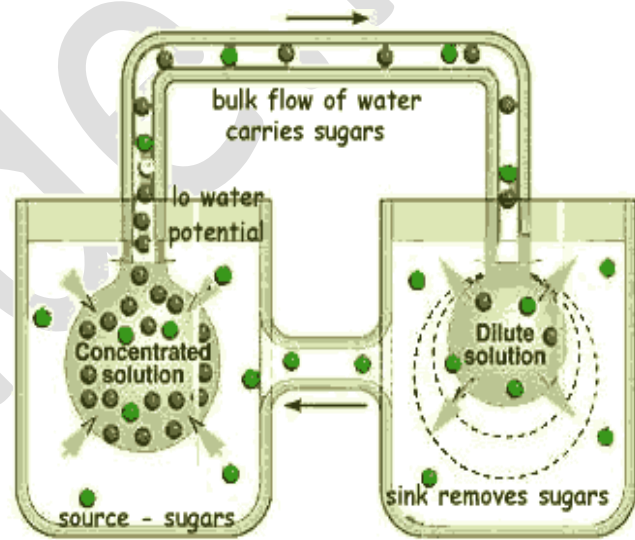

A diagram showing movement of the products of photosynthesis by mass flow

(Toole fig 22.23 pg 470, Kent fig 2 pg 286)

The food solution in the sieve tubes then moves from a region of higher pressure potential in the leaves to that of lower pressure potential in the sink such as roots following a hydrostatic pressure gradient. At the other parts of the plant which form the sink e.g. the roots, sucrose is either being utilized as a respiratory substrate or it is being converted into insoluble starch for storage, after being actively removed from the sieve tubes and channeled into the tissues where they are required. The soluble content of the sink cells therefore is low and this gives them a higher water potential and consequently lower pressure potential exists between the source (leaves) and the sink such as roots and other tissues. The sink and the source are linked by the phloem sieve tubes and as a result the solution flows from the leaves to other tissues (sinks) along the sieve tube elements

Evidence supporting the mass flow theory

1. When the phloem is cut, the sap exudes out of it by mass flow
2. There's rapid and confirmed exudation of the phloem's sap from the cut mouth parts of the aphids which shows that the content of the sieve tubes move out at high pressure.
3. Most researchers have observed mass flow in microscopic sections of the sieve tube elements.
4. There's some evidence of concentration gradient of sucrose and other materials with high concentration in the leaves and lower concentration in the roots.

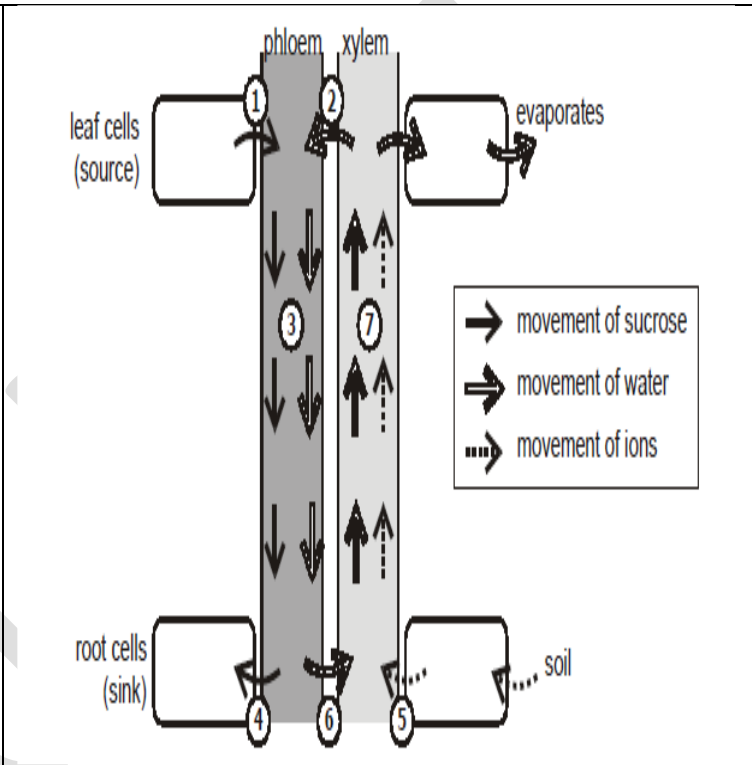

5. Any process that can reduce the rate of photosynthesis indirectly reduces the rate of translocation of food.
6. Certain viruses are removed from the phloem in the phloem translocation stream indicating that mass flow rather than diffusion, since the virus is incapable of locomotion.

Criticism of mass flow

1. By this method all organic solutes would be expected to move in the same direction and at the same speed. It was however observed that the organic solutes move in different directions and at different speeds.
2. The phloem has a relatively high rate of oxygen consumption which this theory does not explain.
3. When a metabolic poison such as potassium cyanide enters the phloem, the rate of translocation is greatly reduced, implying that translocation is not a passive process, but an active one.
4. The mass flow hypothesis does not mention any translocation of solutes with influence of transfer cells and Indole Acetic Acid (IAA) hormone that loads the sugars or solutes into the sieve tubes and also unload it into the cells of the sink.

5. The sieve plates offer a resistance which is greater than what could be overcome by the pressure potential of the phloem sap. This implies that the pressure would sweep away the sieve plates during this transport.
6. Higher pressure potential is required to squeeze the sap through the partially blocked pores in the sieve plates than the pressure which has been found in the sieve tubes

NOTE: the mass flow theory is considered to be the most probable theory in conjunction with electro-osmosis

Electro-Osmosis

This is the passage of water across a charged membrane.

This membrane is charged because positively charged ions e.g. K^+ , actively pumped by the companion cells across the sieve plate into the sieve tube element using energy from ATP of the companion cells. Potassium ions accumulate on the upper side of the sieve plate thereby making it positively charged. Negatively charged ions accumulate on the lower sides of the sieve plate thereby making it negatively charged.

The positive potential above the sieve plate is further increased by hydrogen ions, actively pumped from the wall to the upper sieve tube element into its cytoplasm.

Organic solutes such as sucrose are transported across the sieve plates due to an electrical potential difference between the upper and the lower side of the sieve plate whereby the lower side is more negative than the upper side i.e. solutes move from the upper sieve tube element which is positively charged to the lower sieve element which is negatively charged.

The electrical potential difference is maintained across the plate by active pumping of positive ions, mainly potassium ions, in an upward direction. The energy used is produced by the companion cells. The movement of K^+ ions through the pores of the sieve plates rapidly draws molecules of water and dissolved solutes through the sieve pores, to enter the lower cell.

(Clegg fig 16.39b pg 341)

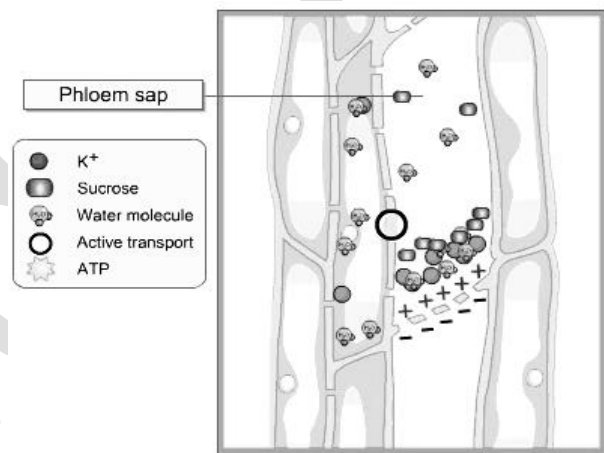

Evidence to support the electro-osmosis theory

1. K^+ ions stimulate the loading of the phloem in the leaves with sugars during photosynthesis.
2. Numerous mitochondria produce a lot of energy for translocation, an indicator that translocation is an active process. If however, the phloem tissues are treated with a metabolic poison, the rate of translocation reduces.

Cytoplasmic streaming theory

This suggests that the protoplasm circulates using energy from sieve tubes elements or companion cells through the sieve tube elements from cell to cell via the sieve pores of the sieve plates.

As the protoplasm circulates, it carries the whole range of the transported organic materials with it. The solutes are moved in both directions along the trans-cellular strands by peristaltic waves of contraction, such that they move from one sieve tube element to another using energy in from of

ATP. The proteins in the strands contract in a wave form, pushing the solutes from one sieve tube element to another, using energy in form of ATP.

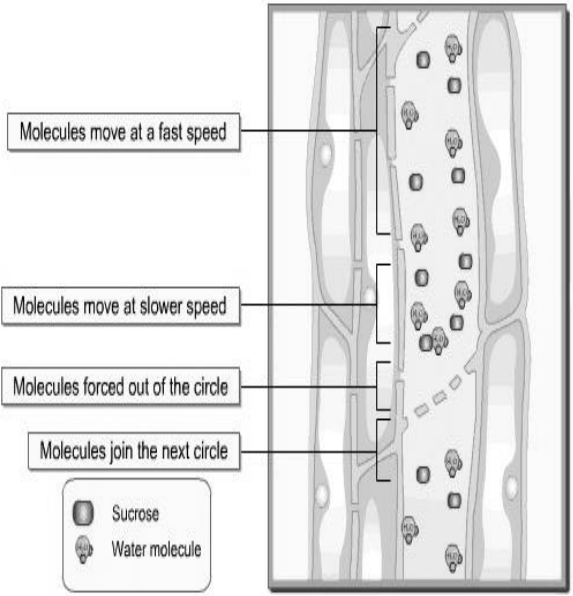
<p>Evidence supporting the cytoplasmic streaming theory</p> <ol style="list-style-type: none"> 1. It has been found that the solute materials move in both directions in the phloem tissue 2. The theory explains the existence of the trans-cellular strands in the phloem tissue as well as many mitochondria in the companion cells 3. Presence of a sieve plate where a potential difference can be developed across the plate 4. Criticism of the Cytoplasmic Streaming Theory 5. Cytoplasmic streaming has not been reported in mature sieve tube elements but only in young sieve tubes. 6. The rate at which the protoplasm streams is far slower than the rate of translocation 	<p><i>Diagram showing Cytoplasmic streaming (Kent fig 3 pg 287)</i></p> 
---	--

SAMPLE QUESTIONS

1. Distinguish between the terms **immunity** and **autoimmunity** (02 marks)
 (b) Suggest **three** key roles played by the body's immune system (03 marks)
 (c) State **three** ways body openings are protected from entry of pathogens (03 marks)
 (d) State **two** human diseases resulting from autoimmune disorders (02 marks).
2. The figure shows the changes in the cardiac output of two individual Mammals and A and B of different sizes, determined from 6:00a.m up to 4:00p.m in the evening when the mammals were given a hot drink.

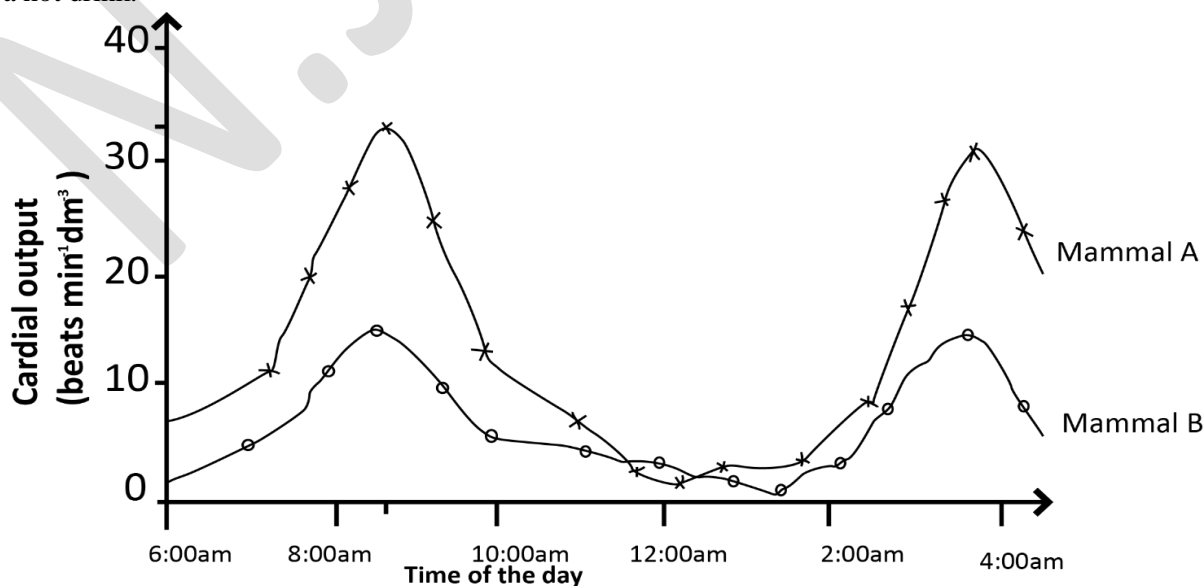

- i. Compare the cardiac output of both mammals. (04marks)

- ii. Explain the effect of day time on the cardiac output of both mammals. (08marks)
- iii. Comment on the difference in the cardiac output both mammals. (04marks)
- iv. Suggest factors that are likely to affect the cardiac output of a mammal. (03marks)
- b) The table below shows the volume of blood flowing from the left vertical side of the heart of various parts of the body in one minute at rest and during a heavy exercise.

Organ	Volume of blood/cm ³	
	Rest	Exercise
Brain	750	750
Heart Muscle	250	750
Skeletal muscle	1,200	1,250
Skin	500	1,900
Kidney	1,100	600
Other organs	2,000	1,000

- i. Calculate the percentage increase in blood flow from rest to exercise in skeletal muscle. (03 mark)
- ii. Give three ways in which the increase in b(i) is achieved. (03 marks)
- iii. Explain the changes in volume of blood flow rest to exercise to various parts of the body. (11 marks)
- iv. Suggest with reasons the likely changes in composition of blood as it flows through the kidney. (04)
3. In an investigation pea plants were dug up from the field and washed thoroughly. The nodules were removed surface sterilized and transferred aseptically to a sterile liquid culture medium. After two weeks incubation, small samples of culture media were removed and added to trays each containing a batch of pea plants growing in an inert medium. Each batch was watered regularly with a nutrient solution containing a particular concentration of sodium nitrate for four weeks, at the end of four weeks the mean number of root nodules and biomass were obtained from the investigation are shown in the table below.

Nitrate concentration of nutrient solution (arbitrary units)	Mean number of nodules per plant	Biomass of pea plants /gm ⁻²
0	82	140
1	70	200
2	68	230
3	40	350
3.5	20	400
4	10	460
5	0	440
5.5	0	400
6	0	350

- (f) Represent the results of the table above graphically (08 marks)
- (g) Explain the changes in mean number of nodules per plant and changes in the biomass of pea plants with increasing nitrate concentration of nutrient solution (20 marks)
- (h) How was accuracy of results to be obtained ensured throughout the experiment (05 marks)
- (i) (i) on the graph draw a graph to represent the plot for biomass you would expect if the experiment was repeated and in this case the sample culture medium was not added to the trays containing pea plants (02 marks)
- (ii) Suggest reason(s) for the appearance of the graph drawn in d (i) above (03 marks)
- (j) How can the information from the investigation be beneficial in crop production? (02 marks)

4. In an experiment to investigate the effect of light intensity on the rate of transpiration and stomatal opening a leafy herbaceous plant was used. A potometer with the stem of a herbaceous plant was placed in an open grassland, the following results were obtained.

Light intensity in μm	Number of open stomata per branch	Rate of transpiration in $\text{mgm}^{-2}\text{h}^{-1}$
10	30	28
30	50	36
40	62	41
60	90	50
80	51	33
90	28	20
100	0	7

- (a) Represent the above results graphically on the same axes (09 marks)
- (b) Compare the effect of light intensity on the rate of transpiration and the number of open stomata (06 marks)
- (c) Explain the effect of light intensity on the number of open stomata (14 marks)
- (d) (i) State the relationship between the number of open stomata and the rate of transpiration (02 marks)
- (ii) Explain the relationship stated in (c) (i) above (06 marks)
- (e) Explain the results obtained at $100\mu\text{m}$ of light intensity (03 marks)
5. (a) The human immune deficiency Virus (HIV) is a retrovirus that suppresses the immune system resulting into Acquired Immune Deficiency Syndrome (AIDS). **Figure 1** below shows the development of an infection with HIV over a period of 10 years and the changes in the number of T-lymphocytes that activate other cells of the immune system. Use this information and **figure 1** to answer the questions that follows

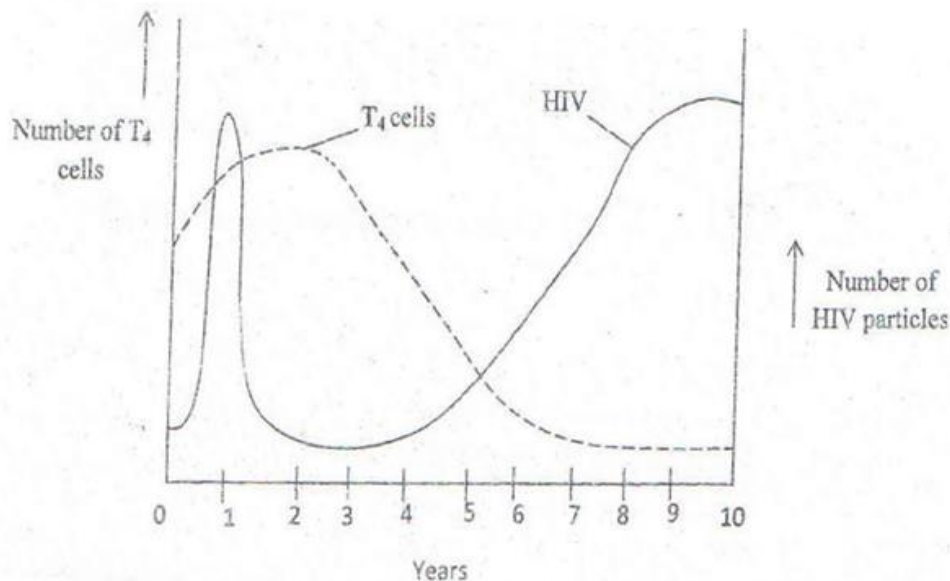

- (i) Describe the Variation in the number of HIV particles and T-lymphocytes for the period of ten (10) years. (05 marks)
- (ii) Explain the relationship between number of HIV particles and T-lymphocytes for the period shown. (09 marks)
- (iii) From the figure; what evidence shows that HIV suppresses the immune system. (03 marks)
- (iv) Predict with a reason what would happen if the development of an infection continued for another five years. (03 marks)
- (v) Suggest a reason why it has taken long to obtain a vaccine for HIV. (04 marks)

(b) **Figure 2** below shows the comparison of antibodies produced to the same antigen during primary and secondary response.

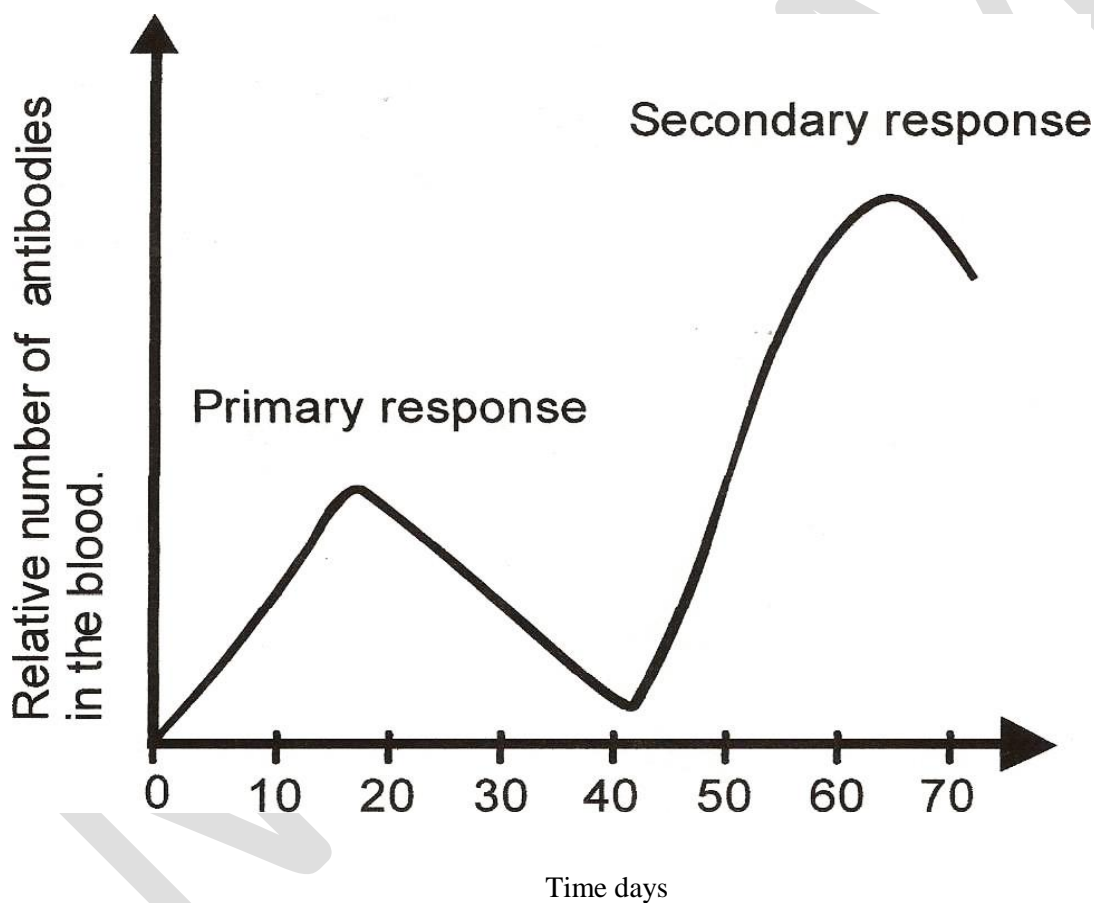

- (i) Compare the primary and secondary response (03 marks)
- (ii) Explain how each response is being stimulated. (08 marks)
- (iii) From figure 2, what is the significance of a secondary response in the immune system of an individual. (03 marks)
- (iv) Suggest other ways in which the body defends its self against diseases causing organisms. (02 marks)

6. Differentiate between natural active immunity and artificial active immunity. (02 mark)
 (b) What are the different ways in which the mammalian body naturally defends itself against pathogens? [12 marks]
 (c) Explain how artificial active immunity occurs. [06 marks]

7. An experiment was carried out to investigate the rate of water loss by three groups of leafy plants under different conditions. Twelve leafy plants of approximately the same age, leaf surface area and of the same species were used in the experiment. Four plants were placed in each group and treated simultaneously as follows:

Group 1: Plants completely covered with transparent polythene bags.

Group 2: Plants fanned with an electric fan.

Group 3: Plants placed in still air in the open

The figure below shows the results of the experiments and the mean volume in cubic centimetres of water lost through evaporation over the leaf surfaces of groups of plants recorded. Each group of plants is represented as A, B and C in the figure 1 below

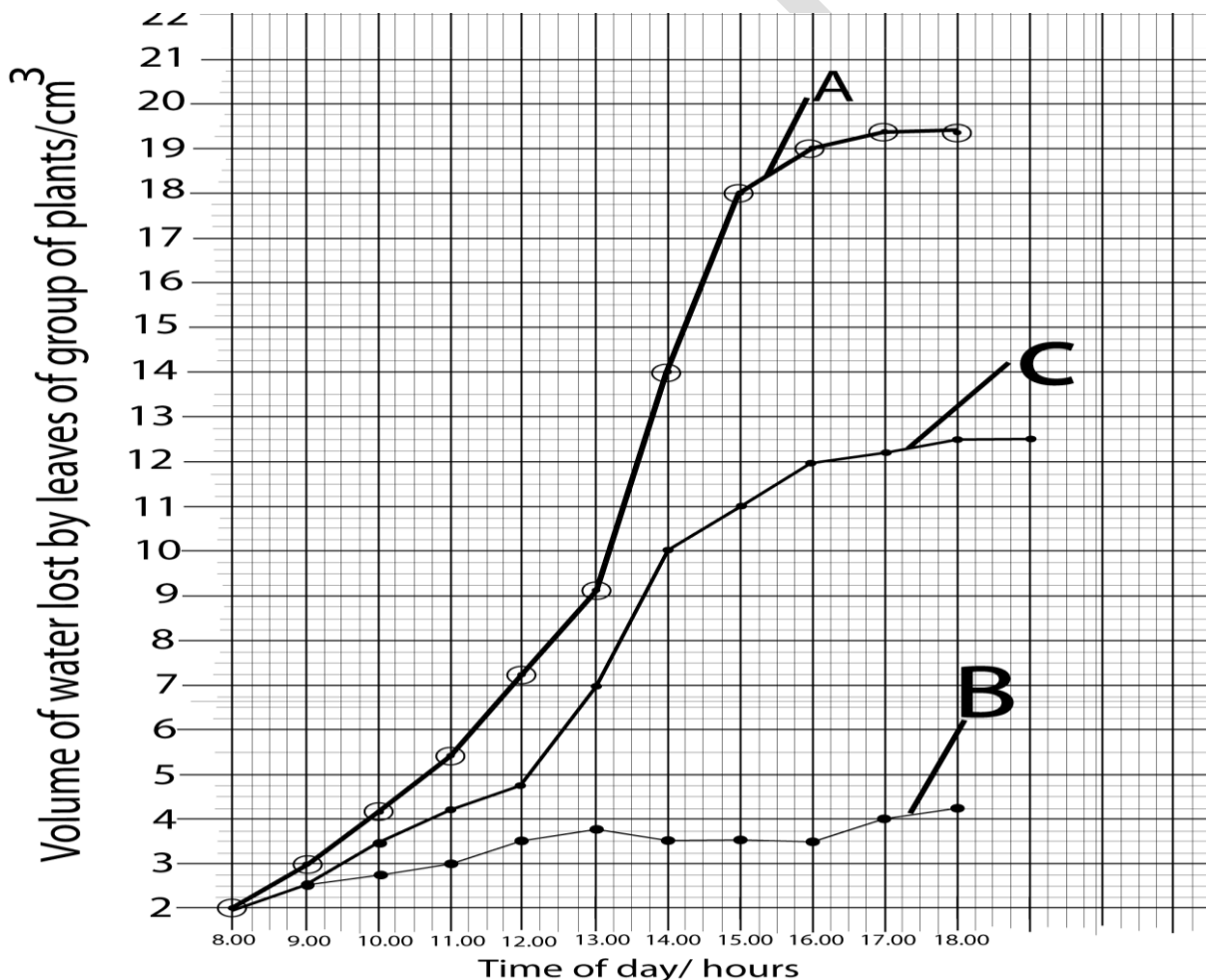

- (a) Compare the volume of water lost by the leaves of different groups of plants shown in figure 1 above. (12 m)
 (b) (i) From the curves drawn, identify the experimental conditions to which each group of plants A, B and C were placed. (03 marks)

- (ii) With respect to group of plants **A** and **B**, suggest reasons for the observed difference in the two curves drawn. (07 marks)
- (c) Why were the plants of the same age, leaf surface area and same species used in the experiment? (05 marks) Suggest
 - (i) a hypothesis which this experiment was designed to test. (01 mark)
 - (ii) the name of the apparatus commonly used in this type of experiment. (01 mark)
- (d) (i) Calculate the rate of water loss over the leaf surfaces by evaporation in group **C** between the time of the day 12:00 – 14:00 hours and 16:00 – 18 hour (03 marks)
- (ii) Explain the difference in the rate of water loss by the same group of plants at various times of the day. (08 marks)

8. The figure below shows the amount of oxygen carried by haemoglobin in three different mammals during the course of the day.

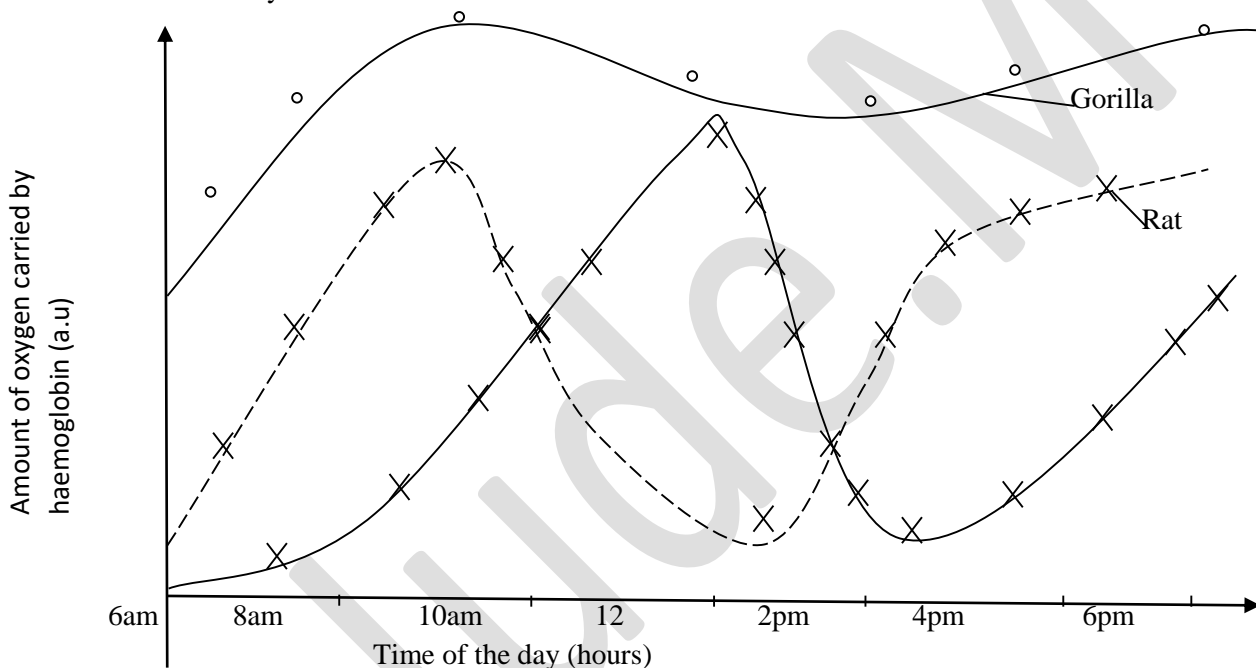

- (i) Outline the differences in the amount of oxygen carried by haemoglobin of a rat with that of a human. (04marks)
- (ii) Explain the trend of oxygen carried by haemoglobin for the;
 - Gorilla (05 marks)
 - Human (06 marks)
 - Rat (06 marks)

b) Table 1 below shows the data obtained during an investigation on the effect of altitude on the amount of oxygen carried by haemoglobin and the rate of oxygen delivery to body tissues, for a person with sickle cell trait.

Altitude (metres)	Amount of oxygen carried by haemoglobin/cm ³	Rate of oxygen delivery to blood tissues (cm ³ /minute)

0	85	20
100	80	5
200	73	11
300	48	20
400	32	45
500	20	60
600	15	75
700	13	85
800	11	88
900	8	90
1000	7	93

- (i) Represent the above information on the graph paper. (06 marks)
- (ii) Explain the relationship between altitude and the;
- the rate of oxygen delivery to body tissues. (05 marks)
 - amount of oxygen carried by haemoglobin (06 marks)
- c) What possible conclusion can be made from figure 1 and the graph plotted? (02 marks)
9. (a) What is meant by the term **human specific defence system**? (02 marks)
- (b) Describe the role played by the thymus glands in the human specific defence system (12 m)
- (c) Of what importance is memory and diversity to a defence system? (06 marks)
10. Differentiate between Natural active immunity and Artificial active immunity (02 marks)
- b) State the different ways in which the mammalian body naturally prevents pathogens from accessing its internal environment (11 marks)
- c) What is the significance of the high body temperature experienced when the mammalian body is attacked by *Plasmodium Spp*? (07 marks)
- a) What is meant by the term chloride shift? (03 marks)
11. Account for the relative position of the oxygen dissociation curves of the human and rat haemoglobin
- (b) Explain the rapid dissociation of oxyhaemoglobin of a rat during a vigorous activity (07 marks)
- (c) Describe the events which occur during the heart beat (16 marks)
- (d) Outline the features which ensure efficient flow of blood within the mammalian body (04 marks)
12. What are the essential features of the immune system in mammals?
- b) (i) Give an account of the ABO blood group system in humans, and explain how certain ABO group donations cause agglutinations with the recipients, while others do not.
- (ii) Besides blood, other tissues can be transplanted from one individual to another. Mention problems associated with them, and steps taken to minimize the transplant failure

13. (a) What is the physiological significance of the Bohr effect in animals? (08 marks)
 (b) Discuss the factors that may alter the rate of heart beat in mammals (12 marks)

14. Figure 3 shows the union of oxygen and haemoglobin in three different physiological conditions

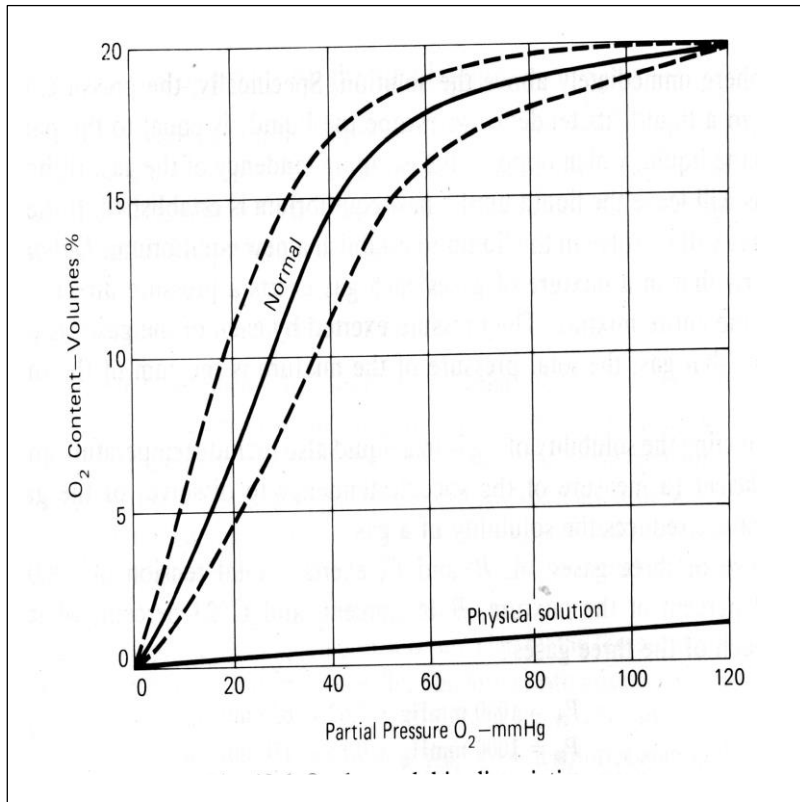

The straight line near the bottom of the graph shows the uptake of oxygen by a solution when hemoglobin is not present while the dotted curves on either side of the solid curve shows the formation of oxyhaemoglobin under two different levels of carbon dioxide

- (a) Label the curves of blood in
 (i) veins and muscles and
 (ii) arteries and lungs (02 marks).
- (b) Explain the importance of the positions suggested above in the physiology of the animal (04 marks).
 (c) Explain the difference in the variation of the oxygen content of normal and physiological solutions (03 marks)

15. Give an account of the structures involved in the translocation of organic solutes between the different parts of a flowering plant.

- (b) Briefly describe how dissolved blood carbon dioxide is expelled in gaseous form by the lungs.

16. In fish, oxygen is transported in the blood in the form of oxyhaemoglobin. The table below shows the percentage saturation of blood with oxygen of a teleost (bony) fish after equilibrating with oxygen of different partial pressures. The experiment was carried out at two different partial pressures of carbon dioxide.

Partial pressure of oxygen in Pa	Percentage saturation of blood with oxygen	
	Partial pressure of carbon dioxide at 500 Pa	Partial pressure of carbon dioxide at 2600 Pa
500	30	5
1000	70	13
2000	90	24
3000	96	33
4000	98	41
5000	99	48
7000	100	60
9000	100	69
11000	100	76
13000	100	81

- Present the data in a suitable graphical form.
- Calculate the difference of percentage saturation of blood with oxygen at the two different partial pressures of carbon dioxide at oxygen partial pressures of 500 Pa.
- With reference to the graph, describe the effects of different partial pressure of carbon dioxide on the percentage saturation of blood with oxygen.
- Explain how changes in oxygen content of blood at different partial pressure of carbon dioxide are important in the release of oxygen to the tissues of fish.
- What information do such experiments give about the environmental conditions in which fish would maintain a high level of growth as required in commercial fish farming?
- Explain how the properties of haemoglobin molecule are affected by changes in the oxygen and carbon dioxide partial pressures.

17. The linear velocity of flow of sap through the xylem of a tree was measured in mh^{-1} in the trunk and in one of the small branches at the top of the tree. Measurements were taken at two-hourly intervals during a hot day. The results are shown in the below.

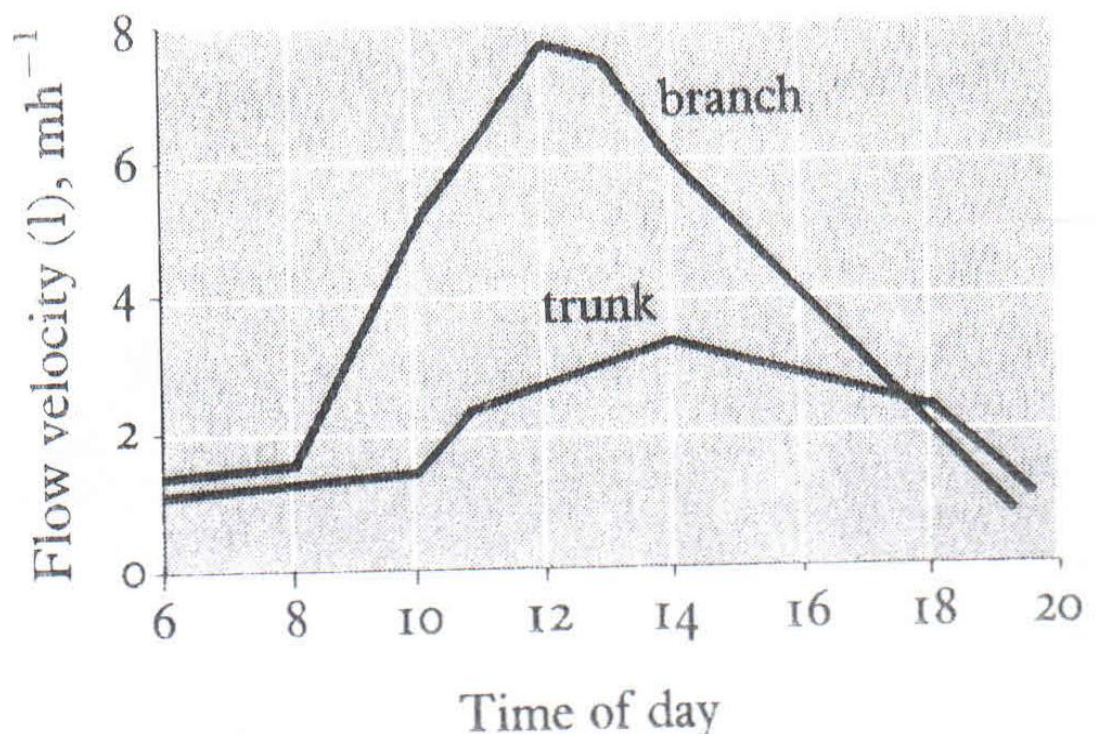

(07 marks)

- (ii) Explain the difference obtained in the flow velocity for the trunk and branch at 14:00 hours. (04 marks)
- (iii) Briefly explain the difference would you expect in the circumference of the trunk measured at 14:00 hour when compared with that measures at 18:00 hrs?(04 marks)
- (iv) Explain how the results would change if the experiment was carried out on a cold day (03 days)

(b) Table 1 shows the relative number of stomata and relative rate of transpiration, in your difference plant species.

Table 1

Plant Species	A	B	C	D
Relative number of stomata mm^{-2} of leaf (upper : lower surface)	5:30	0.80	10:15	0.50
Relative transpiration rate (upper: lower surface)	10:12	0:4	15:30	20:50

- (i) Comment on the distribution of stomata in the four species (06 marks)
 - (ii) Explain the relationship between the distribution of stomata and the rate of transpiration in;
 - Species B. (04 marks)
 - Species D. (03 marks)
 - (iii) From the data, what conclusions can be drawn about the difference between the upper leaf surface of species B and D.? (03 marks)
- (c)
- (i) Describe how cohesive and adhesive forces ensure a continuous water column up the xylem vessels. (03 marks)
 - (ii) How does bulk flow in the xylem differ from diffusion (03 marks)

18. Figure 1 below shows the diurnal variation in the sucrose content of leaves and the phloem in stems.

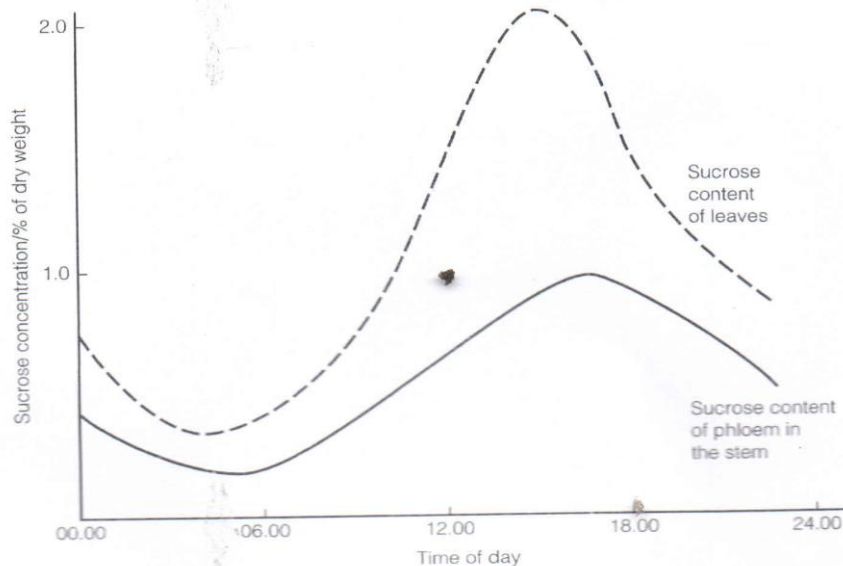

- (i) Compare the trend in sucrose concentration in the leaves and the stem. (08 marks)
- (ii) Account for changes in sucrose concentration between 00.00hrs and 16:00 hr (10 marks)
- (iii) Describe the relationship between sucrose content of leaves and sucrose content of phloem in the stem. (03 marks)
- (iv) Explain the relationship described in (a) (iii) above. (06 marks)

- (b) In an experiment, a scientist used very sensitive recording equipment to observe the diameter of certain very large trunks.

Figure 2 shows the results obtained when changes the trunk diameter of one of the trees was measured for a period of about four days

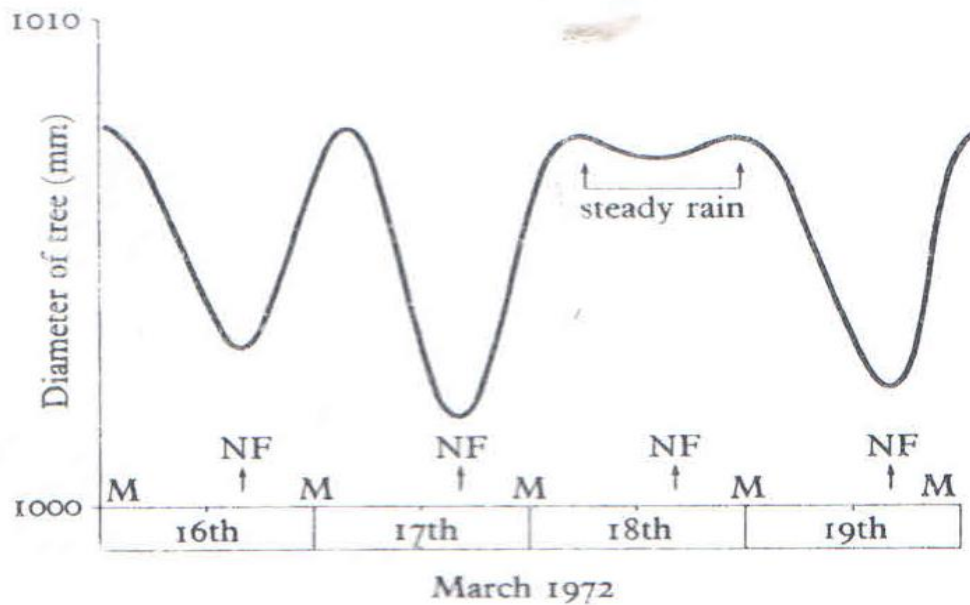

- (i) Explain the effect of time of day on the diameter of the trunk between 16th and 17th of March. (08 days)
- (ii) Explain the effect of steady rain on the diameter of tree as seen on the 18th day. (05 days)

19. The figure below shows changes in the blood pressure in the aorta and the left ventricle during two complete cardiac cycles.

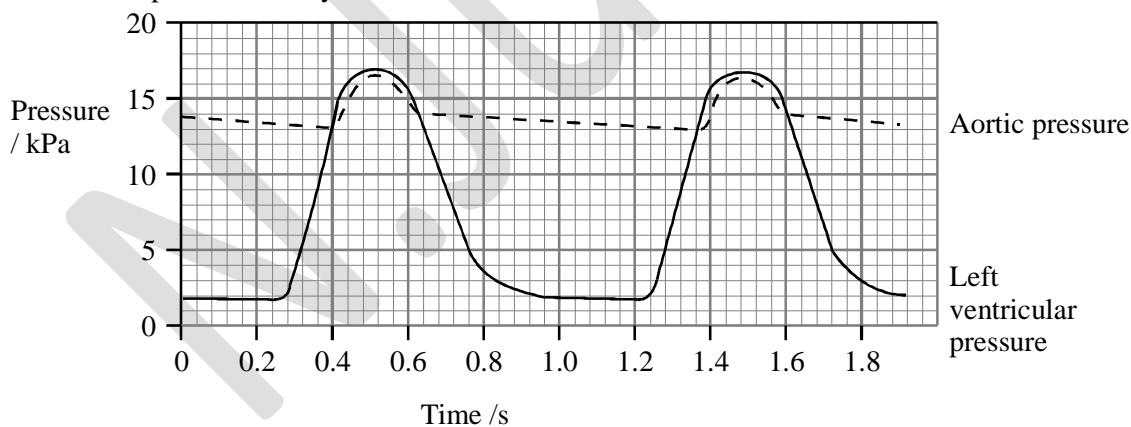

- (a) On the graph, draw an arrow to show when the left atrioventricular (mitral) valve closes. (01 mark)
- (b) Use the information in the graph to calculate the heart rate. Show your working. (02 marks)
- (c) During the cardiac cycle, the pressure in the left ventricle falls to a much lower level than in the aorta. Suggest an explanation for this difference. (03 marks)
- (d) During the cardiac cycle, the pressure in the right ventricle rises to a maximum of about 3.3 KPa. Suggest reasons for the difference between this pressure and the maximum pressure in the left ventricle. (03 marks)

20. Blood that is fully saturated with oxygen carries 105cm^3 of oxygen in 1 dm^3 (liter) of blood
 (a) Calculate the volume of oxygen released from 1 dm^3 of blood when blood that has become 90% saturated at 38°C reaches a part of the body where the partial pressure is 18% (03 marks)
 The figure below shows the oxygen dissociation curve of hemoglobin from a mammal at 38°C .

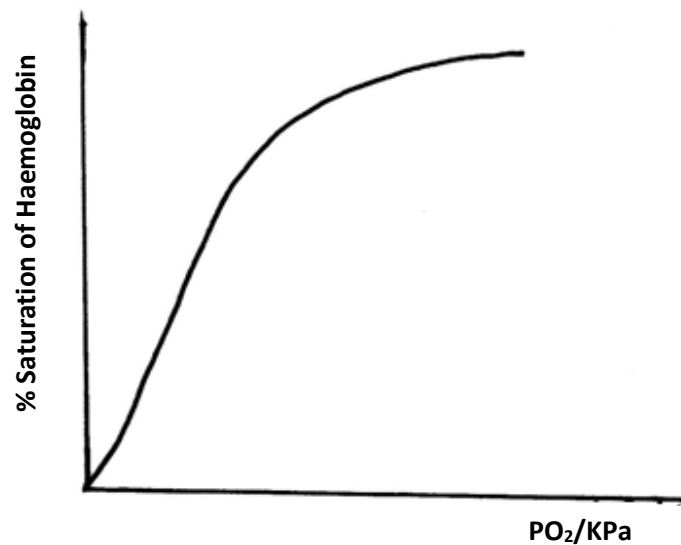

- (b) Draw the curve of hemoglobin when the body temperature is raised to 43°C (01 mark)
 (c) Name one change in the conditions in the tissues which has the same effect on the oxygen dissociation curve as change in temperature (01 mark)
 (d) Explain the effect of increased body temperature on the oxygen dissociation curve for hemoglobin in mammals(03 marks)
 (e) State how this effect of temperature on the oxygen dissociation curve of hemoglobin might be advantageous to the mammal (03 marks)

21. The table below shows the results of an experiment on the rate of absorption of sugars by a mammalian intestine. Study it carefully and answer the questions that follow.

Sugar		Relative rates of absorption taking normal glucose uptake as 100	
		By living intestine	By intestine poisoned with cyanide
Hexose sugars	Glucose	100	30
	Galactose	106	35
Pentose sugars	Xylose	32	32
	Arabinose	30	31

- (f) Suggest a reason for the difference between the rates of absorption of hexose and pentose sugars in the living intestines (03 marks)
 (g) Mention the mechanism by which hexose sugars are absorbed by living intestines ($0\frac{1}{2}$ mark)
 (h) What is the advantage to the individual of having hexose sugars absorbed in the way mentioned above?
 (i) What could be the effect of cyanide on the mechanism of hexose absorption? (02 marks)
 (j) In an intact mammal, absorption of fatty acids is drastically curtailed by any clinical condition which leads to a reduction in bile salt excretion or release. Explain why this is so. (03 marks)

22. (a) What is meant by the term **Bohr's effect**? (02 marks)

- (b) Briefly explain the following observations;
 The oxygen dissociation curve of,

- i. man shifts to the right during exercise (03 marks)
 - ii. the elephant is on the left of the oxygen dissociation curve of a mouse? (03 marks)
 - iii. the lungworm is on the left of that of man? (03 marks)
- c) Explain three factors that influence the affinity of haemoglobin for oxygen (06 marks)

23. The table below shows the difference in percentage saturation in blood with oxygen at varying partial pressure of oxygen between a pregnant woman and that of the fetus developing in her uterus.

Partial pressure of oxygen /mmHg	Percentage saturation of blood with oxygen	
	mother	Fetus
1.3	8	10
2.7	20	30
3.9	40	60
5.3	65	77
6.6	77	85
8.0	84	90
9.3	90	92
10.6	92	92

- i) Plot the results in a suitable graphical form. (08 marks)
 - ii) Compare the percentage saturation of blood for the mother and that of the fetus.(04 marks)
 - iii) State and explain the shape of the curve for the mother. (07 marks)
 - iv) Explain the physiological significance of the position of the fetal curve (05 marks)
- b) Explain what is meant by:
- i) Bohr’s effect
 - ii) Loading tension
 - iii) Un loading tension
24. What fundamental physical constraints necessitate a circulatory system in large organisms? (02 marks)
- b) State **one** advantage and **one** disadvantage of a closed circulatory systems (02 marks)
 - c) State **two** physiological advantages of separate pulmonary and systemic circuits in a mammalian circulatory system (02 marks)
 - d) Figure 6 shows the interrelationship of blood flow velocity, cross sectional area of

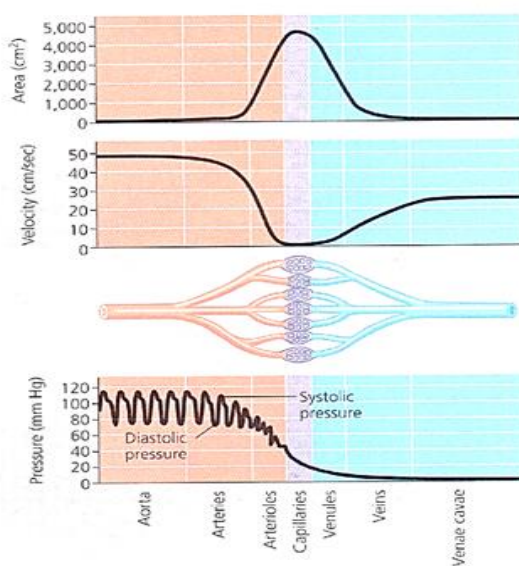

Explain the relationship between **area** and **velocity** in the arteries

REFERENCES

8. D.T.Taylor, N.P.O. Green, G.W. Stout and **R. Soper**. Biological Science, 3rd edition, Cambridge University Press
9. M.B.V.**Roberts**, Biology a Functional approach, 4th edition, Nelson
10. C.J.Clegg with D.G.Mackean, ADVANCED BIOLOGY PRICIPLES AND APPLICATIONS, 2nd EDITION, HODDER EDUCATION
11. Glenn and Susan **Toole**, NEW UNDERSTANDING BIOLOGY for advanced level, 2nd edition, Nelson thornes
12. Michael **Kent**, Advanced BIOLOGY, OXFORD UNIVERSITY PRESS
13. Michael Roberts, Michael Reiss and Grace **Monger**, ADVANCED BIOLOGY
14. J.SIMPKINS & J.I.WILLIAMS. ADVANCED BIOLOGY

TOPIC 8: EVOLUTION

SYLLABUS EXTRACT

Specific objectives: The learner should be able to;	Content
1.1 Origin of life	•
• Explain the theories related on the origin of life	• Theories of the origin of life: special creation spontaneous generation, biochemical evolution
1.2 Mechanism of evolution	•
• Discuss Lamarck's theory of evolution • Explain Darwin's theory of natural selection • Explain the importance of variation in evolution. • Discuss Neo-Darwinism • Explain causes of present day evolution	• Lamarck's theory of evolution of acquired character through use and disuse. • Darwin's theory of natural selection: observations and deductions. • Importance of variation in evolution. • Neo-Darwinism (present day theory of evolution) • Causes of present day evolution: competition changes in the environment, sexual reproduction, mutations, gene recombination, industrialization, effects of drug/chemical resistance, artificial selection, polyploidy.
1.3 Evidence of evolution	•
• Discuss evidence of evolution • Explain the emergence of variations among organisms	• Evolution evidence based on : fossilization, comparative study of anatomy, embryology, cytology, biochemistry, taxonomy, geographical distribution, vestigial structures, analogous structures, homologous structure. • Emergence of variations among organisms.
1.4 Selection and speciation	
1 Explain natural selection and artificial selection 2 Define speciation 3 Describe allopatric speciation and sympatric speciation. 4 State the roles of natural selection and artificial selection in speciation. 5 Describe mechanisms related to speciation of organisms 6 Explain extinction	1 Natural selection 2 Definition of speciation 3 Allopatric speciation and sympatric speciation. 4 Role of natural selection and artificial selection in speciation. 5 Mechanisms related to speciation : continental drift, migration, adaptive radiation, divergent and convergent evolution, isolation i.e. Ecological reproductive and genetic. 6 Extinction: meaning causes and effects.
1.5 Population genetics	
1 Explain gene frequency in the gene pool of a population 2 State the Hardy Weinberg equilibrium 3 Explain how different factors affect the gene frequency in a population	1 Gene frequency in the gene pool of a population. 2 Hardy-Weinberg equilibrium: natural selection, no random mating mutation, migration small population size.

EVOLUTION

This is a gradual process by which new species are formed from pre-existing less differentiated species over a period of time due to changes in the prevailing environmental conditions. It also be defined as change, over a long time, in the genetic composition of a population which leads to the emergence of new species.

During this process organisms undergo various structural and physiological modifications in order to fit in the prevailing environmental conditions which are genetically transferred to subsequent generations thereby forming new species. This has led to diversification of life forms since they are varying environmental conditions in which organisms have to adopt.

THEORIES FOR THE ORIGIN OF LIFE

1. SPECIAL CREATION

It is believed that living organisms were created by the almighty God in the very forms they exist today. This implies that there has not been any evolution or change of life form.

2. SPONTANEOUS GENERATION

This theory suggests that living organisms emerged from non-living forms spontaneously (suddenly).

- i. This is supported by the fact that dead decomposing materials may lead to formation of maggots.
- ii. A newly constructed pond of water may eventually contain certain organisms such as fish
- iii. Dirt may lead to the emergence of lice in the hair.

However, this theory was rejected by scientists who believe that living organism must originate from the already existing living organisms of their kind (Pre-existing life).

3. ORGANIC EVOLUTION THEORY

This theory suggests that life did not start from planet earth but instead from other planets. According to this theory, life came into planet earth in form of meteorites (fragments) from other planets which contained organic materials. These fragments later joined to form living organisms. This theory therefore presupposes that a living organism must give rise to new individuals of its own origin.

4. THE SYNTHETIC THEORY

It suggests that inorganic elements such as oxygen, ammonia, water, carbon dioxide e.t.c. Inorganic compounds joined together to form organic material from which the living organisms emerged. It was believed that forces from the earth crust facilitated the joining together of these materials to form living organisms. This is supported by the fact that inorganic compounds like water and carbon dioxide can be used to synthesise organic compounds under sunlight energy by green plants

5. STEADY STATE THEORY (COSMOZOAN OR PANSPERMIA) THEORY

This theory suggests that life has no origin. It has been available and there has never been any change and it will continue to be available. According to this theory life could have arisen once or several times in various parts of the universe and then remained the way it was.

THEORIES TO EXPLAIN THE MECHANISM OF EVOLUTION

DARWINISM

This theory was proposed by Charles Darwin from his voyage around the world which took him to many places particularly Galapagos Islands of South America. *His theory states that change in environmental conditions make organisms which are better adapted to survive and reproduce and transmit their alleles at the expense of the poorly adapted organisms which are gradually eliminated before reaching the reproductive age, thereby leading to the formation of new species from the pre-existing species.*

Darwin's theory is based on three observations and two deductions. In this theory Charles Darwin observed that;

1. Organisms within a population tend to produce far more off springs than what the environment can support.
2. Despite the tendency to increase the numbers of the species due to over production of off springs, populations actually maintain relatively constant numbers.
3. He also observed that different individuals show variations advantageous to their environment (i.e. the fit) while other individuals show variations disadvantageous to their environment (i.e. the unfit)

From the observations he concluded that there's **struggle for existence** within a population and so many individuals fail to survive or reproduce. Organisms always compete for the limited resources with each other in an effort to survive. This competition is based on the adaptations of organisms such that when variations in the environment factors exerts a selection pressure, individuals with best suited characters (variations) to the new prevailing environment survive and reproduce at the expense of those individuals who are poorly adapted that are eventually eliminated from the population, thereby limiting population size.

From these observations Darwin also concluded that in the struggle for existence individuals showing variations better adapted to their environment (the fit) survive and reproduce more off springs for the next generation than the least adapted organisms (un fit) which die before the reproductive age and fail to pass on their characteristics to the next generation. Individuals which survive pass on their favorable characteristics to the next generation. Individuals with unfavorable variations are eventually eliminated in the struggle for their existence. Nature therefore allows the survival of those organisms whose characteristics fit them in the prevailing environmental conditions and eliminates those with poor characteristics so that they are not given chance to survive and reproduce. This is called **survival for the fittest by natural selection**. Organisms which survive to reproduce are likely to produce off springs similar to themselves i.e. the like produces the like. This leads to the emergence of new species under the constantly changing environmental conditions.

DARWIN'S FINCHES

<p>The Galapagos finches show an example of adaptive radiation. It is assumed that a stock of ancestral finches reached the islands from the mainland and then, in the absence of competition, evolved to fill all the empty ecological niches occupied by other species on the mainland. The <i>large ground finch</i>, the closest to the mainland finch in form and function, has a typical finch-like beak for crushing seeds. The <i>cactus ground finches</i> have a long straight beak and split tongue for getting nectar out of the flowers of the prickly pear cactus. The <i>vegetarian tree finch</i> has a curved parrot-like beak with which it feeds on fruits and buds. The <i>insectivorous tree finches</i> have a similar beak which they use to feed on beetles and other smaller insects. The <i>Warbler finch</i> uses its slender beak to feed on small insects which it catches on the wings. The <i>woodpecker finch</i>, lacks a long tongue, therefore it uses its beak to pick up a stick which it uses to poke it a hole full of insects. When the insects emerge, the bird drops the stick and devours the insects (this tool handling is only thought to be in man and monkeys).</p>	
--	--

LAMARCKISM

According to Lamarck organisms acquire certain *structural and physiological characteristics* according to the *environmental need for survival*. These characteristics acquired are then passed on to the offsprings of the organisms *genetically*. Gradually a group of organisms better adapted to the environment are produced and therefore evolution occurs. Lamarck concluded that characteristics acquired through an organism's interaction with the environment can be inherited by the offsprings i.e. inheritance of acquired characteristics.

According to Lamarck when an organism constantly uses part of its body that part develops greatly to better fit in the environment. However, the part which is not constantly used begins to degenerate (Becomes vestigial).

Lamarck referred to this as *the principle of use and disuse*. For example, Lamarck speculated that earlier giraffes had short necks and time came when they over produced and competed for the existing vegetation. This made them to stretch their neck heights to eat the tall vegetation and eventually the necks became longer.

However, Lamarck was not scientific in his explanation because acquired characteristics cannot be passed on to the next generation. The use and disuse of somatic cells that make up body parts have no influence on gamete formation and cannot be inherited to cause evolution.

NOTE;

- A.** Natural selection is a process by which organisms that are better adapted to their environment survive while those that are less adapted are eliminated.
- B.** Natural selection promotes speciation (emergence of new species) as follows;
Individuals with unfavorable characteristics are less likely to survive long enough to reproduce as nature causes their death unlike those with favorable characteristics which survive long enough and reproduce. Over very many generations, their numbers in the population will decrease while for those with favorable characteristics their numbers will increase. Individuals with favorable characteristics breed with consequent increase in their numbers with in the population due to the development of a number of favorable variations in them.
The development of a number of favorable variations in these individuals over many generations greatly leads to the emergency of new species.
- C.** According to Darwin the original giraffes had variations in the length of their necks varying from short to long. When they over produced there was competition for the ground vegetation during which the short necked giraffes were eliminated while the long necked giraffes which could reach the leaves of the trees survived and therefore passed on their genes to the next generation which came with only long necks

Assignment;

Read and make briefs notes on

- a. disappearance of dinosaurs

NEODARWINISM (Modern synthetic theory of organic evolution)

This theory was improved from the views of Darwin by including in Mendel's genetic principles, ethology, paleontology, molecular biology and ecology.

This theory therefore suggests that in sexually reproducing organisms, there is always genetic variation which occurs during gamete formation as a result of *crossing over, mutations, random fertilization and cross*

breeding. This provides a *gene pool* from which natural selection occurs to eliminate the unfit individuals from the population.

Consequently the prevailing environmental conditions will favour and allow propagation of the fit individuals by eliminating individuals with unfavourable genes from the population according to variation of inherited characteristics

According to this theory, a population rather than an individual organism evolves and therefore it is the gene pool that evolves. Therefore, Neo-Darwinism theory is the theory of organic evolution by natural selection of inherited characteristics. Genetic recombination between sexually reproducing organisms produce most of the variations in the characteristics that make adaptations possible. New combinations of genes produce unique genotypes according to this theory whose phenotypes undergo *environmental selection pressures* which continually select and determine which genes pass on to the next generation.

Therefore phenotypic characteristics (variations) are determined by both genotypes of the organisms and environmental factors, upon which natural selection acts to give rise to new species.

NOTE:

- a. A **gene pool** is the total variety of genes and alleles present in a sexually reproducing population.
- b. A **selection pressure** is any environmental resistance factor that can increase or decrease the frequency of an allele within the gene pool through eliminating the unfit organisms from the fits ones thereby leading to an evolutionary change. A selection pressure may be predation, disease outbreak or competition.
- c. **Microevolution** is the change in the genetic makeup of a population or gene pool over many generations

EVIDENCE FOR EVOLUTION

The proof that evolution occurs or occurred includes the following;

1. Comparative embryology
2. comparative anatomy
3. Palaeontology
4. comparative biochemistry
5. cell biology
6. taxonomy
7. biogeography
8. Industrial melanism.
9. artificial selection
10. Resistance to drugs

COMPARATIVE EMBRYOLOGY

Embryology refers to the study of the developmental stages of embryos.

Critical observations of these embryos during various stages of growth such as cleavage, gastrulation and differentiation indicate that embryos tend to go through or repeat the developmental stages of their ancestors and this is called *ontogeny recapitulates phylogeny* i.e. the developmental stages (*ontogeny*) repeats (*recapitulates*) the evolutionary history of the ancestors (*phylogeny*).

The developmental stages of embryo reveal striking similarities between embryos of different species which shows that these species evolved from the same ancestor. The more closely related the species are the more they go through similar developmental stages due to having a common ancestor therefore organisms tend to show developmental patterns that their ancestors went through which proves that evolution occurs.

For example, all vertebrate embryos begin as one cell which undergoes cleavage (rapid cell division) to form many cells which later leads to the formation of organs (gastrulation) and later the whole/entire organism is formed through differentiation of the tissues to form systems.

However, some organisms remain as one cell an indicator that multi-cellular organisms evolved from unicellular organisms.

OTHER EXAMPLES

- Mammalian embryos grow within amniotic fluid, which confirms that the ancestral organisms lived in water.
- Mammalian embryo grows within the amniotic fluid confirms that the ancestral organisms lived in water
- At comparable stages of growth e.g. 1 month of growth, all vertebrate embryos possess the following features; A single blood circulation with a two chambered heart showing no separation between left and right halves a situation retained only in fish the ancestor of other vertebrates. Others include possession of a tail, visceral clefts and the gill pouches. In human embryos the gill pouches disappear leaving the Eustachian tube of the ear.
- A human embryo and a tadpole of amphibians possess a tail which later breaks. This indicates that amphibians and humans share the same ancestry.
- The larvae of a sea squirt and amphioxus possess a notochord like vertebrae embryo which is later replaced by the vertebral bones excepting amphioxus. This shows that all vertebrates have common ancestors.

PALEONTOLOGY (The study of fossils)

Fossils are preserved remains of an organism that lived long ago in sedimentary rocks. Paleontology the study of fossils of organisms that lived many years ago in form of impressions or imprints. Oldest fossils are found in bottom strata of sedimentary rock and possess simpler structures while present day fossils (recent fossils) are found in young top strata of sedimentary rocks and containing a variety of many complex organisms. This indicates a progressive change from simpler to complex forms which suggests that present organisms could have evolved from ancient organisms e.g. evidence also shows that the climatic conditions have been varied through the earth's crust, which explains differences in structure of fossils of common ancestry but located in different parts of the world due to sudden environmental changes. Organisms have been undergoing adaptive radiation to survive in these changes that bring about natural selection which progressively eliminate the unfit organisms leaving the fit.

When fossils are compared with the present day organisms, there are striking similarities and differences which is an indicator that ancient species are ancestors of the present species. This proves that the present day species have gradually evolved from ancient species and are not a result of sudden appearance

Fossils document the existence of now extinct species, showing that different organisms have lived on earth during different periods of the planet history. Fossils indicate the time at which species originated and became extinct (geological time scale) via carbon dating. This supports the disappearance of organisms due to natural selection of the fit against the unfit organisms.

The differences in fossils and living species also reveal the evolutionary trends that these organisms went through in the course of evolution to become more modified and complex i.e. they reveal that organisms change gradually in a course of evolution. Indeed most fossils found so far can be classified in to the same taxonomic groups with a present day living organisms.

Example

Fossil records indicate that amphibians evolved from fish and then gave rise to reptiles which finally evolved into birds and mammals.

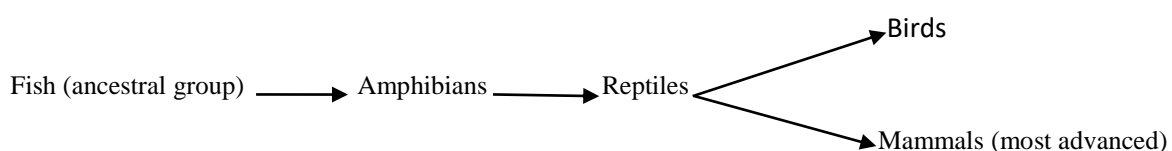

Such an evolutionary trend is an indication that organisms undergo modifications so as to fit in the prevailing environmental conditions by acquiring special adaptations for such environments. Paleontology shows that there's progressive increase in diversity and complexity of species as the old sedimentary rocks in bottom layers contain fewer and primitive forms while young rocks contain many and advanced organisms. This supports a theory of progressive increase in complexity of organisms,

Fossils also indicate the time at which species originated and became extinct i.e. geological time scale. This is because fossils, can be excavated from underground and then their age determined by carbon dating. From carbon dating an evolutionary trend the organisms, supplemented with similarities in structure, is established where by a group of organisms have better modified structures than another group.

Paleontology also shows that geographical regions and climatic conditions have varied throughout the earth's history and since organisms are adapted to particular environmental conditions the constantly changing conditions in the world may have created progressive changes in the structures of organisms as shown by the fossil records.

Fossils provide information about which taxon of organisms appeared first, survive for hundreds of years and then disappear later as more advanced forms of organisms appear, which shows emergence of advanced species and extinction of the primitive species. Thus fossils indicate times at which species originated and became extinct.

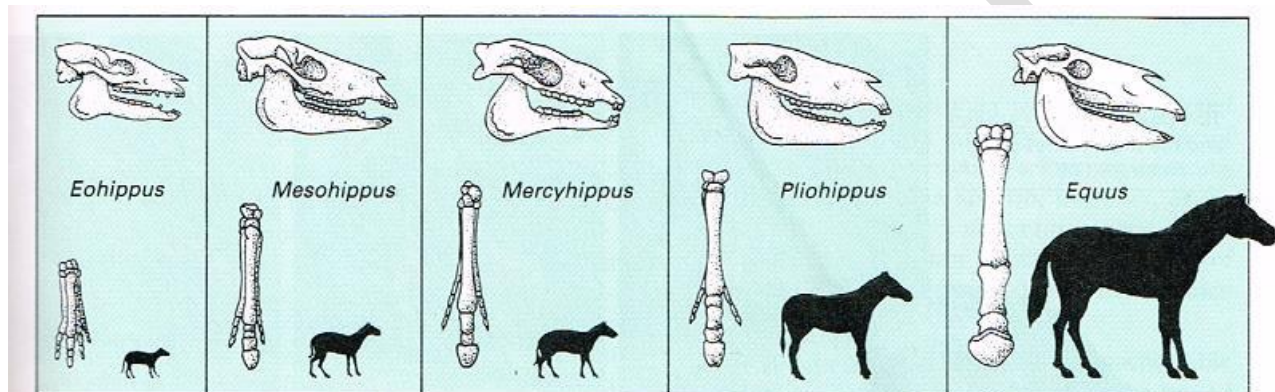

Note.

Paleontology is limited because the fossil record is incomplete so that few fossil forms are represented among organisms living today, as not all fossils have been dug up and not all life has been fossilised e.g. for invertebrates the whole body may decompose to leave an impression or a mould this is because which animal is fossilised and is discovered is a matter of chance. In addition, fossils are usually broken down by forces of nature and therefore paleontology gives incomplete information. However, paleontologists have constructed geological periods calculating the ages of the discovered fossils which are a strong evidence for evolution.

It should be noted that paleontology is limited as an evidence for evolution because extinction is a frequent event, so that only very few fossils are represented among organisms living today.

CELL BIOLOGY

The study of cell structure and physiology reveals a lot of evidence for evolution e.g. the presence of common cell component in different species serving the same function is a clear indicator that organisms having them have a common ancestor. Such structures include, mitochondria, ribosomes, endoplasmic reticulum, Golgi body, nucleus e.t.c.

TAXONOMY (CLASSIFICATION)

This is the grouping of organisms using their similarities and differences particularly in their structures. Classification is based on the presence of common homologous structure such as the pentadactyl limb.

Organisms with the same homologous structure are put under the same taxonomic group e.g. same phylum, class, order, e.t.c. which indicate that they evolved from a common ancestor e.g. all organisms under phylum chordata have a notochord and a post anal tail at least one time in their life time. This indicates that chordates (vertebrates) evolved from the same ancestor since the genes for these characteristics are inherited from generation to generation.

COMPARATIVE ANATOMY

The study of comparative anatomy brings out similarities in the structures which indicate a common ancestor for different species. Comparative anatomy proves that evolution occurred in organisms using homologous structures, where two or more species share a unique physical feature such as a complex bone structure or a body plan, which they may all have inherited from a common ancestor.

When *homologous structures* of organisms of different species are compared and found to be basically similar they indicate a common ancestor or an evolutionary trend of organisms. This is because homologous structure arises through *adaptive radiations*, due to the different environmental conditions in their habitat which make organisms possessing these structures become different species due to the differences in the environmental conditions.

Presence of homologous structures in different species of organisms is an indicator of evolution through adaptive radiation i.e. specialisation of homologous structures to serve different functions in different environment in apparently similar organisms e.g. the mouth parts of butterfly are modified for sucking while that of cockroaches are modified for biting and chewing. The hind legs of ducks are modified for swimming by being webbed while those of rats are modified for hopping to bring about fast locomotion.

Homologous structures are built on the same basic plan in different species of the same ancestral origin but are modified to perform different functions in different species due to adaptive radiation e.g. pentadactyl limb system in vertebrates. This similarity in basic plan suggests that organisms possessing similar homologous structures have a common ancestor

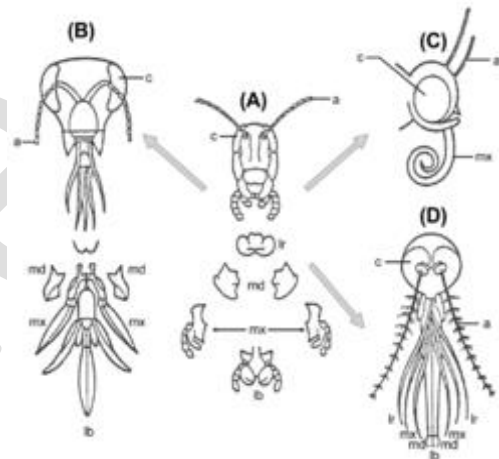

In addition, **vestigial organs** possessed by some organisms give evidence of changes from ancestral conditions to the present conditions and seem to represent a revolutionary link with the previous species. The vestigial organs include the vestigial tail and appendix of humans which suggests that they were well developed in the ancestors of man but later degenerated and became functionless in man. This shows that many organs have changed in the course of evolution e.g. the salivary glands of the snake have been modified into poison glands.

Comparative anatomy proves that divergent evolution occurs arising through great modifications of homologous structures due to adaptive radiation and also proves that convergent evolution occurs in species of different ancestral origin making them have similarities due to natural selection and adaptation to the same ecological conditions, making their **analogous structures** perform the same function.

Comparative anatomy therefore confirms that the present organisms are descendants of the ancient organisms through change of structures by adaptive radiation.

NOTE

- Adaptation refers to the structural and physiological modifications of an organism brought about by evolution to enable the organism survive in its environment.
- Homologous structure** and physiological functions reveal *divergent evolution* i.e. the evolution of organisms from a common ancestor through great modifications of their homologous structure to serve different functions in different environments due to adaptive evolution.

c) Homologous structures are those structures that have the same basic plan in different species of organisms having the same ancestral origin but modified to serve different functions in different environments due to adaptive radiation e.g. the *pentadactyl limb* of vertebrates which is modified in different species of vertebrates for different functions, the wings of birds and legs of horses as well as the limbs of man are all similar in number of arrangement of bones because they have evidently evolved from the same type of ancestral appendage.

d) The modifications of homologous structures include the following

i. Monkeys

The pentadactyl limb is modified for grasping tree branches by being highly flexible while in man it is modified as a tool of manipulation.

ii. In pigs and dogs this limb is modified for walking by having hooves which are hard enough to support the process of walking. While in rodents it is modified for digging tunnels by having highly flexible toes and blunt claws.

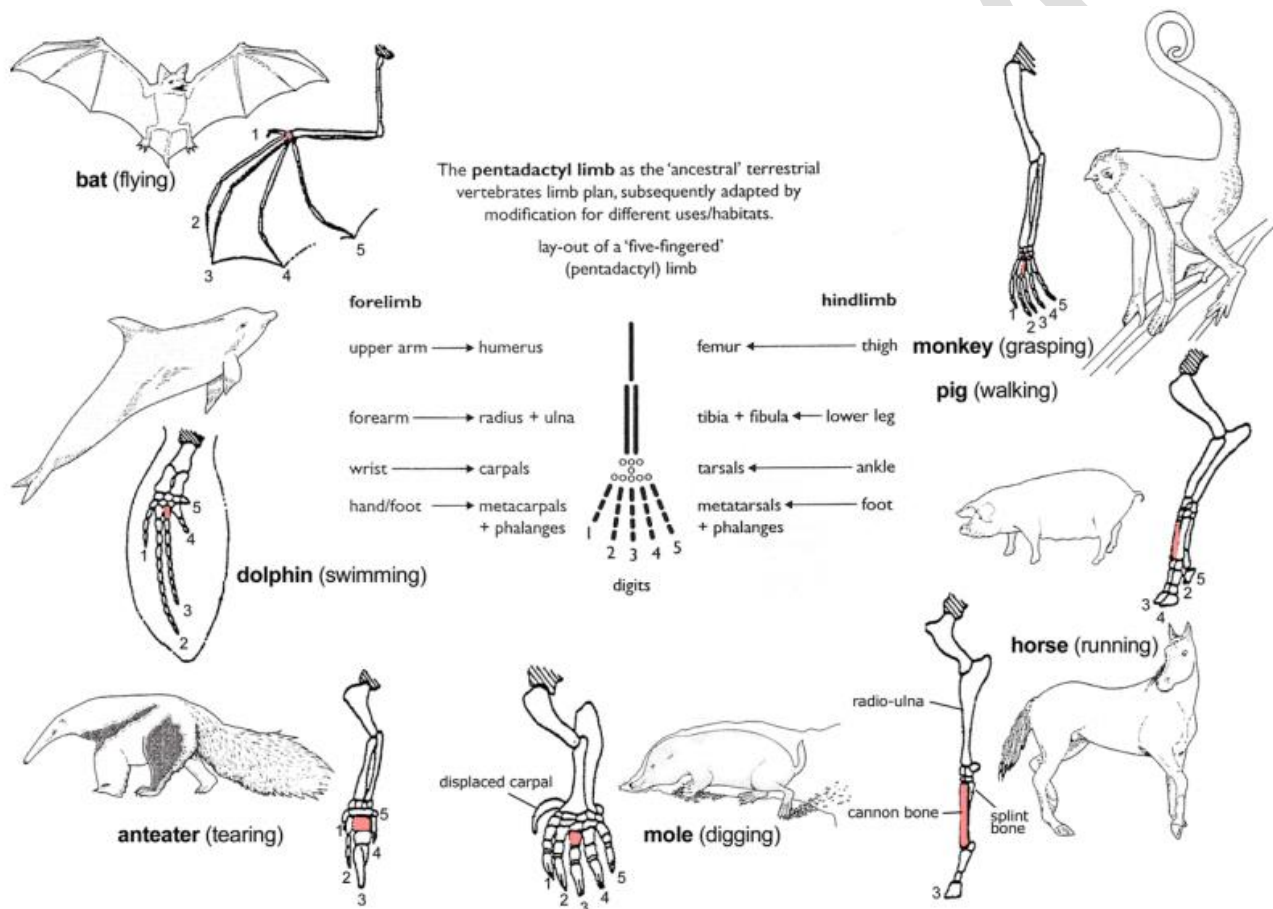

e) Presence of homologous structures in different species of organisms is an indicator of divergent evolution from common ancestor as they indicate **adaptive radiations**. Adaptive radiation is important because it enables organisms with the same basic structure (same homologous structures) to exploit different *ecological niches* thereby decreasing competition for resources.

f) **Analogous structures and convergent evolution**

These are structure having different basic plan in different organisms but serving the same functions in organisms of different ancestral origin e.g. the wings of bats and insects (both are used for flight but have different structures and are in organisms of different ancestral origins, the hind legs of a frog and grasshopper, the eyes of octopus and vertebrates, fins in fish and the penguins, storage organs of the potatoes and the sweet potatoes e.t.c.

These analogous structure and physiological functions reveal **convergent evolution** i.e. the type of evolution which creates similarities in organisms of different ancestral origins due to natural selection and adaptation to the same environmental conditions making such organs perform the same functions.

Convergent evolution suggests that organisms from different ancestral origins tend to evolve along the same lines.

COMPARATIVE BIOCHEMISTRY AND PHYSIOLOGY

This proves evolution in that similarity in chemical composition and metabolic properties of all cells suggests a common ancestor to living organisms e.g. similarity in protoplasmic chemical contents like enzymes in different species. At the most basic level, all living organisms share;

- the same genetic material (DNA)
- same or highly similar genetic codes
- same basic process of gene expression like transcription and translation.
- Same molecular building blocks such as amino acids for proteins.

These shared features suggest that all living things descended from a common ancestor that had DNA as its genetic material, used the genetic code and expressed its genes by transcription and translation. Other evidence under comparative biochemistry include;

A. SEROLOGY (serum studies)

Blood tests are based on antigen antibody reactions, which antigens and antibodies are synthesised according to the genetic makeup of the organism. Blood tests indicate that all primates have the ABO blood group system and the rhesus blood group system. This indicates that they possibly originated from the same ancestors and that man could have evolved from primitive primates such as monkeys, baboons, gorillas e.t.c.

Since blood tests are based on antigen antibody reactions, when serum from different species is mixed this reaction occurs if the species are related leading to the formation of a precipitate. The larger the precipitate formed, the more closely related the two species are, by having similar antigens and antibodies that can easily react, indicating that the two species are closely related as they have similar protein structure.

B. AMINO ACID SEQUENCE

Proteins have similar amino acid sequences in different species which shows that these species have a similar ancestral origin e.g. chemical analysis have shown that cytochrome C has 35 amino acids in humans, rabbits, fish, snakes e.t.c arranged in the same sequence. This reveals the common ancestor for vertebrates since the synthesis of cytochrome C is the base of the gene frequency of organisms controlled DNA.

C. DNA HYBRIDISATION

This is where DNA molecules of the different organisms which are assumed to be related are separated into individual strands. When these DNA strands are mixed together they may show *complementary base pairing* to reform the DNA molecules of different species whose strands were mixed earlier depending on how closely related these species are. Pairing of the separated DNA bases of different species indicates that the organism have a common ancestor and are therefore closely related.

D. BLOOD PIGMENTS

These provide evidence to evolution because some organisms have similar blood pigments and therefore believed to be closely related as they belong to different species e.g. haemoglobin exists in all vertebrates and also in some few invertebrates such as the earthworm an indicator that possibly vertebrates evolved from invertebrates. Other blood pigments used as evidence for evolution include the following; Chlorocruorin (made of iron) found in some lower organisms called Polychaetae e.g. the lugworm. Haemocyanin (made of copper) found in molluses and arthropods such as crustaceans.

These pigments indicate the common ancestor of organisms having them

E. CHROMOSOME STRUCTURE

Some organisms of different species have the same chromosome structure and the same chromosome number which is evidence of evolution since the chromosomes in their cells are an indicator of the same ancestral origin. For example humans, gorillas and chimpanzees have 46 chromosomes.

BIOGEOGRAPHY (SPECIES DISTRIBUTION/GEOGRAPHICAL ISOLATION)

In the past, the present day continents were all joined together to form a single land mass known as Pangaea which floated on the denser molten core of the earth. During this period all animals were mainly found in the northern hemisphere particularly North America, from where they used to migrate to other areas and later returned to the same northern hemisphere. However, due to the pressure in the earth crust (plate tectonics) the Pangaea split up into the current continents which became separated by water bodies immediately.

N.B. Continental drift is the movement apart of land masses (continents) due to plate tectonics.

The splitting of the Pangaea into the current continents resulted in geographical isolation of animals which got trapped in these new continents and therefore in the new environmental conditions since they could not cross the large water bodies. This isolation made animals in the new continents to undergo adaptive radiations so as to survive in the new environmental conditions permanently which resulted into the formation of many new species and therefore evolution of new species.

The existence of closely related species occupying similar ecological niches in different continents together with the fact that some species exist in only one particular continent supports the origin of organisms from the common ancestor mainly from North America. In addition, the absence of more advanced forms of organisms from a region usually indicates the prior geographical separation of that region from the Pangaea or from other regions of the world where these organisms originated.

Groups of organisms that already had evolved before splitting of Pangaea are distributed worldwide in similar ecological niches in different continents. In contrast, groups of organisms that evolved after breakup of Pangaea into current continents appear uniquely in smaller regions of the world such unique allopatric species on islands like Galapagos Fiches. Marsupials (and not placental mammals) evolved in Australia because Australia was geographically isolated by water for millions of years which made those species able to evolve without competition from advanced placental mammals elsewhere in the world.

Indeed the distribution of fossils and the present day organisms can be precisely related to the positions of continents in the past before the Pangaea split up. For example the Bison of North America has similar adaptations to the Zebra of Africa, an indicator of the same ancestral origin. The lung fish species are found separately in tropical areas of South America (*lepidosiren*), Africa (*protopterus*), Australia (*neoceratodus*). These species acquired different structures in different tropical continents by adaptive radiation which made them become separate species.

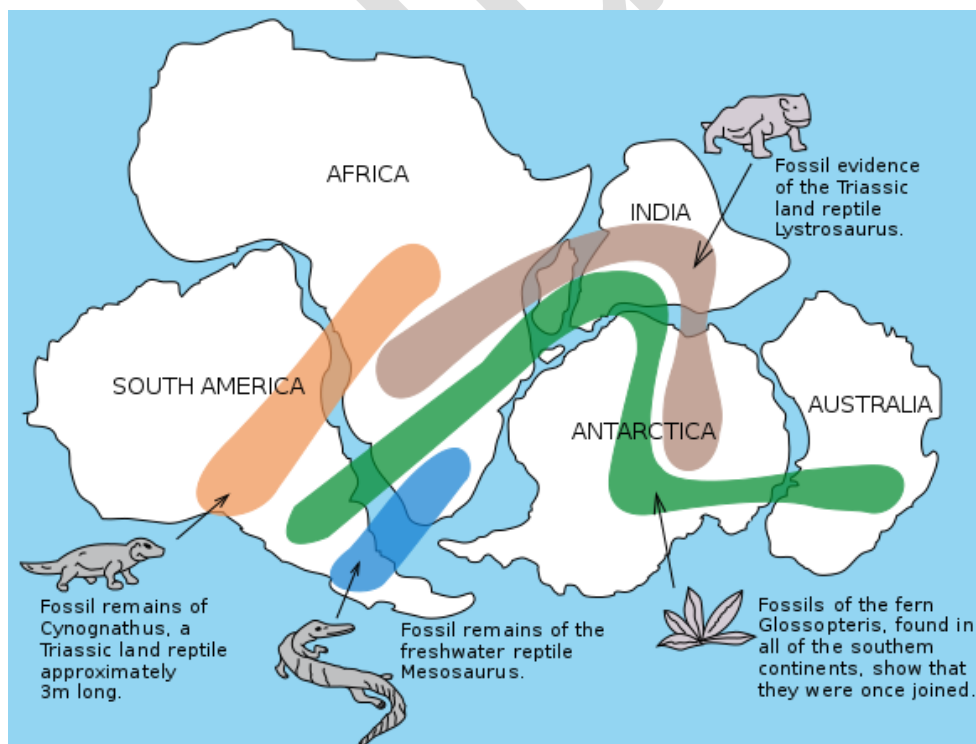

Biogeography also shows that in evolution, the more adapted organisms survive at the expense of the poorly adapted ones due to changes in environmental conditions e.g. when placental mammals (eutherian mammals) evolved in the world, Australia had been geographically isolated from the Pangaea and therefore placental mammals never migrated into Australia.

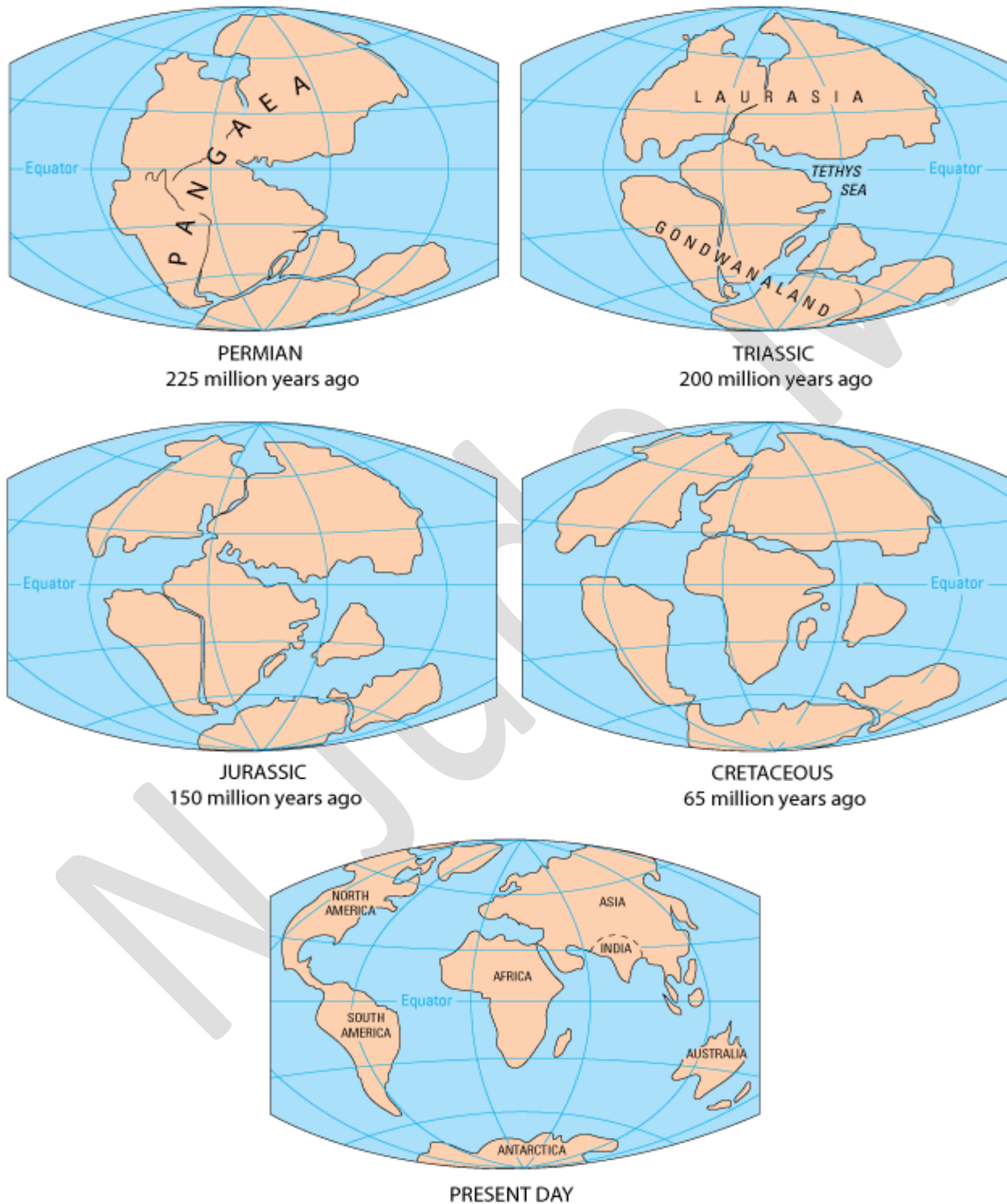

In other parts of the world, these mammals eliminated the more primitive marsupials e.g. the kangaroo and monotremes e.g. the dark billed platypus from their ecological niches except Australia which earlier broke

away. This is supported by the many fossils of these primitive mammals that are found in most of other continents.

INDUSTRIAL MELANISM

This supports evolution because industrial activity changes the background of an area from white to black due to soot (smoke) from these industries, which contains sulphur dioxide gas that kills the lichens thereby changing the background to black. This environmental change affects the predation selection pressure by promoting camouflage of the melanic organisms against predators on the black background. Greater predation of the non-melanic forms of organisms that are easily seen on the black background compared to the inconspicuous melanic forms, selects the few melanic forms to survive, reproduce and greatly increase in number as the non-melanic organisms greatly decrease in number.

For example, before industrialisation in Britain, the majority of the peppered moth, *Biston betularia* were white due to their camouflage against the predatory birds on the white background made of mainly lichens and very few moths were black but during industrialisation, sulphur dioxide killed the lichens, thereby changing the background from white to black, which allowed the black mutant peppered moths to survive and greatly reproduce to increase their numbers as the white peppered moths were decreasing in numbers.

The camouflage provided by the black environment sets up a basis for **natural selection** that allowed the black forms of moth to survive and reproduce rapidly while the white forms of moth were being selected against as they became conspicuous to predators. This confirms that evolution occurs via natural selection when the environment changes. This confirms that evolution occurs via natural selection when the environment changes

CROSS BREEDING/ ARTIFICIAL SELECTION

Artificial selection is a type of selection where humans eliminate organisms with undesirable characteristics, leaving only those with desirable characteristics which may become new species after several generations. Humans ensure that the reproductive potential of species with desirable characteristics increases so that their alleles are passed on to the next generation. Those without the desirable characters have their reproductive potential decreased and their alleles eliminated through segregation, extermination and sterilization. This makes the population more divergent (vary greatly) from the original population due to hybridisation.

When closely related different species of organisms are allowed to cross breed together, through selective mating, selective propagation or selective pollination, they can develop a new breed (**hybrid vigour**). Hybrids have better characteristics like increased size, high yields, quick maturity and increased resistance to diseases. Selection for these advantageous characteristics over several generations may lead to emergence of a new species with better characteristics than the parental organisms (ancestral organisms) due to increase in allele frequency of the hybrid characteristics in the population caused by a **directional selection pressure** exerted on populations by superior characteristics.

Continued selective breeding by humans has produced the varieties of domestic animals and plants of agricultural importance seen today. Therefore from cross breeding new species can be easily evolved through human activities. Therefore humans are preserving animal and plant genes which are considered to be desirable and eliminating those genes which are undesirable via extermination, castration or isolation of organisms with inferior features. Selection for the desirable characteristics over several generations leads to the formation of new species. This replicates how evolution could have taken place in the past.

RESISTANCE TO DRUGS AND PESTICIDES

When these are first administered a large population of a non-mutant strains die leaving very few mutant strains. The few mutant resistant strains reproduce greatly and pass on their mutant gene for resistance against the drug or pesticide to the next generation. Eventually the resistant strains of the pest or bacteria become the majority in the population and after several generations may become new species. In addition some plant species grow on the heap of highly poisonous metals such as gold, copper, lead, silver, e.t.c because such plants have mutated and developed the ability to tolerate such poisonous heavy metals.

SELECTION

There are 4 major types of selection as a key factor for evolution and these include the following;

- A. Natural selection
- B. Sexual selection
- C. Kin and group selection
- D. Artificial selection

NATURAL SELECTION

This is a process by which organisms that are better adapted to their environment survive and reproduce while those that are poorly adapted to their environment are eliminated.

Natural selection promotes speciation as described below; Natural selection occurs because different individuals in the population show variations advantageous to the environment while others show variations disadvantageous to their environment. Individuals with favorable variations in the population survive, grow and reproduce thereby passing on their favorable characteristics to the next generation while those with unfavorable variations are less likely to survive long enough to reproduce and are therefore eliminated in the struggle for existence by the various *selection pressures* as nature selects against them.

A selection pressure is any environmental resistance factor that can increase or decrease the frequency of an allele within the gene pool by eliminating the unfit individuals from the population and leaving the fit to reproduce, thereby leading to evolutionary change.

A selection pressure may be predation, disease outbreak or competition.

Environment influences natural selections in that it exerts a selection pressure on organisms' population, which eliminates those with unfavorable variations from the population.

Natural selection is important in the following ways;

- i. It promotes the emergence of new species under the constantly changing environmental conditions.
- ii. It enables organisms which are best adapted for a particular environment (the fit) to survive and reproduce there by passing on their genes to the next generation.
- iii. It ensures that undesirable genes are eliminated from the population as it causes elimination of the unfit organisms.
- iv. It ensures that the population size is supported by the given environment as it maintains the carrying capacity of the habitat

There are 3 types of natural selection and these include the following

- I. Stabilising selection
- II. Directional selection
- III. Disruptive selection

I. STABILISING SELECTION

It is defined as the selection which occurs when selection acts to eliminate both extremes from the phenotypes of the population resulting into increase in the frequency of the already common intermediate phenotype

If there is a **little change in the environmental conditions and little competition within the population** individuals which do not show adaptation to extreme conditions survive and reproduce while those which show adaptations to extreme conditions die out without reaching reproductive age i.e. both extremes are removed from the population leaving only organisms with intermediate phenotypes.

Examples of the extreme conditions include very hot or very cold climate. Organisms which are adapted to such extreme conditions die because little change in the environment does not result into such extreme conditions. This stabilises the population as *it removes extremes within the population hence reducing chances of evolution.*

Stabilising selection therefore occurs when optimum environmental conditions do not favour organisms with extreme characteristics but instead favour those with intermediate phenotypes within a population. The extreme phenotypes are eliminated by natural selection because they are adapted to extreme conditions.

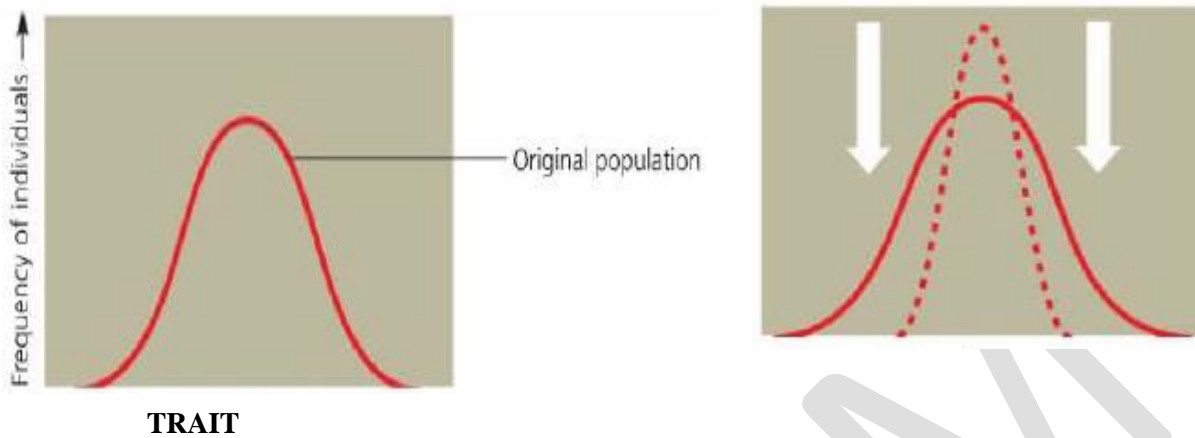

Examples **include;**

- i.** Wing length in hawks. wing spans larger or smaller than the optimum wing length will have reduced breeding potential which eliminates those birds with wings larger or smaller than the optimum.
- ii.** Similarly children born with extreme weights (very small or very large weight) die while those born with intermediate weight (3 to 4 Kgs) have the highest chances to survive.
- iii.** In ducks and chicken, the eggs laid with intermediate weight have the highest chances of hatching compared to the ones laid with extreme weights.

II. DIRECTIONAL SELECTION

This is the type of selection which acts to eliminate one of the extreme phenotypes from the population thereby increasing greatly the frequency of the other extreme phenotypes in the population.

Directional selection occurs when **gradual changes** in environmental conditions favour a particular extreme characteristic in the population to survive more as the intermediate and the other extreme characteristic are less favoured which lowers their population.

If there is a gradual change in environmental conditions organisms that are best adapted to the new environmental conditions survive and breed at the expense of the poorly adapted ones which get eliminated. This selection occurs so as to eliminate one extreme character from a group of phenotypes there by making the genes promoting this extreme phenotype become less frequent in the population as compared to the frequency of the genes promoting another extreme phenotype in the population with beneficial characteristics it therefore reduces the frequency of organisms in the population with poor characteristics.

This kind of selection brings about evolutionary change by producing a selection pressure which favours increase in frequency of the new alleles in the population usually of the extreme characteristic. Therefore it exerts a selection pressure which moves the mean phenotype towards one extreme phenotype.

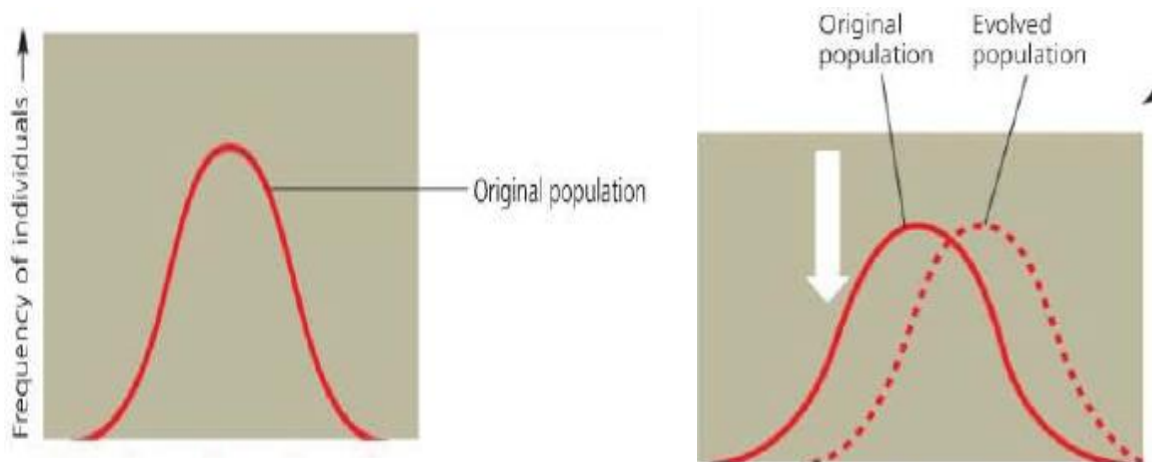

It is the commonest type of selection. And examples include industrial melanism of the peppered moth (*B. betularia*) in England whereby the black peppered moths are the majority and the white peppered moths are extremely very rare. It also includes artificial selection whereby humans promote the survival of organisms with beneficial characteristics and cause those with poor characteristics to become less frequent in the population.

III. DISRUPTIVE SELECTION OR DIVERSIFYING SELECTION

Disruptive selection is defined as the selection within a population which occurs when two contrasting environmental conditions favour the survival of extreme phenotype within the population and does not favour individuals with intermediate phenotypes resulting into two discrete forms of the species (or polymorphs) each adapted to one set of extreme conditions.

If the **environment takes a number of distinct/discrete forms in its variations** e.g. very hot climate or temperature which suddenly changes to rapidly very cold with no intermediate temperatures, selection may occur to favour two discrete forms in the population with each form of the species adapted to one set of the extreme conditions. This selection rapidly causes evolutionary change by splitting the population into two **demes** (subpopulations) which after several generations may become new species if gene flow between the demes is prevented for many generations. This reduces intraspecific competition between the demes and so resources are made available for the two demes which increases their survival. A **deme** is a genetically isolated population that forms a new species.

Examples of disruptive selection include organisms adapting to very cold conditions and very hot conditions but not to intermediate conditions, the different beak sizes of the African seed cracker finch bird (*Pyrenestes astrinus*). Populations of these birds contain individuals with large and small beaks but very few individuals with intermediate sized beaks. The large beaks are used for opening very tough seed coats while the small beaks are used for opening very small seeds. The intermediate beaks are unable to open both large and small seeds and are therefore selected against by lack of food. Other examples include; A, B, O blood group system and red green color blindness in humans.

Disruptive selection occurs due to **selection pressures acting from within a population** usually as a result of increased competition for resources which may push the phenotypes away from the population mean towards the extremes thereby leading to the formation of new species. This can split the population into two new demes. If **gene flow** between the demes is prevented, each deme may give rise to a new species, due to the different selection pressures exerted on each deme in the different extreme conditions. **Gene flow** is the movement of alleles from one population to another mainly through breeding. The genetically isolated population usually undergoes selection to form a new species.

Disruptive selection may result into appearance of different phenotypes within the population, a phenomenon called **polymorphism**. Polymorphism is a phenomenon whereby forms of organisms of a given species show differences in body structure and reproductive potential which determines their roles in the habitat.

There are 2 types of polymorphism namely;

- i. Stable or balanced polymorphism.
- ii. Unstable or transient polymorphism.

i. STABLE OR BALANCED POLYMORPHISM

This is a form of polymorphism in which different forms of a **species co-exist** within the same population in a **stable environment** and their genotype frequencies show equilibrium as each form has a selective advantage of equal intensity.

This type of polymorphism selects for the heterozygotes and gives them an advantage over the homozygotes. In humans, sickle cell trait individuals (heterozygotes) do not suffer from malarial infections as compared to the homozygous individuals.

Examples include;

- A, B and O blood group system.
- Red-green colour blindness.
- Workers, drones and queen bees.
- Workers, queen and soldier termites.

ii. UNSTABLE OR TRANSIENT POLYMORPHISM

This is a form of polymorphism which arises when different forms of species exist in a population undergoing a strong selection pressure which results into one form having a higher genotypic and phenotypic frequency from another e.g. the melanic and non-melanic forms of peppered moth (*B. betularia*) in England where the melanic form has a higher frequency in industrial areas and a very low frequency in the rural non-industrialised areas.

Polymorphism increases adaptation of organisms to their environment which sets up natural selection in the population hence allowing evolution to occur.

Directional Selection

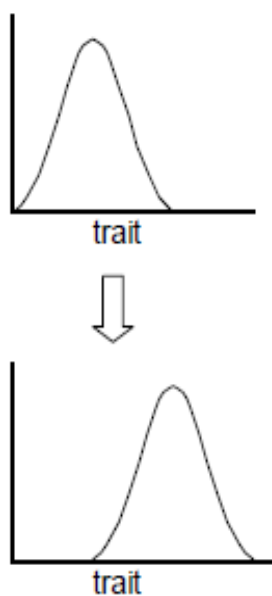

Stabilising Selection

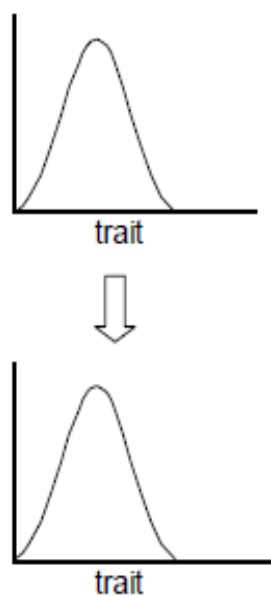

Disruptive Selection

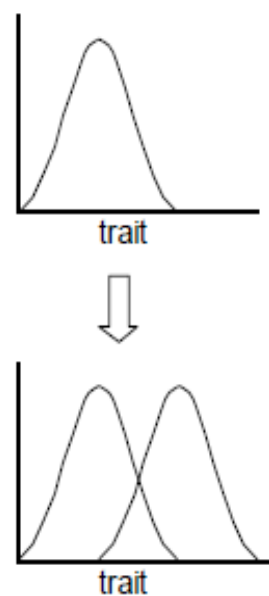

ARTIFICIAL SELECTION

This is where humans deliberately allow some organisms with desirable characteristics to survive, reproduce and pass on their genes to the next generations while preventing other organisms with undesirable characteristics to survive and reproduce. This eventually leads to the formation of new species having beneficial characteristics.

SEXUAL SELECTION

This is where organisms' mating success is selected for or against depending on the organisms' sexual behaviours and sexual structural dimorphism.

Sexual dimorphism is a situation where by different sexes have different or unique morphological makeup's for sexual attraction (secondary sexual characteristics) to the members of the opposite sex e.g. the male birds have bright plumage (feathers) so to attract the female while the females have dull plumage purposely for camouflage during incubation of their eggs.

Sexual selection brings about preservation of species because different species have specific reproductive behaviors and genitalia. This brings about sexual selection which contributes to evolution because different species adopt unique reproductive behaviors and genital organs during the course of evolution which restricts reproduction within a particular species only, thereby preventing inter-breeding within different species.

Organisms which are sexually selected for reproduction, reproduce and pass on their genes to the next generation, which causes variations in the population by bringing about natural selection and formation of new species. Organisms which are selected against reproduction are described as **genetically dead** organisms such as the sterile organisms. **Genetic death** is the failure of an organism to reproduce and pass on its genes to the next generation which may disappear from the gene pool upon death of such an organism.

Sexual selection is important because it brings about preservation of the species, as different species have specific reproductive behaviours and genitalia which allow reproduction to occur only within that particular population. This enables sexual reproduction to contribute to evolution because different organisms have unique reproductive behaviours and genital organs which restricts reproduction within one particular species only thereby preventing interbreeding between different species. Sexual selection leads to evolution

NOTE:

- i. **Unrandom mating.** This is the selective choosing of the sexually fit individuals in a population for mating. This ensures that some individuals in a population that are sexually fit have an increased reproductive potential than others that are sexually unfit. The alleles of the sexually fit individuals are likely to be inherited in subsequent generations. Individuals that are sexually unfit for mating may not be selected for mating hence their alleles are less likely to be inherited in subsequent generations and such alleles may be eliminated from the population over several generations. This results into a divergent population from the parental population that is better adapted for reproduction and survival. Over several generations, this divergent population may form new species.
- ii. **Genetic load:** is the existence within the population of disadvantageous alleles in the heterozygous genotypes which enable them to be easily transmitted by carriers to the next generation e.g. the existence of the sickle cell trait individuals in human population. Genetic load can also be defined as a condition when a population harbors disadvantageous alleles in its gene pool due to the heterozygous advantage of the carriers. Genetic load is advantageous because it confers the selective advantage of the phenotype in certain environmental conditions e.g. a sickle cell trait individuals are highly resistant to malaria.

KIN AND GROUP SELECTION

Kin selection is a form of selection where an animal tries to save the lives of other related animals but usually risks its life for others e.g. the worker bees sting the enemy that has attracted the bee hive but accidentally if their sting breaks the worker bees dies at the expense of other bees in the bee hive.

Group selection is where an animal tries to guard other members of the species against danger although not related to them e.g. some birds try to alert chicken of the presence of eagles, cattle egrets alert cattle and buffaloes of the incoming danger by suddenly flying away from the animals.

This kind of behaviour where an individual animal sacrifices its own life purposely to save some other individuals against enemy is known as **altruistic behaviour**.

SPECIATION

This is the process by which one species splits into two or more sub-species which gradually develop into different genetic lineages to form new species.

A species is a population whose members can interbreed and produce viable fertile offsprings, but are unable to produce viable fertile offsprings with members of other populations.

A single species may give rise to new species i.e. **intraspecific speciation** e.g. breeding organisms that are pure breeds but one having better characters than another which results in the formation of a hybrid, with hybrid vigor, that doesn't resemble any of the parents also two different species may interbreed and give rise to one new species i.e. **interspecific hybridisation**

INTERSPECIFIC HYBRIDISATION

This is the form of **sympatric speciation** which occurs when a new specie is produced by the crossing of individuals from two unrelated species.

A Fertile hybrid usually appears and only increases the chances of chromosome mutations to occur in that hybrid which makes it better adapted to the environment. Such hybrids are normally formed by **allopoloidy** e.g. a cross between cabbage and radish.

An allopolyploid is a fertile individual that has more than two chromosome sets as a result of two different species interbreeding and combining their chromosomes to form infertile F_1 hybrids, but due to non-disjunction the F_1 hybrids form fertile F_2 hybrids.

As formed in the above cross, during meiosis to the form F_1 hybrid, the chromosomes from each parent cannot pair together within the gametes to form homologous chromosomes and this makes the F_1 hybrids sterile. However, **non-disjunction** of F_1 hybrids produces gametes within diploid sets of chromosomes ($2n=18$) to form tetraploids (F_2 hybrids) which are fertile. Homologous pairing can occur in meiosis and F_2 hybrids since the two sets of parental chromosomes are present.

Non-disjunction is an error in meiosis or mitosis in which members of a pair of homologous chromosomes or a pair of sister chromatids fail to separate properly from each other.

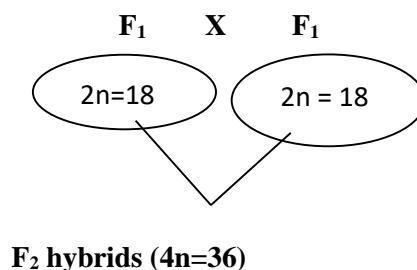

MECHANISM OF SPECIATION

An isolation mechanism is the one that tries to maintain the gene pool of a genetically isolated population by preventing successful inter-breeding with members of different species but restricting reproduction within the members of the same species.

For the development of a new species to occur the gene flow within the isolated populations (sub-species or demes) must be interrupted or stopped by **isolating mechanisms** to ensure isolated populations stop inter-breeding. The various isolating mechanisms isolating the two species may be **geographical, reproductive or genetic**.

The process of speciation, is initiated by the isolation of species using isolation mechanisms which occurs for a long period of time. This results into the splitting of one population into two or more separate sub-populations or demes for a long time each of which will remain with its own gene pool so that any new variations that arise within these sub-populations will not flow up to the other populations. This makes these sub-populations to become independent populations after a long time of separation. The demes must be isolated from one another to avoid exchange of genes between them in a single population. This encourages **gene differentiation** which results into the formation of the new species. Gene differentiation refers to the adaptation of genes to particular environmental conditions. In addition *mutation and selection* can take place independently in the two demes, causing each of the demes to develop into a distinct species. This is because when a deme is isolated, new variations which arise in each deme via mutation will not flow to other demes and so, mutation, natural selection and gene differentiation occur differently. This makes these demes to become independent populations or new species after a long time of separation by geographical, genetic or reproductive isolation. Changes in allele and genotype frequencies within the isolated populations due to the effects of natural selection on the range of phenotypes produced by mutation and sexual recombination lead to the formation of the sub-populations which become new species after several generations. If isolation persists for a long period of time and the sub-species come together to occupy the same area they may not inter-breed and therefore they will be described as new species.

NOTE; if the new species formed from each deme come together to occupy the same area, they cannot interbreed successfully but competition between the different species would occur. The less adapted species would be eliminated leading to the reduction in the number of species. Alternatively, the species may occupy different ecological niches thereby avoiding direct competition between the species hence all the species would survive.

Isolation mechanisms are significant in evolution because they permit stabilisation of the population, generation after generation, and also they enable organisms to evolve along different lines as they prevent inter-breeding. This isolation mechanism is possible as a result of various isolation mechanisms described below;

A. GEOGRAPHICAL ISOLATION

This is isolation whereby the population splits into sub-populations or demes due to separation by geographical barriers such as larger water bodies, mountains and deserts which prevent the sub-populations from inter-breeding to exchange their demes. This may occur when some members migrate or are dispersed, or when the geography changes catastrophically e.g. earthquakes, floods, volcano eruptions or gradually e.g. erosion, continental drift. This may lead to evolution in that when species become separated geographically they undergo adaptive evolution because they experience different selection pressures due to the different abiotic and biotic factors within their environments, which brings about divergent evolution. Even if the abiotic and biotic factors are the same, the populations may change by random genetic drift, especially if the populations are small.

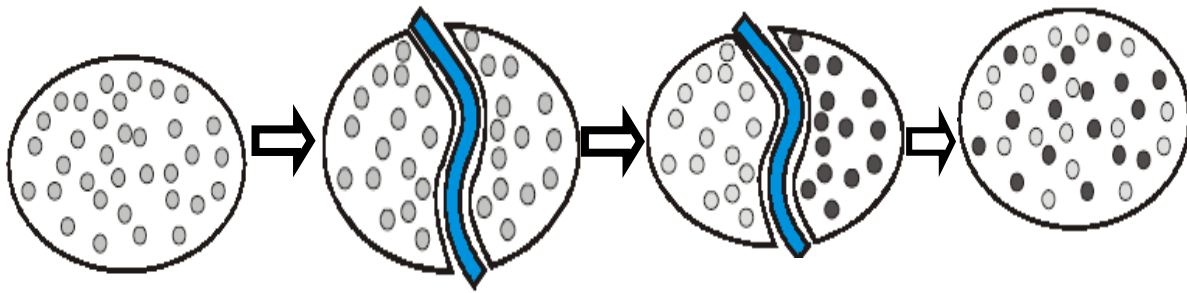

If the separated population come together after many generations each may have changed physiologically or genetically making inter-breeding difficult and will therefore be called new species. The new two populations formed therefore adapt to the different environmental conditions as they are separated by a geographical barriers and such species are called **allopatric species**.

Allopatric speciation is therefore the evolution of new species due to separation by geographical barriers e.g. evolution of Darwin's finches of Galapagos Islands.

B. REPRODUCTIVE ISOLATION

This is the existence of biological factors (barriers) that impede members of two species from producing viable, fertile offsprings.

It involves the stopping of free inter-breeding by individuals of a population due to differences in courtship behavior and a non-correspondence of the genitalia even if they occupy the same habitat. This divides the population into two or more categories and genitalia within the same area.

Reproductive isolation arises because during evolution, different species acquire unique sexual behaviours, thereby making them stay together in the same area. This brings about **sympatric speciation** i.e. the evolution of new species due to genetic or reproductive isolation in the *same geographical area*. The species formed are called **sympatric species** e.g. the evolution of a lion and hyena that live in the same habitat.

Reproductive isolation brings about speciation in that it leads to differential reproduction occurs only within a few individuals of the population that have similar courtship behaviours and genitalia. Reproduction therefore occurs in a few individuals who are better adapted for reproduction and therefore mutation, natural selection and gene differentiation occur only in these few individuals. This causes new characteristics to accumulate within only this interbreeding sector which may become a new species. This reproductive isolation occurs through the following isolation mechanisms;

- mechanical isolation
- seasonal isolation
- behavioral isolation
- habitat isolation

These isolation mechanisms work in such a way that organisms in the same geographical area belonging to different species fail to interbreed (pre-mating isolation mechanism)

i. MECHANICAL ISOLATION

This is whereby the genitalia of the two organisms of the opposite sex of different species are incompatible (non-correspondent) in that mating and fertilization cannot occur.

ii. SEASONAL ISOLATION (TEMPORAL ISOLATION)

This is where the reproductive organs of organisms of different species of opposite sex mature at the different times or seasons of the year thereby resulting into fertilisation failure. The mating seasons may not overlap therefore between different species e.g. the stamens and pistil of flowers of different

plants mature at different times of the year. Many animals usually have different reproduction systems i.e. protandry and protagyny

iii. **BEHAVIOURAL ISOLATION**

This is where organisms show differences in courtship behaviours such that there is no attractiveness that can lead to mating. Courtship rituals/activities that attract species for mating are unique to a species and are very effective reproductive barriers even between closely related species.

iv. **HABITAT (ECOLOGICAL) ISOLATION**

This is where habitat preferences keep members of different species or demes apart though living in the same area therefore preventing mating and fertilisation between them.

NOTE: another form of reproductive isolation occurs through **unrandom mating** i.e. selective choosing of individuals in the population for mating. Unrandom mating ensures that some individuals in the population have increased **reproductive potential** than others and therefore their alleles are likely to be inherited in subsequent generations. Individuals with unfavorable characteristics for reproduction may not be selected for mating and therefore their alleles are less likely to be inherited in subsequent generations which alleles may be eliminated from the population over several generations. This results into a divergent population from the parental population i.e. a new population different from the parental population due to new variations acquired. This divergent population is better adapted for reproduction and survival and over several generations may completely become a new species.

C. GENETIC ISOLATION (post mating isolation mechanisms)

This is where mating between two sub-populations or demes may occur but fertilisation is prevented due to the fundamental differences in the genetic constitution of the different organisms resulting into failure of the male gametes to survive into the female reproductive system e.g. in plants the pollen tube may not grow down to the style to cause fertilisation while in animals the sperms may not survive in the female genitalia.

The fusion of gametes may not take place due to different genetic make-up of the gametes, the production of infertile hybrids (**hybrid sterility**) and the failure of the hybrid to grow and develop up to maturity (**hybrid inviability**).

The organism formed may fail to adapt to the environmental conditions or they may be inferior sterile offsprings. Therefore the two isolated populations (demes) only reproduce successfully by breeding independently within the demes, thereby resulting into the formation of new species.

Genetic isolation may also arise through **reduced hybrid fertility**. In this case, even if hybrids are viable, they may be sterile especially if the chromosomes of the two parent species differ in number or structure, which leads to failure of meiosis in the hybrids, so that they cannot produce normal gametes. Since the infertile hybrids cannot produce offsprings when they mate with either the parental species or between themselves, then genes cannot flow freely between the species.

Genetic isolation may also occur through the following;

- a. Polyploidy
- b. Hybrid breakdown.
- c. Hybrid sterility.

POLYPLOIDY

This is a chromosomal alteration in which the organism possesses more than two complete chromosome sets. It is a result of an accident of cell division.

This brings about hybrid sterility due to the odd number of chromosomes that cause sterility. Even numbered polyploids are fertile and polyploidy therefore divide the population into two groups i.e. one group being

fertile and another group being infertile which is genetically isolated as a result. This restricts breeding in only polyploidy species with even numbered chromosomes.

Polyploidy therefore results into the formation of new species having very good characteristics such as greater resistance to diseases and adverse environmental conditions, high yields, early maturity e.t.c. such characteristics arise mainly due to gene mixing during cross breeding to form the hybrid vigour organisms, especially in plants. Selection for these characteristics in nature leads to the formation of new species.

HYBRID BREAKDOWN

This is a situation where the first generation hybrids (F_1 hybrids) are fertile but later generations (F_2 hybrids) hybrids are infertile.

HYBRID STERILITY

This is a condition where by hybrids fail to produce functional gametes and this leads to genetic isolation of such organisms i.e. it usually occurs when two species mate or flower at different times of the year or when the species have different genetic composition. For example, the formation of the mule ($2n=63$) from the cross between the horse ($2n=60$) and donkey ($2n=66$).

NOTE: In addition to the isolation mechanisms mentioned above, new species may be formed from the following;

- Genetic drift and founder's effect
- Adverse environmental effects like drought
- Drug and pesticide resistance
- Mutations
- Migrations
- Predations

These selection mechanisms may be directional or disruptive.

GENETIC DRIFT AND FOUNDER'S EFFECT

Genetic drift causes speciation in that loss of individuals before reproduction from a small population may lead to loss of an allele from the small population thereby greatly changing the allele frequency of the gene pool e.g. premature accidental death of organisms prior to mating or death of an organism which is the sole possessor of that particular allele would result in the elimination of that allele from the population. It is also possible for an allele to increase to a higher frequency by chance.

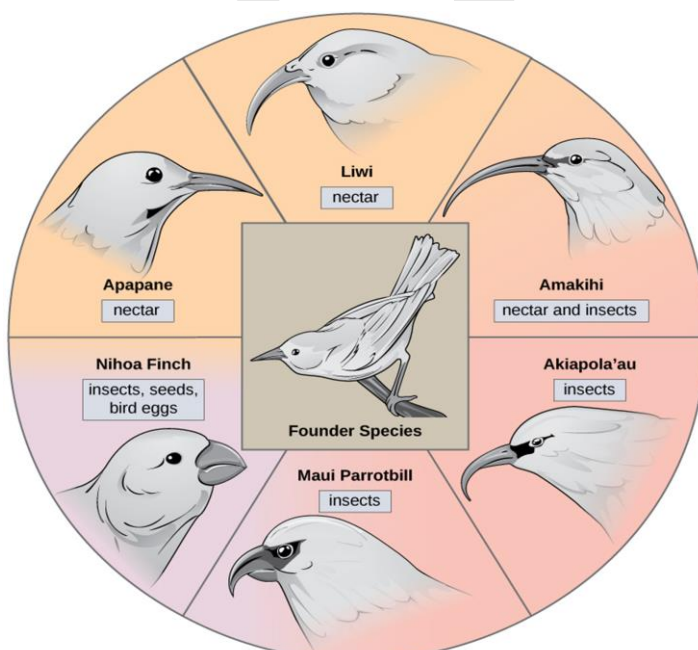

These changes in allele frequency in a small population lead to a divergent population from the parental population that may form new species over several generations.

Genetic drift is not common in large populations because the changes in allele frequency are usually buffered by the large population and so, they become negligible.

Related to genetic drift is a condition known as **founder's effect** or **founder's principle**. This principle refers to one or few individuals of the parental population moving away to another place and then establishing a new small isolated population at some distance away from the original location. The new small population has a gene pool which is not reflective of the original population.

ADVERSE ENVIRONMENTAL EFFECTS

Adverse effects such as floods, bush burning, excessive heat e.t.c. may lead to the formation of new species. The survivors of such an occurrence may be few and their genotypes may not resemble those of the original population. Mutations that may happen as a result of such events leading to speciation. Breeding may also be of closely related homozygous members only, resulting into heterozygotes that may emerge into new species.

MUTATIONS

New species may form through mutations because mutations may bring about a new allele in the population thereby introducing a new variation within the population. If the new variation confers an advantage on the mutants, especially when environmental conditions drastically change, the mutant is favoured to survive and reproduce to increase its numbers. When there is no gene flow between the mutants and the non-mutants, further increase in genetic differences of the two gene pools occurs hence leading to the formation of new species.

MIGRATIONS

These result into the transfer of genes from one population into another. This reduces the size of the gene pools if all the genes are taken away from the population and the demes may eventually become non-identical thereby resulting into the formation of new species. Migrations also encourage the spread of mutant genes in the population hence leading to a change in allele frequency which may lead to the formation of new species.

PREDATION

This forms new species because it puts up a selection pressure of nature among the predators. As the predator population increases the prey population decreases and competition arises among the many predators for the few remaining prey. The well adapted predators to compete for the prey are naturally favoured to survive. While the poorly adapted predators to compete for the prey die or migrate away. The well adapted predators reproduce and pass on their adaptive characteristics to their offsprings. The offsprings eventually undergo adaptive radiation and form new species of the predator.

Selection mechanisms may also favour the formation of new species as they determine alleles to be passed on to the next generation and they also determine the way alleles spread in the gene pool. This may lead to the formation of new species as it results into changes in allele frequency in the new population thereby leading into an evolutionary change that results into speciation.

EXTINCTION OF SPECIES

Extinction is the termination of a genealogical lineage i.e. total disappearance of all organisms of a given species. The term is used most frequently in the context of species, but applicable also to populations and taxa higher than species.

A species may become extinct if it fails to adapt to its environment and as a result it is at a selective disadvantage. This selection pressure can include excessive/massive predation, whereby organisms of a species are preyed upon up to the level where there is no existing member of that kind in the wilderness.

Other selection pressures include the following;

- I. **Lack of the basic nutrients** for the survival of the organisms or elimination of a link in a food chain which cause starvation of the organisms that used to survive on that link. This may seriously affect the availability of the species hence leading to their extinction.
- II. An organism can become extinct through **excessive competition** from development of new species which render the less adapted species extinct due to failure of such species to adapt to the highly competitive environment. As its population declines due to the competition, gene flow from within the species is interrupted hence leading to the extinction.

- III. Species may become extinct due to the **destruction of their habitats** which exposes them to their predators that eventually wipe them out, thereby leading to extinction. This may be due to human activities during exploitation of natural resources, introduction of domestic animals, environmental pollution or direct destruction through hunting.
- IV. It may be due to **climatic changes** which result into the change in the average conditions of the habitat that drastically affect the population hence leading to extinction.
- V. It may be due to **pests and diseases** in that the pathogen micro-organism which attacks the population may kill the organism may kill them in large numbers as these organism fail to develop resistance quickly enough. This may lead to extinction of the species as they may take long to become resistant and even the young ones that would reproduce may be killed before reaching the reproductive stage.
- VI. Other factors include drastic environmental changes such as drought, volcanic eruptions, fire, floods e.t.c. that create new selection pressures such that species which cant adapt die or fail to reproduce

ALLELE/ GENE FREQUENCY

This refers to the total number of individuals in the population baring a particular gene. It can be affected by the following factors in addition to what has already been described;

- a) Closeness of the population
- b) Mutation
- c) Selection
- d) Genetic drift
- e) Migrations

CLOSENESS OF THE POPULATION

This allows free movement between individuals in the population and therefore increases the chances of random mating which results into gene mixing, from which hybrid individuals with altered gene frequencies arise. Two neighbouring populations interact whereby organisms of one population migrate into another population, where it may interbreed. This makes the allele frequency of the donor population to decrease and that of the recipient population to increase due to introduction of new alleles.

MUTATION

Mutations change the allele frequency by bringing about a new allele in the population which can form a basis for natural selection by conferring an advantage onto the mutants, especially when the environment changes, thereby leading to the formation of new species. Mutations can also confer disadvantages to the mutants which decreases the allele frequency as some of the mutants may die or reduce their reproductive potential.

SELECTION

Selection favours certain alleles in the population and eliminates others in a certain environment and in so doing, the alleles increase or decrease respectively. The more favoured individuals with increased reproductive potential are able to pass on their alleles to the next generation while the less favoured individuals usually have decreased reproductive potential which reduces their chances of passing on their alleles to the next generation.

GENETIC DRIFT

This refers to random changes in allele frequency of a small population occurring by chance alone rather than natural selection. In a small population, not all the alleles that represent a gene pool of that species population are present e.g. some may be lost through premature accidental death prior to mating of an organism which happens to be the sole possessor of that allele from the population which will decrease that allele frequency. It affects the amount of genetic variations within very small populations as explained below;

The effect of a few individuals within a small population not contributing their alleles to the next generation can have a great effect on allele frequencies. This is because certain alleles may become lost as the only alleles for the genes present may be eliminated if the individual with the alleles dies.

In a small breeding population, the fluctuations in allele frequency are more severe because random changes in a few alleles cause a greater percentage change in allele frequency i.e. genetic drift occurs.

In a large breeding population, the fluctuations in allele frequency are minimal because the large number buffers the population against the random loss of alleles therefore on average losses for each allele type in a large population will be similar in frequency and therefore little changes occur in such a large population

Variations in genes within a small population can occur by chance rather than by natural selection.

THE HARDY-WEINBERG PRINCIPLE

This states that the frequency of the dominant and recessive alleles in the population remains constant generation after generation as long as environmental conditions do not change i.e. **genetic equilibrium**

However, in nature, this principle is never realised as organisms always vary from each other and therefore adapt differently to the environmental conditions which causes natural selection so that evolution occurs.

This principle is used to determine the gene frequencies in a given population.

CONDITIONS FOR THE HARDY-WEINBERG PRINCIPLE TO BE HELD TRUE

- When the population is large.
- When there are no mutations in the population.
- When mating is random.
- When there is no natural selection
- When there's no genetic drift
- When generations do not overlap.

THE HARDY-WEINBERG EQUATION

This equation is used to determine the genotype and allele frequencies in the population.

If a gene controlling a particular character **A** and **a** with allele frequencies **p** and **q** respectively, then **p + q = 1.0** or **p + q = 100%**.

Where P = frequency of the dominant allele.

Q = frequency of the recessive allele.

In this population, individuals will have the following possible genotypes; **AA, Aa** and **aa** where A is dominant over a.

If heterozygous individuals in the first cross are crossed, the genotypes and frequencies in the F₂ generation will be as follows;

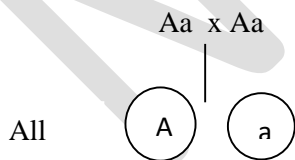

Punnet square to show the fusion of gametes

	A (p)	a (q)
A (p)	AA (p ²)	Aa (pq)
a (q)	Aa (pq)	aa (q ²)

--	--	--

From the Punnet square

- Genotype frequency of homozygous dominant individuals = p².
- Genotype frequency of heterozygote's = 2pq.
- Genotype frequency of recessive individuals = q².

In this population therefore, the total genotype frequency of genes if the heterozygous individuals are selfed is 100% and this is obtained using the hardy-Weinberg equation shown below;

$$p^2 + 2pq + q^2 = 100\% \text{ OR } p^2 + 2pq + q^2 = 1.$$

Example

In a population of 5,000 individuals, 84% of them are non-albinos and 16% are albinos. Using the Hardy Weinberg formula determine the number of individuals who are;

- Heterozygous normal for melanin formation.
- Homozygous normal for melanin formation.
- Albino

SOLUTION

Hardy-Weinberg formula; $p^2 + 2pq + q^2 = 1.0$

Where p = frequency of dominant allele.

q = frequency of recessive allele.

a. Heterozygotes are represented by $2pq$

$$q^2 = 0.16$$

$$q = \sqrt{0.16}$$

$$q = 0.4$$

But $p + q = 1.0$

$$p = 1.0 - q$$

$$p = 1.0 - 0.4$$

$$p = 0.6$$

Therefore $2pq = 2 \times 0.6 \times 0.4 = 0.48$ or 48%

$$\text{Heterozygotes} = \frac{48}{100} \times 5,000 = \underline{2,400 \text{ individuals}}$$

b. Homozygous dominant individuals are represented by P^2

$$p^2 + 2pq + q^2 = 1.0$$

$$p^2 + 0.48 + 0.16 = 1.0$$

$$P^2 = 1.0 - 0.64$$

$$P^2 = 0.36$$

$$= 0.36 \times 100 = 36\%$$

$$\text{Homozygotes} = \frac{36}{100} \times 5,000 = \underline{1,800 \text{ individuals}}$$

c. Albinos

$$= \frac{16}{100} \times 5,000 = \underline{800 \text{ individual}}$$

SAMPLE QUESTIONS

1. (a) What is meant by the term **extinction**? (01 mark)
 b) State **one** natural cause of extinction. (01 mark)
 b) State the ways human activity has accelerated the rate of extinction in present times(03 marks)
 c) Suggest measures that can be put in place to prevent extinction (03 marks)
 d) Explain why large predators e.g. birds of prey are more prone to extinction than herbivorous birds
2. (a) Describe the main features of Neo-Darwinism theory of evolution (10 marks)
 (b) Explain the evidence from the geographical distribution of organisms that supports the theory of evolution described in (a) above. (10 marks)
3. The figure below shows changes in the number of peppered moths in area in which industries were established after 3 years. Peppered moths are expressed as percentage number before and during the industrial revolution.

figure 7

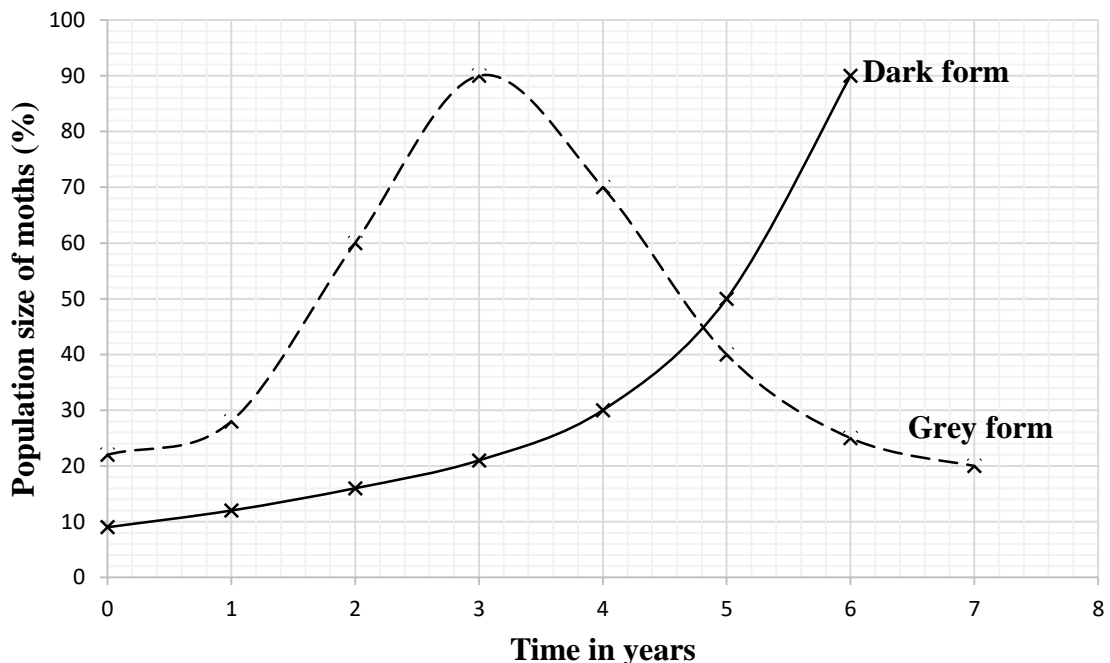

- a) (i) What was the effect of the industries on the number of peppered moths in the area?
 (ii) Explain the effect above? (04 marks)
- b) Three populations of the peppered moths were analysed and the results below were obtained

	Genotypes		
	AA	Aa	aa
Population 1	0.430	0.4810	0.890
Population 2	0.4225	0.4550	0.1225
Population 3	0.0025	0.1970	0.8005

- i. Which of the following populations is in the Hardy-Weinberg equilibrium? (02 marks)
- ii. Determine the frequency of A allele in the population stated above? (02 marks)
4. (a) Explain the modern theory of evolution by natural selection.(10 marks)
 (b) How does each of the following affect gene frequency within a population?
 (i) Non-random mating. (03 marks)
 (ii) Disruptive selection. (03 marks)

(iii) Mutation.

(04 marks)

5. The figure below is a graph that shows the extent of precipitation that occurs when serum from different mammals mixed with sensitized rabbit serum

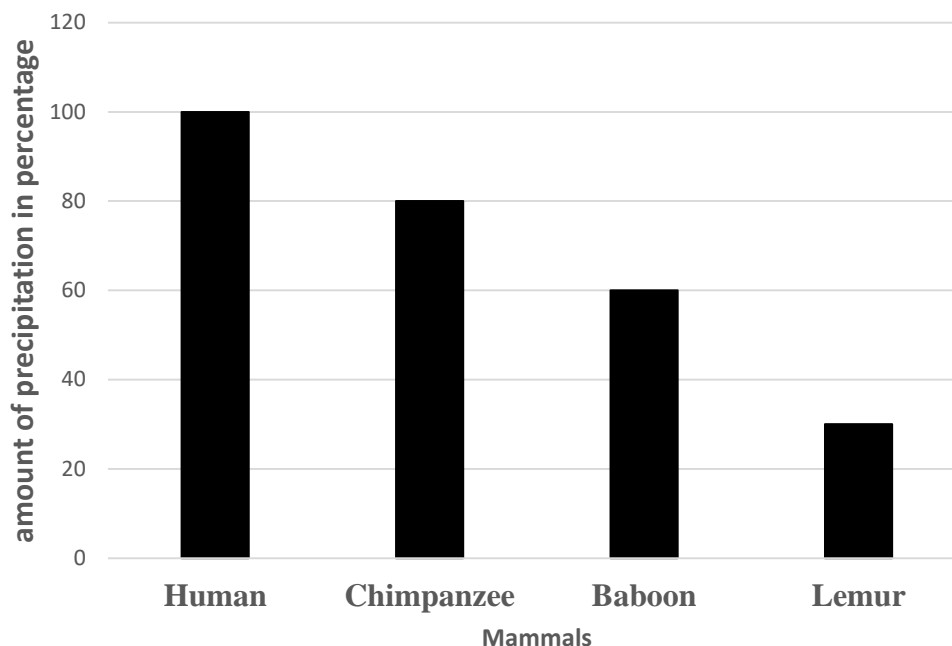

- a) (i) Describe the trend of precipitation of serum from human to lemur (02 marks)
(ii) Explain how precipitates are formed when sensitized rabbit serum is mixed with any mammal's serum (03 marks)
- b) Explain the difference in the amount of precipitate formed between Chimpanzee and Lemur.
- c) State **one** evolutionary conclusion about the relationship between human beings and
- Chimpanzee (01 mark)
 - Lemur (01 mark)
6. The table below shows the amount of antibiotics used (in kilograms) in treating bacterial diseases and the percentage of bacterial strains which have become resistant to the antibiotics used in one of the hospitals in Uganda over twenty years.
- | Time /years | 2 | 4 | 6 | 8 | 10 | 12 | 14 | 16 | 18 | 20 |
|---|-----|-----|-----|-----|-----|-----|-----|-----|-----|-----|
| Amount of antibiotics/Kg | 0.5 | 2.5 | 6.4 | 3.0 | 3.7 | 3.1 | 2.8 | 0.5 | 0.8 | 0.5 |
| % of bacterial strains resistant to antibiotics | 3 | 4 | 2 | 18 | 22 | 15 | 17 | 5 | 5 | 4 |
- a) (i) By using appropriate scales, represent the above data graphically
(ii) Describe how the resistance of the bacteria varied with the amount of antibiotics administered
- b) Briefly explain how each of the following could have contributed to the rapid emergence of resistant strains;
- DNA in a bacterium is haploid
 - Bacteria usually reproduce asexually by fission
 - Fission may take place as often as every 30 minutes
- c) The graph may be used to demonstrate evolution in action. Explain fully how
7. A factory emitting smog containing sulphur dioxide and carbon dioxide was cited in a rural district. The table below gives distance and directions of :
- Number of moths and
 - Concentration of sulphur dioxide in smog in different directions from the factory chimney

Table 1

Distance from factory in a south-south West direction (miles)	1	2	4	8	12	16	28
Number of moths species	0	1	2	3	7	9	12
Sulphur dioxide concentration/parts per million	28	27	26	23	19.5	16	2

Table 2

Distance from factory in a north north east direction (miles)	1	2	4	8	12	16	28
Number of moths species	1	2	3	4	4	5	5
Sulphur dioxide concentration/parts per million	27	26.5	25	24	23	22	19

- a) Plot the information to show the relationship between the moth species distribution and the sulphur dioxide concentration the same X-axis and Y-axis. (12 marks)
- b) Explain the difference in results between obtained for the south-south west direction and those obtained for the north-north east direction (02 marks)
- c) Fully explain why the number of moths increase with increasing distance from the factory (04)
- d) The results obtained give evidence of present day evolution. Explain fully this evidence and its significance in evolution (10 marks)
- e) What are the environment effects of sulphur dioxide and carbon dioxide? (08 marks)
8. (a) Give the characteristics of predator-prey interactions in nature (05 marks)
- (b) In what ways do the predator-prey interactions compare with parasite-host interactions (07 m)
- (c) Explain how predator-prey interactions influence the formation of a new species (08)
9. (a) What is meant by gene reshuffling (04 marks)
- (b) Explain how;
- Reshuffling of genes may contribute to genetic variation (06 marks)
 - Interactions at the gene locus affect phenotypic variation (10 marks)
10. (a) Describe the structural evidence of evolution in animals (10marks)
- (b) Explain the role of the following in evolution.
- Non-random mating (5marks)
 - Gene flow (5marks)
11. a) Describe the evidence of evolution based on palaeontology? (09marks)
- b) Explain how the following may lead to evolution of a new species;
- selective breeding (05marks)
 - increased population size (06marks)
12. a). Differentiate between discontinuous and continuous variation. [05marks]
- b). What is the role of each of the following in evolution?
- Meiosis. [05marks]
 - Mutation. [05marks]
- c). How does biogeography show that evolution occurs? [05marks]
13. (a) Describe how Darwin explains evolution of a new species by natural selection. (10)
- (b) Explain how the following may lead to evolution of a new species.
- Selective breeding. (05 marks)
 - Increased population size. (05 marks)
14. (a) Explain the main features of Darwin's theory of evolution. (12 marks)
- (b) The beetles belonging to the *genus Colophon* are unable to fly and are found on hilltops in three areas in South Africa. Suggest an evolutionary explanation for each of the following statements.
- All of these beetles are of very similar general appearance. (02 marks)
 - There are slight differences between the species of *Colophon* found in the three areas.
 - The fact that the beetles of the *genus Colophon* are unable to fly has been important in the evolution of twelve different species of the genus in a small area of South Africa. (03 marks)
15. (a) Explain the various forms of isolating mechanisms
- (b) Describe the factors that lead to species extinction
16. a) Define the following terms:-
- A deme (03 marks)
 - Genetic equilibrium (02 marks)

- iii. Reproductive isolation (03 marks)
- b) Describe how genetic equilibrium can be upset in a deme/population. (07 marks)
- c) Given an account of how reproductive isolation is brought about in a population (05 marks)
17. (a) What is variation? (02 marks)
- b) Giving examples, explain the various ways in which variation may arise (12 marks)
- c) What is the role of natural selection in the evolution of organisms making a population 06 m
18. (a) Explain the significance of the following in evolutionary study
- i. Comparative anatomy (07 marks)
- ii. Comparative serology (03 marks)
- (b) How does the concept of development and distribution of Darwin's finches at the Galapagos Islands explain evolution? (10 marks)
19. (a) What is meant by the following as it relates to the survival of living organism?
- i. Adaptation (03 marks)
- ii. Selection pressure (03 marks)
- (b) Explain how the following are considered to be selection pressures
- i. Insecticides (07 marks)
- ii. Artificial selection (07 marks)
20. (a) Explain how industrial melanism shows that evolution occurs (10 marks)
- (b) How does Meiosis bring about variation in organisms? (10 marks)
21. (a). Describe the contribution of meiosis towards variation. [5mks]
- (b). Describe the role played by the following in the formation of new species.
- (i). Polyploidy. [7mks]
- (ii). Artificial selection. [4mks]
- (iii). Genetic drift. [4mks]
22. a) How does Darwin's theory of evolution explain the existence of Finches in the Galapagos Islands?
- b) Explain how industrial melanism and use of insecticides prove that evolution occurs
23. (a) Discuss the various forms of isolating mechanisms
- (b) Distinguish between stable and unstable polymorphism
24. (a) What is meant by the term **genetic equilibrium**? (02 marks)
- (b) Suggest **three** reasons why populations in genetic equilibrium fail to undergo evolution (03 marks)
- (c) State **two** instances where the evolution of one species has been influenced by evolution of another
- (d) Explain how extinction of species is an important aspect of speciation (03 marks)
25. (a) Describe the different evidence for the occurrence of organic evolution (10 marks)
- b) Explain how gene reshuffling brings about speciation (10 marks)

END

TOPIC 9: ECOLOGY

SYLLABUS EXTRACT

Specific objectives; The learner should be able to:	Content
<p>1.1 Components of environment</p> <ul style="list-style-type: none"> Describe the abiotic and biotic components and factors. Explain how the components and environmental factors influence the distribution and abundance of organisms in an ecosystem. 	<ul style="list-style-type: none"> A biotic components: air, water, soil and factor: light, temperature, humidity atmospheric pressure rainfall, edaphic factors (PH, moisture) and biotic components living things and factors: Competition, predation biological associations. Influence of a biotic and biotic components and factors of the environment on distribution and abundance of organisms.
<ul style="list-style-type: none"> Collect data from field studies Analyses and interpret data or literature on ecological principles 	<ul style="list-style-type: none"> Data ecological components and factors of an ecosystem. Data or literature on ecological principles
<p>4.1 Concept of ecosystem</p> <ul style="list-style-type: none"> Describe an ecosystem State the type and properties of an ecosystem. Explain changes in an ecosystem Describe feeding relations in an ecosystem. Explain energy flow and recycling of nutrients in an ecosystem. Describe biogeochemical cycles. 	<ul style="list-style-type: none"> The ecosystem defining types quarter time limit proper Types and properties of an ecosystem: aquatic and terrestrial ecosystems. Ecological factors influencing the life of organisms in an ecosystem: abiotic, biotic, and edaphic. Changes in an ecosystem (ecosystem productivity succession and climax). Feeding relations: Food chains, food webs, recycling of nutrients and energy flow in ecosystems. Biogeochemical cycles (nitrogen, Carbon, water).
<p>1.3 Population and natural resources</p> <ul style="list-style-type: none"> State population density Describe methods or techniques of estimating population Explain population growth patterns Explain the terms renewable and non-renewable resources. Discuss environmental resistance and “balance of nature”. 	<ul style="list-style-type: none"> Population characteristic: density, age structure, sex growth pattern, birth rate, death rate. Population density dependent factors and density independent factors. Method or techniques of measuring and estimating Population growth patterns Natural resources: type renewable and non-renewable Environment resistance: density dependent factors affecting “ balance of nature”
<p>1.4 Population and natural resources practical</p> <ul style="list-style-type: none"> Demonstrate the methods used in estimating populations 	<ul style="list-style-type: none"> Methods of estimating population: quadrant, line transect, capture – recapture.
<p>1.5 Interdependence</p> <ul style="list-style-type: none"> Explain the various interactions of organisms in nature. 	<ul style="list-style-type: none"> Interactions among organisms and their effects interspecific and intraspecific relationships between organisms

<ul style="list-style-type: none"> • State the significance of organisms' interactions in nature. 	<ul style="list-style-type: none"> • (Competition, Parasitism, predation saprophytes, Mutualism) commensalism.
4.6 Effects of human activities on ecosystem	
<ul style="list-style-type: none"> • Discuss the impact of human activities on an ecosystem. • Explain the influence and effects of human activities on ecological components and factors in a habitat. • Discuss natural resources utilization 	<ul style="list-style-type: none"> • Significance of organism interactions nature. • Impact of human activities on an ecosystem • Effects of human activities on ecosystem components and factors in a habitat interruption of biogeochemical cycles, natural resources imbalances, population imbalances soil erosion, soil exhaustion, extinction, pollution speciation • Natural resources utilization and sustainable development. • Natural resource conservation practices: mulching, terracing, crop rotation afforestation. Mixed farming agro forestry, wise use of resource organic manure. • Natural resource utilization and sustainable development.

Introduction

Ecology is the scientific study of the relationship between living organisms and the environment or surrounding. The living organisms are the flora (plants) and fauna (animals). Ecology lays a foundation for the understanding agriculture, forestry, fisheries, conservation, impact of human activities on the ecosystem and how to remedy these impacts.

Ecological studies can be directly towards a particular organism or a single species, communities or an ecosystem. The word ecology originates from a Greek word ‘oikos’ meaning a home. Two types of ecological studies namely **autecology** and **synecology** are commonly carried out.

Autecology is the study of the relationship between a single species and the environment in relation to its environment.

Synecology is the study of the relationship between natural communities or different populations of organisms in a given environment i.e. the study of the relationship between all plants and animals in a particular area to the environment.

Description of ecological terms

<p>Ecosystem An ecosystem refers to the interaction between living organisms and non-living components of the environment or habitat to form a <u>natural self-supporting system</u> e.g. in a pond or aquatic ecosystem. It consists of phytoplanktons, saprophytes, zooplanktons as the biotic component (living) whose interaction with dead decaying organic matter or recycle for self-sustainability.</p>	<p>Species A group of organisms showing resemblance among themselves in appearance, behaviour, chemistry and genetic makeup for sexually reproducing organisms, individuals are capable of interbreeding to produce fertile off springs Native species Species that normally survive and thrive in a particular ecosystem Non-native/alien/exotic species Species that migrate into the ecosystem or are deliberately or accidentally introduced into an ecosystem by humans e.g. crops and game species Indicator species Species that serve as early warnings of damage to a community or an ecosystem Keystone species Species that play more important roles than others in maintaining the structure and function of ecosystems of which they are a part i.e. it is a dominant species that dictates community structure by affecting abundances of other species. E.g. elephants uproot and break trees, creating forest openings in the savanna grasslands and woodlands, which promotes growth of grasses for grazers and also accelerates nutrient recycling. Note: all species play some role in their ecosystems and thus are important, therefore the assertion that some species are more important than others remains controversial</p>
<p>Habitat This is a place or physical area where the organism or species lives in an ecosystem.</p>	
<p>Microhabitat Small locality within the habitat with particular conditions (microclimate) that support specific organisms e.g. mosses can grow at the upper side of a fallen log, forests have more micro-habitats e.g. upper and lower leaf surfaces</p>	
<p>Population This is a group of organisms or individuals of the same species which occupy a particular area or habitat at the same point and time e.g. toads in a pond</p>	
<p>Community. This refers to all populations that occupy a well-defined area at a given time. This implies that all plants, animals and fungi in a particular area form a community therefore a community is a group of plants and animals of different species living together in a certain environment i.e. plant and animal community.</p>	
<p>Biosphere This is part of the earth inhabited by living organisms. The biosphere comprises of terrestrial and aquatic ecosystem. The biosphere is subdivided into bio-geographical regions each inhabited by destructive species of plants and animals that are favored by unique conditions of such areas. Bio-geographical regions are also subdivided into particular areas called ‘biomass/biomes’.</p>	
<p>Biome refers to a large recognizable community formed as a result of interaction between regional climates with</p>	<p>Niche /Ecological niche The role an organism plays in the habitat, and its interactions with other organisms i.e. the sum of all environmental factors that influence the growth, survival and reproduction of a species. A niche is like the “profession” of an organism</p>

<p>regional/biotic e.g. tropical rain forests, tropical savanna, desert, temperate region. The biome is divided into zones e.g. forests biome forms the ground level and canopy. The lake forms the limnetic zone, littoral zone, benthos and profundal zone, each zone supporting a particular type of organisms.</p>	<p>Fundamental niche The physical conditions under which a species might live, in the absence of interactions with other species</p> <p>Realised niche The role an organism plays in the habitat, and its interactions with other organisms in the presence of competition and other constraining factors i.e. is the set of conditions under which an organism exists in nature.</p>
<p>Ecotones are boundary zone between two biomes or ecosystem where one merges into the other.</p>	

1.0 COMPONENTS OF THE ENVIRONMENT (structure of the ecosystem)

It consists of:

<p>Biotic component: These are the components which interact between the different living organisms e.g. competition, predation, symbiosis. Also they are called density dependent factors. The biotic part includes producers, primary consumers (first level carnivores), tertiary consumers (higher carnivores), decomposers & detritivores, e.t.c.</p>	<p>Abiotic factors (density independent factors) These are factors affecting the population regardless of the number of individuals within e.g. temperature changes, natural catastrophes like floods, storms, volcanicity, fire, earth quake, drought, etc.</p> <p>Edaphic factors The soil directly influences plant growth and indirectly the animal population e.g. soil texture, soil pH, air, humus, salts, water, etc.</p> <p>Climatic factors (density dependent) They include light, water/rain fall, wind/air, relative humidity, temperature</p>
---	--

THE PHYSICAL ENVIRONMENT

The conditions in which organisms live i.e. physical (abiotic) environment and biotic environment, determine the distribution of the organism. The abiotic environment embraces everything that is not associated directly with the presence of other organisms.

<p>(i) Temperature. Enzymes work within a narrow range of temperature. Organisms have physiological and / or behavioural adaptations to avoid extremes of environmental temperature.</p> <p>(ii) Light. This is essential for all green plants and photosynthetic bacteria, and for all animals dependent on plants.</p>	<p>(iii) Water. The need for water depends on its requirement and the animal's ability to conserve water in adverse conditions.</p> <p>(iv) Humidity. Humidity affects the rate of water loss from the surface of an organism, which in turn influences its ability to withstand drought.</p>
<p>(v) Wind and air currents. Wind is instrumental in dispersal of seeds and fruits. Only plants with strong root systems and tough stems can live in exposed areas.</p>	
<p>Edaphic factors are as a result of the climate and they also have an influence on the distribution of organisms</p>	
<p>(vi) pH. Most plants are highly sensitive to changes in pH and their distribution in soil and fresh water ponds depends on the pH.</p> <p>(vii) Mineral salts and trace elements. This affects plant distribution in soil and plants that can survive in soil deficient in a given mineral have special methods of obtaining that mineral. These methods include carnivorous habits and harboring of nitrogen-fixing bacteria</p> <p>(viii) Salinity. Influences the distribution of estuarine animals, fresh water animals and marine animals.</p> <p>(ix) Background. Animals which depend on camouflage for survival will be influenced by the appearances of the background e.g. black and white peppered moth.</p>	<p>(x) Water currents, in streams and rivers. Animals which cannot actively swim live under stones or in burrows and crevices in the bank.</p> <p>(xi) Wave action. Animals that live in the intertidal zone have special adaptations e.g. sessile habit of animals like sea anemones, burrowing by shrimps and sand hoppers, and firm attachment to rocks and general toughness of sea weeds e.g. <i>Fucus</i>.</p> <p>(xii) Topography leads to differences in illumination, temperature and moisture all of which influences the distribution of animals and plants.</p>

How biotic factors affect the distribution and abundance of organisms

Of all living organisms, humans exert most influence on the distribution and survival of other species through a multitude of activities like pollution, deforestation, farming, construction, e.t.c.

Other factors which affect the distribution and abundance of organisms include:

- a) **Predation.** In predation, members of one species (the predator) feed on all or part of a living organism of another species (the prey). Therefore, predators are only found where there is prey e.g. herbivores are found where there is suitable plant material, carnivorous plants where there is suitable insects, predators where there is suitable prey
- b) **Competition.**
Intraspecific competition is the competition between members of the same species for the same resources, while **Interspecific competition** is the competition between members of two or more different species for food, space, good hiding place, water, sunlight, nesting sites or any other limited resource.

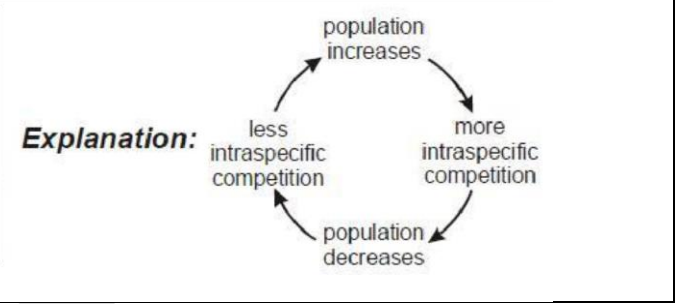
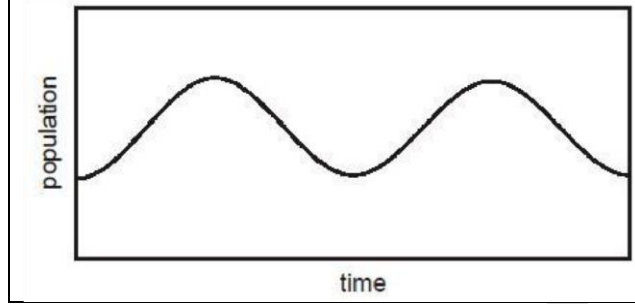
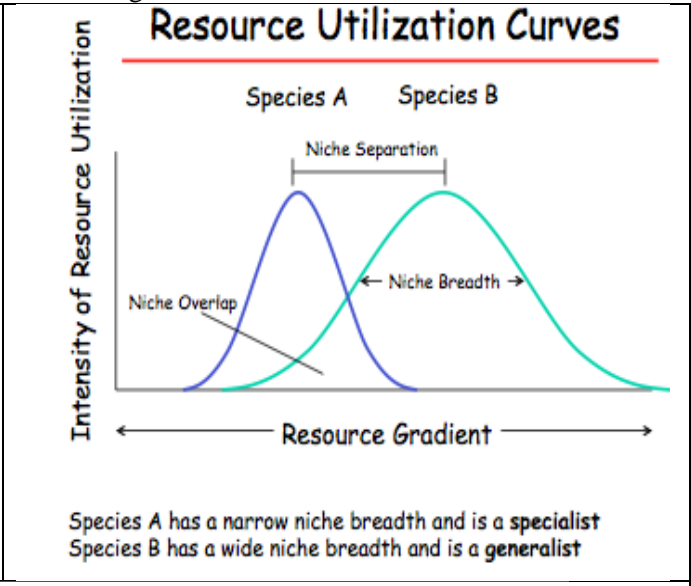

Competition is very intense when there is significant *overlap of niches*, and in this case, one of the competing species must (i) migrate to another area if possible (ii) shift its feeding habits or behaviour through natural selection and evolution (iii) suffer a sharp population decline or (iv) become extinct in that area, otherwise two species can never occupy exactly the same ecological niche i.e. the Gaussian competitive exclusion principle

- c) In instances where one organism uses another as host, their distribution is related e.g. in **parasitism** one species (parasite) lives on or in another organism (host), in mutualism two species interact in ways that benefit both e.g. nitrogen fixing bacteria and legumes, in commensalism one species neither harms nor helps the other species much it interacts with e.g. There is no harm caused to large trees when epiphytic plants like orchids attach on the branches to get support and be elevated to access sunlight and water vapour in air.
- d) The **pollination and dispersal** relationship between flowering plants and animals such as insects, birds and bats may be highly elaborate and species-specific. This Co-evolution ensures that the distribution of the plants and their pollinators or agents of dispersal is related e.g. arum lily flower is pollinated by dung flies.

What is Co-evolution?
 This is the long term evolutionary adjustment of two or more groups or organisms that facilitate those organisms living with one another.
 Examples:

- i) Many features of flowering plants have evolved in relation to the dispersal of the plant's gametes by animals, especially insects. The animals have in turn evolved a number of special traits that enable them to obtain nectar.
- ii) Grasses have evolved the ability to deposit silica in their leaves and stems to reduce their risks of being grazed. In turn, large herbivores have evolved complex molars with enamel ridges for grinding up grass.

- e) Some species gain protection to avoid predation by **mimicking** (looking and acting like) other species that are distasteful to the predator. This ensures that the distribution of the mimic and mimicked species is related e.g. the non-poisonous viceroy butterfly mimics the poisonous monarch butterfly.
- f) In the course of evolution preyed upon species have evolved **deceptive looks** to avoid predation e.g. span worms have shapes that look like twigs, some insect pupae may look like tree thorns. Therefore such animals are distributed where there are plants that ensure their survival.(Roberts pg 524 fig 32.5)
- g) **Antibiosis**. This is the secretion of chemicals, by organisms, that may be repellent to members of the same species or different species e.g. penicillium (a fungus) secretes antibiotics that inhibit bacterial growth, ants release pheromones to warn off other members of a species in case of danger.

Fire as an ecological factor

Factors that control the effectiveness of fire

i) Kind and amount of fuel:

Tall grasses produce much fire more than heavily grazed areas. However, forest fires are more vigorous than grass fires and they cause much more destruction. This is due to the amount of fuel that takes time to be completely burned.

iii) Topography:

Fires are fastest uphill and slowest downhill therefore the effect of fire on soil is greatest on fires downhill rather than uphill.

v) Direction of fire:

Back fire burning against the wind direction is more severe on the soil than forward fire burning with the wind direction.

ii) Weather conditions:

During the rainy season fires do not spread very far and become wild but in a dry season fires are more wild, strong and destructive e.g the Australia fires

iv) Frequency of burning:

Continued burning has a more permanent destructive effect. It does not only destroy vegetation cover but kills soil and fauna.

Advantages of fires	Disadvantages of fire
<ul style="list-style-type: none"> ❖ It breaks seed dormancy due to hard seed coat leading to fast germination. ❖ It increases recycling of nutrients in an ecosystem. ❖ It is used in selective weeding. ❖ It controls pests and diseases. ❖ It improves on herbage (pasture, herbs) in an area. ❖ It improves on light penetration leading to rapid under growth in the forest. ❖ It improves on the visibility of the prey to predators by burning the vegetation cover down. 	<ul style="list-style-type: none"> ❖ It destroys the habitat of animals which may cause extinction of some animals. ❖ It causes air pollution ❖ It destroys green plants which are producers of the community. ❖ It destroys animals in the ecosystem. ❖ It increases predation due to improved visibility. ❖ It leads to loss of some nutrients from the soil by decomposition e.g. humus and nitrates.

2.0 CONCEPT OF THE ECOSYSTEM

An ecosystem is a natural system consisting of ecological communities of living organisms (biological communities) interacting with the abiotic (non-living) components of the environment to form a stable and equilibrium system which is self-sustaining.

The dynamics of an ecosystem can be disturbed if there are changes in the biotic or/and abiotic environment. Examples of ecosystems are the pond, lake, ocean, grassland and tropical rainforest.

Functions taking place in the ecosystem

- Recycling of matter i.e. nitrogen cycle, carbon cycle, e.t.c.
- Energy flow/transfer from producers, consumers and decomposers.
- Food interactions/food chain and water.

- Population control/dynamics/cybernetic of the population.
- Succession.
- Development and evolution of species of organisms (death due to competition and resistance due to competition/survival for the fittest).

Types of ecosystems

There are two major types of ecosystem, namely;

1. Terrestrial/land ecosystem
2. Aquatic ecosystem

Each of the two can further be grouped into several habitats.

Aquatic ecosystems

Aquatic ecosystems support a great diversity of life forms. Water occupies 50% of the earth's surface. Water provides a more constant and protective environment than land (desiccation, less affected by sudden and drastic changes in physical and chemical conditions, some change due to climatic or seasonal variation). It provides support and dissolved oxygen and nutrients to aquatic organisms.

Aquatic ecosystems are classified as the following depending on the concentration of salts they contain;

- ❖ Fresh water ecosystem
- ❖ Marine ecosystems
- ❖ Estuarine ecosystem

Fresh water ecosystem

Fresh water habitats occupy a small portion of the earth's surface as compared to marine and terrestrial habitats. However, fresh water habitats are of great importance to man for the following reasons:

- ❖ Cheapest source of water for domestic and industrial use
- ❖ Provide the cheapest waste disposal systems
- ❖ Harbour various animals

Fresh water habitats can be classified into:

- 1) Lotic (running water bodies) e.g. rivers and streams
- 2) Lentic (standing water bodies) e.g. pond, lake and swamps

Structure of a lake/pond (Lake Zonation)

The lake environment (lake zonation) is generally classified on the basis of three physical criteria: light penetration (photic and aphotic zones), distance from shore and water depth (littoral and limnetic zones), and whether it is open water (pelagic zone) or bottom (benthic zone).

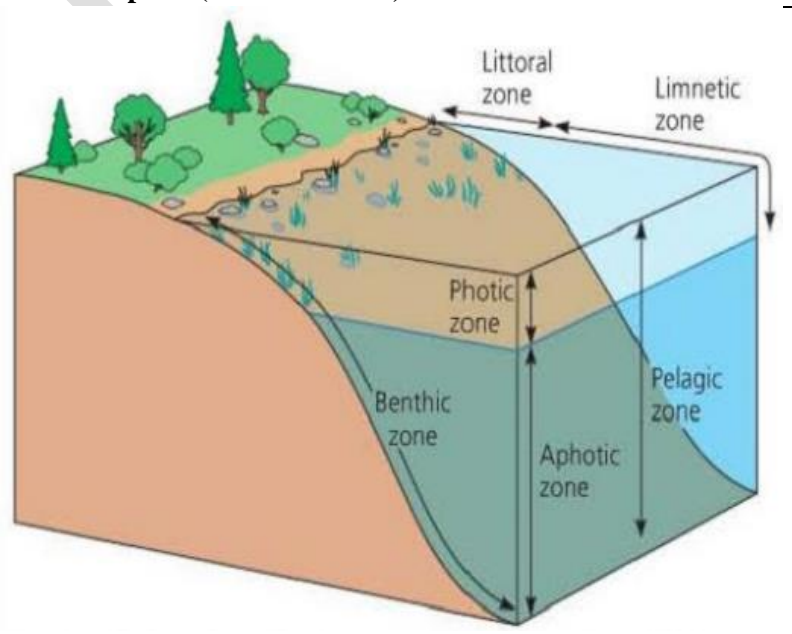
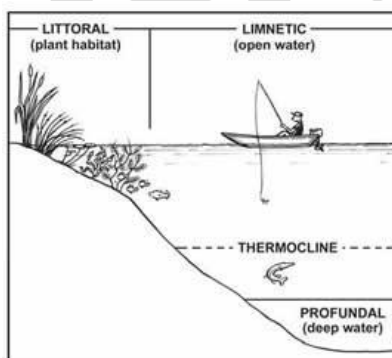

- i) **Littoral zone:** shallow water region with high light penetration. It has the highest productivity due to high carbon dioxide/oxygen and suitable temperatures.
- ii) **Limnetic zone:** it's the open water zone to the depth of effective light penetration. The community here includes phytoplankton, floating insects and algae. Like littoral zone, productivity/net productivity is

highest because of high effective light penetration, more dissolved gases, high temperatures at the surface and turbulence due to the high air content/wind so high photosynthesis. Dissolved nitrogen is fixed by nitrogen fixing bacteria and blue-green algae to make proteins. Dissolved carbon dioxide formed carbonic acid which results in formation of H^+ , HCO_3^- and CO_3^{2-} .

- iii) **Profundal zone:** receives little or no light. Light penetration decreases with depth and also net productivity decreases with depth.
- iv) **Benthic zone:** this is the bottom most, receives no light at all, no dissolved gases, aerobic bacteria exists so little productivity. The productivity is due to water currents which tend to mix the upper layers with bottom layer and photosynthesis and chemosynthesis bacteria exist.

Ecological classification of fresh water organisms

<p>Organisms in water can be classified depending on their life form which is based on their mode of life. The following terms are used:</p> <p>1. Neuston: These are organisms resting or swimming on the surface of water. Such organisms may be supported by the surface film or cling to the surface film from beneath or swim in the upper waters. Examples include pond skaters, air breathing diving beetles, water boat men, floating plants like duck weed, bladder work, e.t.c.</p> <p>2. Plankton (floating): This is a mass of floating small plants (phytoplankton) and animals (zooplankton) whose movements and distribution are more or less dependent on currents. Their powers of locomotion are restricted to small vertical movements or to catching prey. Examples include arolia, Pistoia, water burg, tadpole, e.t.c.</p> <p>3. Nekton: These are free-swimming organisms that can swim against water currents. Some of them are small e.g. swimming insects while others are large e.g. bony fish, amphibians, e.t.c.</p> <p>4. Benthos: These are organisms attached or resting on the bottom or living in the bottom sediments. Most of them feed on fresh water organisms in ponds and lakes. They may also be classified depending on the sub habitat they occupy.</p>	<p>Three zones are generally evident (refer to the figure on page 8);</p> <p>i) Littoral zone: This is the shallow-water region with light penetration to the bottom. Such a zone is typically occupied by plants in natural ponds and lakes.</p> <p>ii) Limnetic zone: This is the open water zone to the depth of effective light penetration. The community in this zone is composed of plankton, nekton and sometimes Neuston. In shallow ponds, this zone is absent. The total illuminated depth including the littoral and limnetic zone is referred to as the euphotic zone.</p> <p>iii) Profundal: This is the bottom and deep water area which is beyond the depth of effective light penetration. This zone is often absent in ponds.</p>
---	---

Factors affecting productivity of the lake

- ❖ Temperature
- ❖ Nutrient availability
- ❖ Salinity
- ❖ Water current
- ❖ Pollution

Warm temperature provide optimum medium for aquatic organisms distribution as well as enzymes involved in photosynthesis.

Cool temperature of bottom water inactivate enzyme and affect distribution of phytoplankton thus reduced productivity.

Availability of nutrients in water due to decomposition of organic matter like sewage, dead organisms and fertilizers washed off from farm and water would lead to algal blooming or eutrophication of phytoplanktons. This would instead increase productivity since phytoplanktons are many.

Man’s activities that harm the environment. With the recent increase in the human population, there has been over exploitation of natural resources.

Limiting factors in fresh water ecosystems

Limiting factors restrict the distribution of living organisms hence preventing the colonization of otherwise favourable environment. The most important limiting factors in fresh waters are:

1. Temperature:

Water has several unique thermal properties. Although temperature is less variable, it is a major limiting factor. Aquatic organisms have narrow tolerance. Temperature changes produce characteristic patterns of circulation which greatly influence aquatic life.

2. Light penetration:

Penetration of light is often limited by suspended materials (turbidity). This restricts the photosynthesis zone. Plants cannot survive below the compensation level. Light penetration can be measured using a *Secchi disc*. It consists of a white disc that is lowered from the surface until it just disappears from view. This ranges to about 40 cm in very clear waters.

3. Water currents:

Currents determine the distribution of vital gases, salts and small organisms. Water current is a limiting factor in fast flowing streams and on shores when it prevents colonization by weak swimming organisms.

4. Dissolved gasses:

Gases from the atmosphere dissolve in water at the surface. However, some gases are more soluble than the others. E.g. oxygen is 30 times less abundant in water than in air.

This limits the distribution of living organisms. The diffusion of dissolved gases through deep layers of water is very slow. In some places currents and wave action aid the diffusion, but in still waters, very little oxygen is transferred to lower levels. Once the little oxygen available is used up by decomposers, the effects may be disastrous to the whole community.

Dissolved nitrogen is used by nitrogen fixing bacteria and blue-green algae in the manufacture of proteins. Effects of carbon dioxide are complex due to the formation of carbonic acid to form $H^+ HCO_3^-$ and CO_3^{2-} ions. These combine with other dissolved substances in the water.

5. Dissolved salts:

Fresh water ecosystems show a considerable variation in salt content. This depends on the minerals present in drainage water from the surrounding land mass and activities of living organisms. Deposition of nutrients in water is known as eutrophication.

Nitrate and phosphate are the most limiting factors in fresh water ecosystems e.g. phosphorous is a limiting factor because the ratio of P to other elements in organisms is greater than the ratio in the primary sources of the biological elements. K, Ca, S and Mg may also act as limiting factors.

Biological classification of lakes

Biological classification of lake ecosystems depends on the circulation rates of inorganic plant nutrients in the lake. Three major types are recognized:

1. Eutrophic lakes:

These are with waters relatively rich in plant nutrients.

Characteristics

- ❖ Have high surface area to volume ratio hence easy circulation
- ❖ They are relatively shallow with gentle sloping banks which can support wide belts of marginal vegetation (wide littoral zone).
- ❖ Have relatively high phosphates and nitrates, i.e. they are very productive.
- ❖ Due to emergent and submerged plants plus a lot of phytoplanktons, upper layers are rich in oxygen. The bottom layers are low in oxygen concentration since it is continuously being used for bacterial decomposition e.g. Lake Kyoga.

2. Oligotrophic lakes:

These are with low plant nutrients and they are highly oxygenated.

Characteristics

- ❖ They have low surface area to volume ratio, hence limited circulation.
- ❖ They are deep with steep rock sides.
- ❖ Waters are low in plant nutrient but highly oxygenated.
- ❖ Neither have extensive marginal vegetation nor organic bottom deposits which results in their low productivity e.g. Lake Tanganyika.

3. Dystrophic lakes

These have brown water where the bottom deposits of such lakes consist of unrotten organic matter which accumulates as heat. Productivity of such lakes is very low.

The pond ecosystem

The pond ecosystem is complex and is affected by several environmental conditions. The living organism and the nonliving environment are inseparable and the following can be recognized:

i) Abiotic substances:

These include basic inorganic and organic compounds e.g. water, CO₂, O₂, Ca, N, P, soil, etc. A small portion of the vital nutrients is in soil and available to organisms but much larger portion is held in the bottom sediments and in the organisms themselves. The rate of release of nutrients from the solids, solar input and other environmental factors determine the productivity of the entire ecosystem.

ii) Producer organisms:

There are two major types only; Rooted or large floating plants growing in shallow water e.g. papyrus and Phytoplankton distributed throughout the pond as deep as limnetic zone.

Note: in deep ponds and lakes, phytoplankton is much more important than rooted vegetable in the production of the basic food from the ecosystem (algal blooms)

iii) Macro organisms:

These include animals like insect larvae, crustacea, fish, etc. primary consumers feed on plants or plant remains e.g. zooplankton and benthos (molluscs).

Secondary consumers e.g. predaceous insects and fish feed on primary or secondary consumers.

Detritivores e.g. worms, larvae and rotifers consume organic matter from upper layers.

iv) Saprotrophic organisms:

Aquatic bacteria, flagellates and fungi are distributed throughout the ponds, but are abundant at the bottom where plant and animal organic matter accumulates.

Dead organisms are rapidly broken down by detritus feeding organisms and microorganisms and their nutrients are released for re-use.

How thermal stratification occurs in lakes

In warm weather the surface of a lake is heated by the sun. The warmed surface becomes less dense, and so remains at the surface, floating on the colder water beneath. The surface continues to gain heat from the sun, while the bottom water remains cold. If this surface heating continues for some days, without storm winds to stir the lake, a marked temperature difference can develop between the top and bottom water and the following compartments are recognised:

- a) **Epilimnion:** upper warmer water, usually well oxygenated.
- b) **Metalimnion** (thermocline): middle portion between Epilimnion and Hypolimnion where the rate of temperature change with depth is rapid.
- c) **Hypolimnion:** the deepest portion, with denser and cooler water, usually with low oxygen concentration.

Seasonal changes that occur in temperate lake

Winter	Late spring/early summer	Late summer	Autumn
During the winter, water is evenly mixed and tends to have the same temperature and chemical composition at all depths.	In the spring, sunshine and warm air temperature melt the ice cover and bring the upper layers of the lake to the same temperature as the lower, about 4°C, enabling strong winds to mix the waters of the lake completely (spring overturn)	There is maximum thickness of epilimnion and maximum temperature difference between epilimnion and hypolimnion.	As the lake surface cools by evaporation, convection and radiation, the stability of the stratified system reduces.

If the lake freezes, ice of 0°C floats over warmer water of 4°C.	The lake stratifies with a warm epilimnion floating over a cold hypolimnion and a thermocline between.	Epilimnion may be depleted of nutrients and Hypolimnion may be depleted of oxygen.	Strong winds mix the lake water (fall overturn), causing uniform temperatures and chemical composition throughout the water column
The nutrient and oxygen concentrations of the water are high, but oxygen can be depleted under ice in shallow lakes	Phytoplankton bloom in the surface water. Nutrient concentrations begin to fall in the epilimnion and oxygen concentrations begin to fall in the hypolimnion.	In very fertile lakes the hypolimnion may become anoxic and the sediments of the mud/water interface may be chemically reduced.	Bottom mud and water are resupplied with oxygen.
Sediment at the mud/water interface usually will be oxidized.	Sediment at the mud/water interface is still oxidised.	Waters of the Hypolimnion may be nutrient-rich both from solution of particles settling down from the surface water and from solution of nutrients from reduced bottom mud.	Surface water is resupplied with nutrients, which may result in blooming of phytoplankton at the surface.

B.O.D (Biological oxygen demand)

Mass of oxygen consumed by microorganisms in a sample of water in a given time - usually measured as the mass (in mg) of oxygen used by 1dm³ of water stored in darkness at 20°C for 5 days.

B.O.D indicates the oxygen not available to more advanced organisms. Therefore a high B.O.D indicates anaerobic conditions (low oxygen availability).

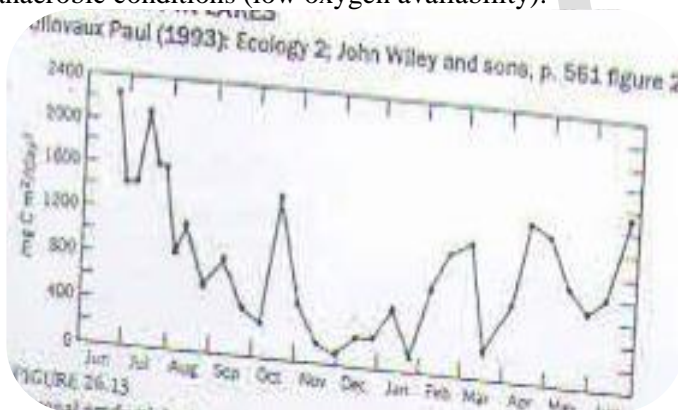

- Productivity then falls during the summer, despite the fact that this is the warmest time of the year with long days. This is because the short-lived algae of the spring bloom are not replaced and the standing crop is lowered, ending the bloom.
- But productivity goes up again with the coming of autumn, despite lowered temperatures. This is because of the fall overturn, which brings to the surface nutrient-charged water formerly held in the hypolimnion

Explanation for the observed changes

- Productivity is low in winter due to short days and low temperatures.
- Productivity is high in spring due to proliferation of algae causing blooming because of the warming that precedes summer.
- But the lake then stratifies and the process of exporting nutrients to the hypolimnion via precipitating organic matter proceeds to lower nutrient concentrations in the Epilimnion.

Oxygen and carbondioxide availability in water

Oxygen enters an aquatic system from the atmosphere and through photosynthesis by aquatic producers, and is removed by aerobic respiration of plants, animals and decomposers.

Carbondioxide enters an aquatic system from the atmosphere and through aerobic respiration by plants, animals and decomposers, and is removed by photosynthesising plants. Some dissolved CO₂ forms carbonate ions (CO₃²⁻), which are stored as calcium carbonate for long periods in sediments, minerals and shells and skeletons of aquatic animals.

Stratification in tropical lakes

In tropical lakes, the range of temperature from top to bottom of the columns of water is not great because the density of water changes more rapidly at higher temperatures.

The hypolimnion in a lowland tropical lake is nearly always without oxygen due to;

- i) high productivity caused by high temperature
- ii) biological decomposition of the large inputs of organic matter from productive tropical ecosystems on the banks.

The typical jungle lake therefore, is turbid, murky and opaque with biological activity.

Terrestrial ecosystems

Regional climates interact with regional biota and substrate to produce large recognizable community units called biomass. A biome is identical with a major 'plant formation' but it is a total community unit in which both animals and plants are considered. The six major biomass of Africa include:

- | | |
|-----------------------------------|------------------------------|
| ❖ Tropical rain forest | ❖ Sahel region (semi-desert) |
| ❖ Tropical savanna and grass land | ❖ Mountain forests |
| ❖ Desert | ❖ Temperate region |

The above form the major terrestrial ecosystems.

Tropical rain forest ecosystem

This is characterized by high temperatures of 25°C and 35°C and a high monthly rain fall distributed over 10 months of the year i.e. 200 and 400 cm³ of rain fall annually. They are dominated by broad leaved evergreen trees which occupy low altitude zones near the equator (amazon, Congo, Malaysia, etc.).

Seasonal changes in breeding and other activities of plants and animals in a tropical rain forest are largely related to variations in rain fall and to a certain extent temperature.

Forest communities are well structured and contain specific plant and animal populations that interact in a complex fashion.

Trees in the forest form three layers (stratification):

1. Emergent layer:

This consists of scattered, very tall emergent trees (80-100m) that project above the general level. They have wide spread, umbrella shaped crowns and huge buttresses. Examples are the *Chlorophora excelsa* (Mvule), mahogany, mbizia, e.t.c.

2. Canopy layer:

This forms a continuous evergreen carpet 50-80m tall. The crowns of such trees are small compared to the emergent and buttresses are narrow.

3. Undertone layer:

This includes relatively short trees 1-1, 20-40m tall and young trees of the emergent and canopy layers. Ferns e.g. platycerium spp is common as an epiphyte high on trees. Other epiphytic plants include figs and orchids.

Ground layer:

- This includes shrubs, herbs, lianas, shade loving plants with broad leaves and thallophytes e.g. lichen, mosses, liverworts and shade loving animals.
- A much large proportion of animals live in the upper layers of the vegetation. These include birds, mammals, amphibians and others. Some animals are ground dwellers e.g. ants, butterflies, moths, snakes and other reptiles.
- Tropical rain forests are rich in flora and fauna species e.g. a six square mile area can contain 20,000 species of insects. A tropical rain forest is the only major vegetation type which does not burn i.e. fire is not an ecological factor.
- Variation in environmental factors (temperature, light, moisture) caused by the stratifications creates micro-habitat conditions.

- The ground layer receives light of low intensity approximately 10% of the total value received by the emergent. Ground layer plants are therefore adapted to such conditions.
- The shade effect of the canopy layer cuts off the sun's rays, thus relatively lower temperatures are experienced in the lower layers.
- Moisture is influenced by temperature as it increases rates of evaporation and transpiration. Underground plants are in a region of lower rates of evaporation and transpiration than those above them.
- Crowded leaves on the upper layer of tree branches act as wind breaks so the interior of the forest is not windy. The relative humidity inside is relatively constant to the upper layers.

Adaptations

- ❖ Emergent and canopy layer trees prevent excessive transpiration by having leathery surface and adequate deposits of cuticle.
- ❖ Plants of the undergrowth have large thin leaves.
- ❖ Animals on the ground use the soil for protection against extreme condition.
- ❖ Arboreal animals possess special features that enable them to climb e.g. specialized feet in squirrels and the monkeys' prehensile tails.
- ❖ Some animals use camouflage for protection against predators.

Grass land ecosystem

- Tropical savanna (grassland with scattered trees or clumps of trees) forms the grassland ecosystem in Africa. Grasslands are characterized by hot weather with a moderate temperature range. Rainfall is about 120cm³ per annum which falls in one period, followed by a long period of drought.
- Grassland ecosystems are dominated by grasses such as guinea grass, elephant grass, spear grass, and palms.
- Animals include a variety of numerous hooved mammals e.g. antelopes, elephants, zebra, giraffes which graze or browse on the vegetation. Others include predators like lions, cheetahs, scavengers like hyenas, jackals and culture insects most abundant during the dry season which include grasshoppers, termites, ants and locusts. Reptiles are abundant during the dry season and these include snakes, lizards, chameleons, tortoise, etc.
- In the savanna grassland ecosystem, seasons are determined by rainfall. Other two factors include **herbivore** and **fire**. Trees and grass present must be resistant to drought and fire. This explains why the number of species in the vegetation is not large.
- Grazing mammals are important in determining the flora composition of the community. Some species of grasses and other plants are more sensitive to grazing pressure than others.
- During the dry season, fire is a major ecological factor. It destroys non-resistant plant species like grasses but it also stimulates those with underground parts to grow. Trees develop a dense and shady canopy and grasses grow to high heights during the short rainy season.

Adaptations

- ❖ Savanna trees grow long tap roots and develop thick barks which enable them to survive the long dry season and resists fires. They have umbrella shaped canopies which shade the ground and limit loss of soil moisture. The leaves have thick surfaces which minimize the loss of water by transpiration.
- ❖ Grasses have durable roots which remain underground when the tops have been burnt away after a fire. They sprout again with the onset of the first rains in the following year.
- ❖ Animals usually migrate and hibernate.

ECOLOGICAL SUCCESSIONS

- Ecological succession is a gradual change in community composition from the initial colonization of an area/habitat to establishing a relatively stable community. *Or*
- Ecological succession is a fairly orderly process of changes of communities in a region or an area. It involves replacement in the course of time of the dominant species within a given area by other species. *Or*
- It's the establishment of a sequence of different communities in a particular area over a period of time.
- **A community** is a group of interacting populations living in a given area and represents the living part of an ecosystem. Its functions are energy flow and cycling of nutrients. The structure of a community is always built up over a period of time until a stable climax community is established. Ecosystems are dynamic, constantly changing in response to both physical and biological factors.
- Communities succeed each other in an orderly sequence in which such successive stage i.e. it's dependent on the one that precede it.
- Succession progresses gradually from a small number of colonizing species known as **seres or seral stages** (i.e. communities that replace one another in a given area are called seres. These temporary consists the seral stages/seral communities).
- Each sere has its own community of organisms until the terminal relatively stable and final stage community called climax community.
- **The climax community** comprises of dominant or several co-dominant species which refers to species with the greatest collective biomass/productivity and physical size of individuals in a given area after some time (years).
- At climax community the net productivity/biomass tends to remain constant but dependent on species number and population size.

Types of succession

1. Primary succession

2. Secondary succession

Primary succession

It occurs during the colonization of uninhabited area or where no new life previously existed e.g. volcanic islands, bare rocks, sand dunes, lake shore, river banks, bare pavements, bare soil surface, dry area devoid of vegetation, ponds, swamps.

An example of succession on a rock:

- (i) On a bare rock/bare pavement several seral stages are identified, *lichens* (algae and fungi) are the *pioneer community* to be established first. They are able to utilize the low moisture, nutrients, and ions on rock surface. The hyphae of the fungi penetrate the tiny pores on the rock providing a firm attachment and absorbing inorganic nutrients from the rock while the algae provide food since it is photosynthetic. Bacteria and fungi also aided by weathering loosen rock surface by the process of rock decay. Their decaying bodies (algae/fungi and bacteria) add humus to the loosen rocks to form sedimentary soils.
- (ii) The loosen rock is now able to be inhabitable by the drought resistance *second colonizers* to support plant life of rhizoids on humus/traps the tiny organic and inorganic debris and water/moisture and further loosen the rock surfaces. Also death of some moss plants add nutrients to the soil due to decay by saprophytic organisms, more soil is formed to support the germination of seeds/grass of the large colonizing angiosperms/vascular plants. Small animals like insects, molasses, earth worms, and rodents break down rocks. The herb seeds germinate to replace proceeding growths

and they in turn provide suitable conditions for large woody shrubs to begin to grow in the newly fertile formed soils.

(iii) Eventually as a thicker layer of soils develops, shrubs get replaced by deciduous trees with deeper roots that penetrate crevices/cracks. The seeds of the trees become germinated/grow in the created suitable conditions by their parents' previous plants and animal colonizers and the mature forest community develops which becomes self-sustaining.

Note:

As the number of tree species increase, there is increased modification of the micro climates in the habitat e.g. shade increases, making light demanding shrubs to disappear and are replaced by light tolerant species of trees. The tolerant species of trees finally form the climax vegetation. The savanna grass land and forest ecosystems are the dominant terrestrial ecosystems.

Summary:

Pioneer species → animals (mosses) → herbaceous perennials (herbs) → shrubs → tree → forest

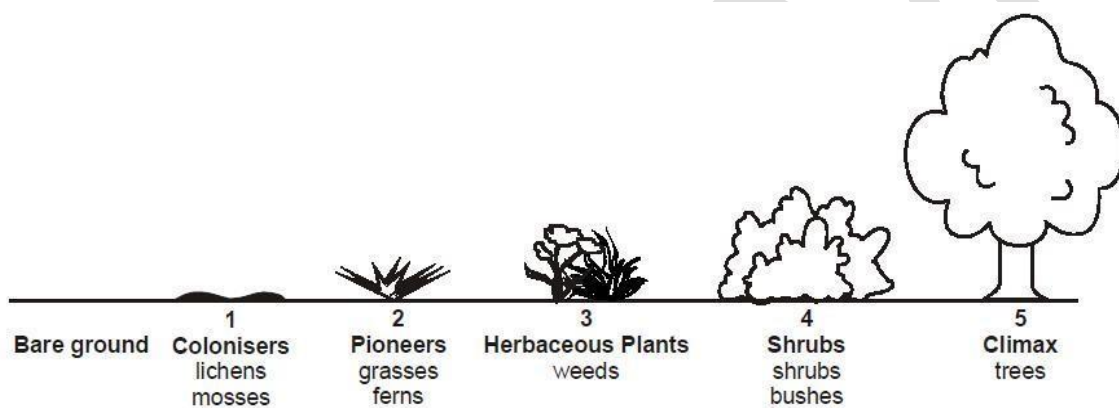

Secondary succession

This is the establishment of communities on areas/habitats previously occupied by developed communities but has been disrupted in some ways such as burnt farm, playground fire cleared, forests destroyed by natural disaster like hurricanes, drought, volcanic eruption, floods, human activities like fires, cultivation, fire, overgrazing.

Such areas have seeds/spores, organs of vegetative reproduction/propagation rhizomes and abundant nutrients in soil to support life. The successions are called secondary seres. E.g. fires from lightening burn plants stable community living a bare ground. The ground layer plants are killed, the heat destroys hollow roots/seeds and animals burnt in soil.

Often the first green plants on a burnt wood ash are the mosses that form an extensive green carpet. Within carpet the seeds of herbaceous and woody plants germinate. A new herbaceous layer grows, forming the grasses and followed by shrubs and trees. Each dominant plant community has associated dominant animal population within it. The climax community persists for a long time until when factors that favour that favour invasion of better adapted forms of organisms set in.

The climax vegetation makes efficient use of resources of the community ensuring indefinite self-sufficiency i.e. a community maintaining itself.

A similar secondary succession takes a short time to reach climax community. This is because the soil is already formed and supports growth of a wide range of plants immediately.

Note:

Both primary and secondary succession is affected by the animal (fauna) and flora (plants) of the surrounding environment/areas through dispersal and migration

Characteristics of a succession process	Factors affecting the number and diversity of species reaching an area/colonization
<ul style="list-style-type: none"> ❖ A pioneer community which is quite simple in biomass content and composition. ❖ A series of intermediate stages/seres ❖ Increasing biomass/productivity and species biodiversity ❖ Ends into a stable community which is in equilibrium with its environment called the climax community. 	<ul style="list-style-type: none"> ❖ Geographical barriers like mountain ranges/river/lake/rift valley. ❖ Ecological barriers like unfavourable habitats separating areas of favourable habitats. ❖ Distance over which dispersal must operate ❖ Size and nature of invasion areas

Characteristics of the stages of primary succession

Early succession	Late succession
<ul style="list-style-type: none"> • Species grow very close to the ground and have low biomass. • Species have short lifespan. • Species are simple and small sized. • Species diversity is very low. • The community is open i.e. allows space for further colonizers. • Species may show symbiotic relationships to aid their establishment. • Species are poor competitors and hence get replaced by higher, more demanding plants like grasses, shrubs and eventually trees. • Species can establish large populations quickly under harsh conditions like lack of moisture and soil nutrients, hot and cold temperature extremes. • The community is mostly composed of producers and a few decomposers. • Net productivity is high. • Feeding relationships are simple, mostly herbivores feeding on plant with few decomposers. 	<ul style="list-style-type: none"> • Plants are of large size and complex. • Species diversity is high. • The community is a mixture of producers, consumers and decomposers. • Biomass is high. • Net productivity is low. • Community takes a long time to establish. • The climax community is often determined by one dominant species. • There is increased soil depth and nutrients. • Interspecific competition is very high. • There is little space for new species. • The climax community is stable and is in equilibrium with its environment. • Feeding relationships are complex, dominated by decomposers.

Productivity and biomass

Biomass refers to the dry weight of organism(s) at a trophic level. The biomass at the time of sampling or given moment in time is called the standing biomass or standing crop biomass.

Ecosystem productivity increases until climax community but there is a decrease in gross productivity associated with the climax community. This could be due to an accumulation of nutrients in the increasing standing crop biomass may lead to a reduction in nutrient recycling. Reduction in vigour as the average age of the individuals in the community increases to a constant point would cause a reduction in productivity.

Climax communities lead to maximum accumulation of biomass. An upper limit of biomass is reached when total respiratory losses from the system are almost equal gross primary productivity i.e. the ratio of productivity to respiration = 1.

During succession, more and more of the available nutrients become locked up in the biomass of the community with subsequent decrease in nutrients in the abiotic component of the ecosystem (such as soil and water). The Amount of detritus produced also increases and detritus feeders take over from grazers as the main primary consumers. Appropriate changes food webs occur and detritus becomes the main source of nutrients.

The process or trend of succession on a bare rock or bare pavement or bare soil surface or dry area is devoid of vegetation. On bare rock the first organisms to colonize the area are lichen/bacteria/fungi aided by weathering loosens rock by the process of rock decay. Their dead bodies add humus to the loosen rock enabling algae growth. The invertebrates invade and feed on them. When these organisms die and decompose and their metabolic wastes cause rock weathering leading to soil formation. Mosses/liverwort would then come in including insects that feed on them. Other plants with better roots like ferns and animals like earth worms, molluscs, amphibians, birds, reptiles and mammals comes in. Evergreen plants with deeper roots like vascular grasses, shrubs and trees and then come in animals which finally form a climax community.

Note:

The biomass of the climax community is higher also in cleared forest than in developing community, e.g. algae growing on a concrete. This is so because a formerly cleared forest has the soil substratum rich in organic matter/nutrients on which woody species can grow very fast accumulating organic matter. However on a rock/concrete/non-decomposable blocks little or no nutrients are obtained slow growth occurs so less accumulation of organic matter or biomass occurs. The algae are small in size contributing less organic matter. Therefore trees have a higher biomass since they accumulate it over a long time period compared to the small algae.

Energy flow through an ecosystem

The **first thermodynamic law** states that energy cannot be created or destroyed but can be transferred from one form to another.]

The **second thermodynamic law** states that when energy is transformed from one form to another, there is loss of energy through the release of heat.

The fate of solar energy reaching the earth

Because of the small size, the earth receives only about one-billionth of the sun's output of energy, much of the energy being either reflected away or absorbed by chemicals in the atmosphere.

- Most of the energy that reaches the atmosphere is: (i) visible light (ii) infrared radiation-heat (iii) ultra violet radiation that not absorbed by ozone.
- The incoming energy (i) warms the troposphere and land (ii) evaporates water and cycles it through the biosphere (iii) generates winds (iv) is captured by green plants, algae and bacteria to fuel photosynthesis and make the organic compounds that most forms of life need to survive.

Factors that sustains life on earth

Three interconnected factors sustain life on earth:

- The one-way flow of high quality energy from the sun:
 - Through materials and living organisms in their interactions
 - Into the environment as low quality energy – mostly heat dispersed into the air or water molecules at low temperature.
 - Eventually back into space as heat.
- The cycling of matter through parts of the biosphere
- Gravity, which:
 - Allows the planet to hold on to its atmosphere.
 - Causes the downward movement of chemicals in the matter cycles.

How the sun sustains life on the earth

- Lights and warms the planet.
- Supports photosynthesis in plants and some bacteria.
- Powers the cycling of matter.
- Drives the climate and weather systems that distribute heat and fresh water over the earth's surface

Food chain

This is a simplified sequence illustrating the flow of energy from one organism to another in a community.

Grazing food chains start with green plants while **detritus food chains** begin with dead organic matter e.g. in temperate forests

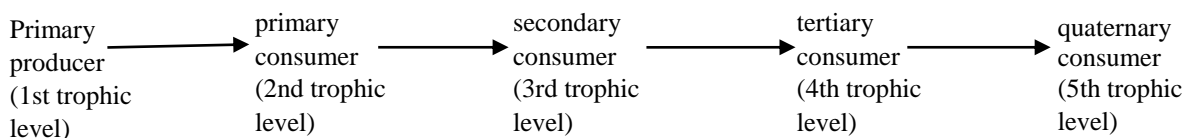

Example of food chain:

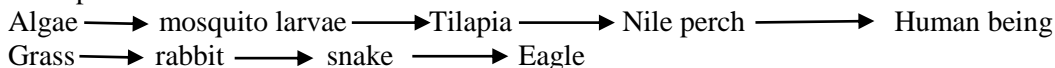

Detritivore food chain

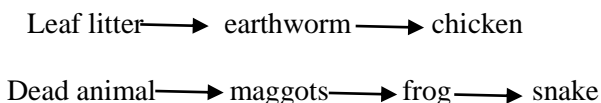

A food web is shown below;

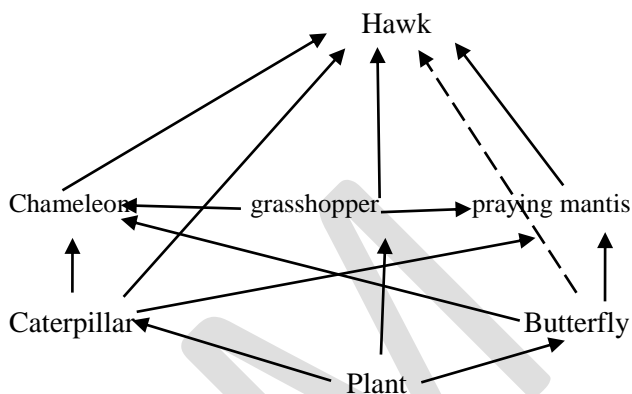

Food web

This is a complex nutritional relationship showing alternative sources of food for each organism in a food chain i.e. a complex network of food chains linked to one another.

An outline of the process of energy flow through the ecosystem

The primary source of energy is the sun. Of the energy received by the earth, less than 0.1% is fixed by green plants as chemical energy in biomass in organic substances during photosynthesis (Gross Primary Production); the rest is reflected by the atmosphere, heats the earth’s surface or causes evaporation of water.

Part of gross primary production is used by green plants for aerobic respiration while what remains (**Net Primary Production**) is used as food by primary consumers, during which only about 5 – 10% of the energy is transferred from producer to primary consumer (a loss of 90 – 95% occurs) because much of plant biomass is indigestible to herbivores. The energy obtained by herbivores through feeding on producers is less than what producers get from the sun because some is lost in egestion, excretion, and not all parts are eaten.

When carnivores eat herbivores still the energy they obtain is less than what herbivores obtain from feeding on producers, and the trend is maintained even as top carnivores feed on secondary consumers. Therefore, with each energy transfer some usable energy is degraded and lost to the environment as low quality heat, thus the energy available to each successive trophic level declines, and the more trophic levels in a food chain or web, the greater the cumulative loss of energy during its flow through the various feeding levels. This limits the number of feeding levels to 3 or 4, or very rarely 5 or 6.

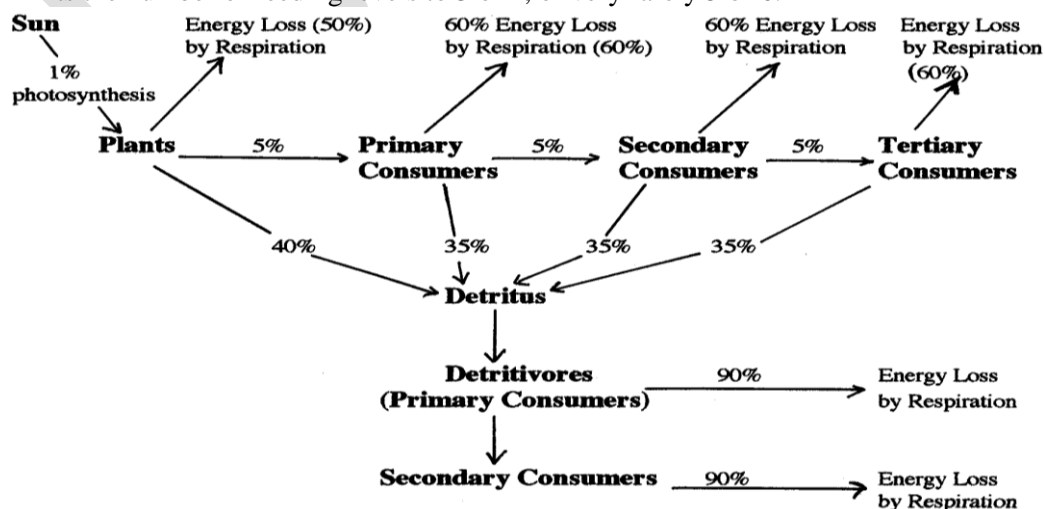

Note: carnivores are more efficient, transferring about 20% of the energy available from their prey into their own bodies. It is the relative inefficiency of energy transfer between trophic levels that explains why;

- Most food chains have only four or five trophic levels

- The biomass of organisms is less at higher trophic levels
- The total energy stored is less at each trophic level as one moves up a food chain

Energy budgets

An energy budget shows the percentage allocation of energy consumed by an individual organism to the various processes in the body such as respiration, growth and reproduction.

Terms associated with energy budgets

Term (Definition and explanation)	Extra facts
<p>Gross primary productivity (GPP)</p> <ul style="list-style-type: none"> • It is the rate at which producers convert solar energy into chemical energy stored in organic substances. • It is the total amount of energy fixed by producers per unit area of photosynthetic surface per unit time. • Productivity may be expressed as units of energy (e.g. $\text{kJm}^{-2}\text{yr}^{-1}$ or $\text{kCal m}^{-2}\text{yr}^{-1}$), or units of mass (e.g. $\text{kg m}^{-2}\text{yr}^{-1}$) 	<p>GPP is greatest: (i) in shallow waters near continents (ii) along coral reefs where abundant light, heat and nutrients stimulate the growth of algae. (iii) Where upwelling currents bring nitrogen and phosphorus from the ocean bottom to the surface.</p> <p>GPP is lowest in: (i) deserts due to low precipitation (rainfall, hail, snow, sleet) and intense heat (ii) the open ocean due to lack of nutrients and sunlight except near the surface.</p>
<p>Net primary productivity (NPP)</p> <ul style="list-style-type: none"> • It is the rate at which energy for use by heterotrophs or consumers is stored in new organic substances. • NPP is the energy that remains to be used by consumers after producers have used part of GPP for their own respiration. <p>NPP = GPP – (respiration + metabolism)</p>	<p>NPP most productive ecosystems are: (i) Estuaries (ii) Swamps and marshes (iii) Tropical rainforests</p> <p>NPP least productive ecosystems are: (i) Open ocean (ii) Tundra – arctic and alpine grasslands (iii) Desert.</p> <p>Despite its low net productivity, the open ocean produces more of the earth's NPP per year than any other ecosystem because of its large size</p>
<p>Secondary production</p> <p>It is the rate which energy is used to make new biomass in consumers</p>	<p>This the energy remaining in heterotrophs available for production (growth, repair and reproduction) after losses through egestion, excretion and respiration</p>
<p>Biomass</p> <p>It is the dry weight of all organic matter contained in organisms per unit area of ground or water</p>	<p>Biomass is expressed as g/m^2</p>
<p>Standing biomass (Standing crop biomass)</p> <p>It is the dry weight of all organic matter contained in organisms per unit area of ground or water at a given moment in time</p>	
<p>Trophic efficiency (Ecological efficiency)</p> <p>It is the percentage of energy at one trophic level that is converted into organic substances at the next trophic level</p>	<p>Trophic efficiencies range from less than 1% (e.g. herbivores eating plant material) to over 40% (e.g. zooplanktons feeding on phytoplanktons)</p>

NOTE:

- Of the energy received by the earth, averagely less than 3% is fixed by green plants.
- Energy transfer from producer to primary consumer is typically in the order of 5 – 10% of NPP (a loss of 90 – 95% occurs) because:
 - Much of plant biomass (**NPP**) is indigestible to herbivores e.g. no animal enzymes can digest lignin and cellulose
 - An individual herbivore may not eat much of the plant biomass e.g. roots may be inaccessible.
- Energy transfer from primary consumers (herbivore) to secondary consumers (carnivores) is typically 10 – 20% of herbivore mass (a loss of 80 – 90% occurs).

This more efficient than in (b) above because:

- Animal tissue is more digestible than plant tissue
- Animal tissue has a higher energy value
- Carnivores may be extremely specialized for prey consumption.

But still less than 100% because:

- Some animal tissue e.g. bones, hooves, hides is not readily digestible

ii) Feeding is not 100% efficient – much digestible material e.g. blood and food fragments may be lost to the environment.

d) The number of trophic levels (feeding levels) rarely exceeds five because: The more trophic levels in a food chain or web, the greater the cumulative loss of usable energy as it flows through the various trophic levels, leaving very little energy to support organisms feeding at the high trophic levels.

This explains why:

- i) There are so few top carnivores e.g. eagles, hawks, tigers, white sharks
- ii) Such species are first to suffer when the systems that support them are disrupted
- iii) These species are so vulnerable to extinction.

The longest food chains can only be supported by an enormous producer biomass e.g. in oceans.

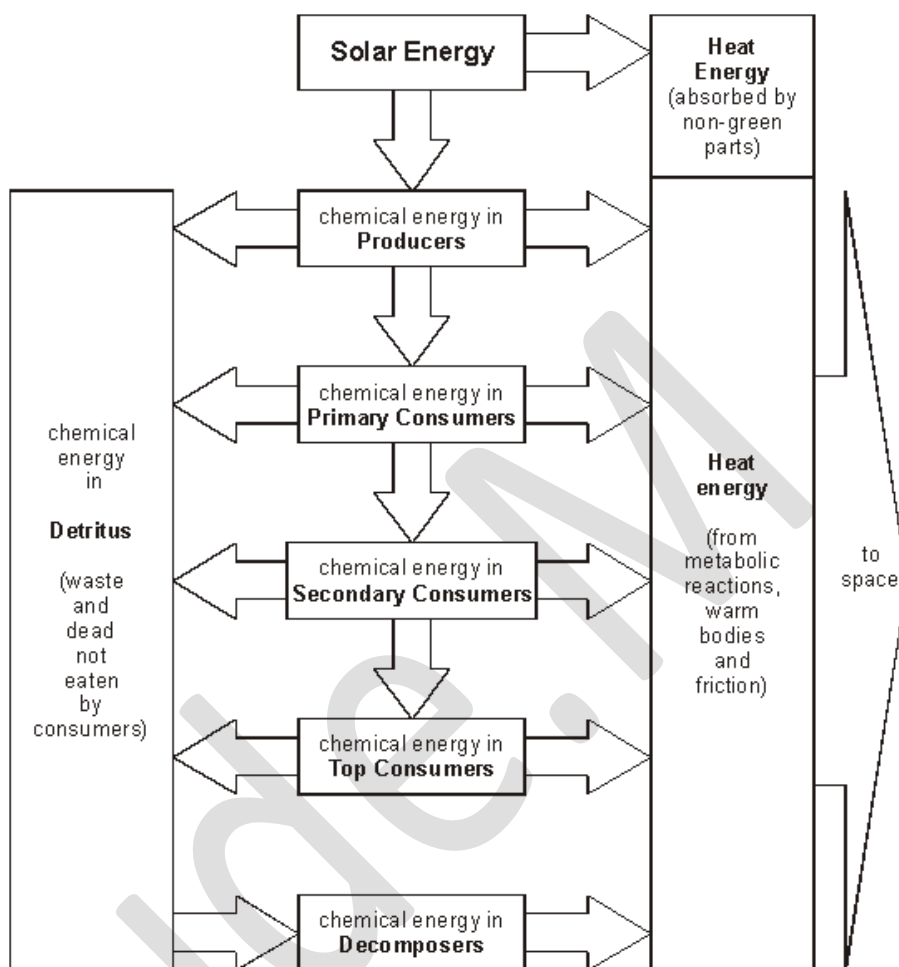

ECOLOGICAL PYRAMIDS

These are histograms that provide information about trophic levels in ecosystems.

Pyramid of numbers

It is a histogrammatic representation of the numbers of different organisms at each trophic level in an ecosystem at any one time.

Note:

- i) The number of organisms at any trophic level is represented by the length (or area) of a rectangle.
- ii) Generally, as the pyramid is ascended, the number of organisms decreases, but the size of each individual increases.

[Toole pg. 338 fig. 17.3a]

Disadvantages:

- i) Drawing the pyramid accurately to scale may be very difficult where the range of numbers is large e.g. a million grass plants may only support a single top carnivore.
- ii) Pyramids may be inverted; particularly if the producer is very large e.g. an oak tree or parasites feed on the consumers e.g. fleas on a dog (B & C)
- iii) The trophic level of an organism may be difficult to ascertain.
- iv) The young forms of a species may have a different diet from adults, yet they are considered together.

[Toole pg. 338 fig. 17.3b]

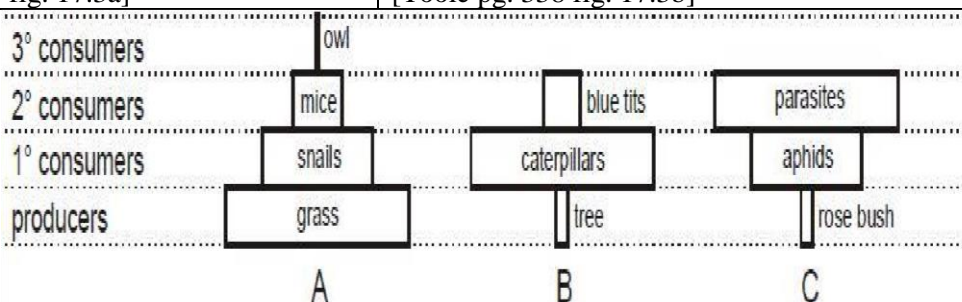

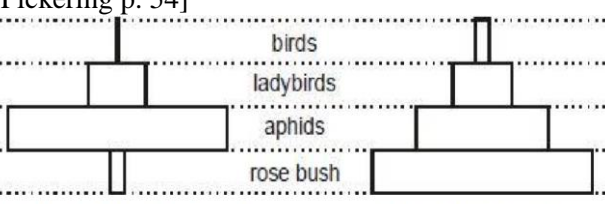
<p>Pyramid of biomass It is a histogrammatic representation of the biomass (number of individuals x mass of each individual) at each trophic level in an ecosystem at any one time.</p> <ul style="list-style-type: none"> Biomass is expressed as g/m^2 <p>Advantage: It eliminates scale problems encountered when constructing a pyramid of numbers.</p> <p>Disadvantages:</p> <ol style="list-style-type: none"> Biomass may change with time It does not show productivity Problems encountered in determining the biomass since it involves killing and drying the organisms An inverted pyramid of biomass can occur if the producer level includes organisms with a high turnover rate (rapid reproduction) so that they have a high productivity over a period of time e.g. in open water of oceans, the zooplankton biomass can exceed that of phytoplankton because the former eat the latter almost as fast as they are produced, so the producer population is never very large 	<p>[Pickering p. 54]</p>  <p>pyramid of numbers pyramid of biomass</p> <p>The sampling situation at any one time deals with standing crop biomass (amount of material present at a particular instant) rather than with productivity (the capacity of any trophic level to produce biomass over a period of time) e.g. zooplankton in a marine ecosystem.</p>
<p>Pyramid of energy flow It is a histogrammatic representation of the flow of energy through each level of an ecosystem during a fixed time period (usually one year, to account for seasonal effects).</p> <ul style="list-style-type: none"> Energy values may be expressed variously e.g. $kJm^{-2}yr^{-1}$ or $kCal m^{-2}yr^{-1}$ <p>[Pickering p. 54]</p> <p>Note:</p> <ol style="list-style-type: none"> Because such pyramids represent energy flows, not energy storage, they should not be called pyramids of energy (a common error in some books) Energy flow pyramids explain why the earth can support more people if they eat at lower trophic levels by consuming grains, vegetables and fruits directly rather than passing such crops through another trophic level and eating grain eaters. 	<p>Advantage:</p> <ol style="list-style-type: none"> It compares productivity because a time factor is incorporated. Biomass may not be equivalent to energy value, e.g. 1g of fat has many more kJ than 1g of cellulose or lignin. No inverted pyramids are obtained because of the automatic degradation of energy quality. The solar input of energy may be included as an extra rectangle at the base. <p>Disadvantage: Obtaining the necessary data required in constructing pyramids of energy flow is difficult.</p> <p>[Soper Fig. 10.9 pg307]</p>

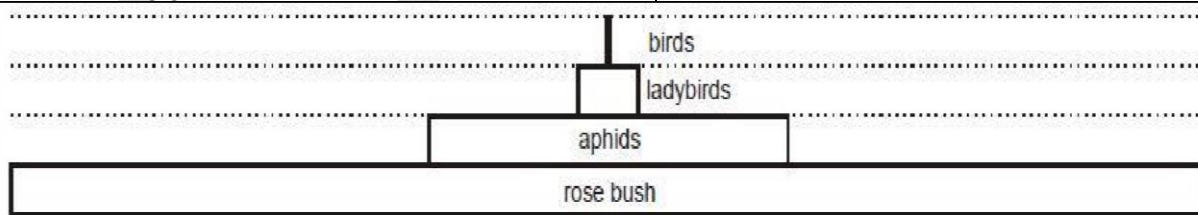

BIOLOGICAL AND GEOCHEMICAL CYCLING (NUTRIENT CYCLING)

This is the process by which chemical compounds of a particular element that constitutes living matter are transferred between living organisms (biotic phase) and non-living environment (abiotic phase). Because nutrient cycles involve both biotic and abiotic components, they are called **biogeochemical cycles**. A general model of nutrient cycling is shown on the right

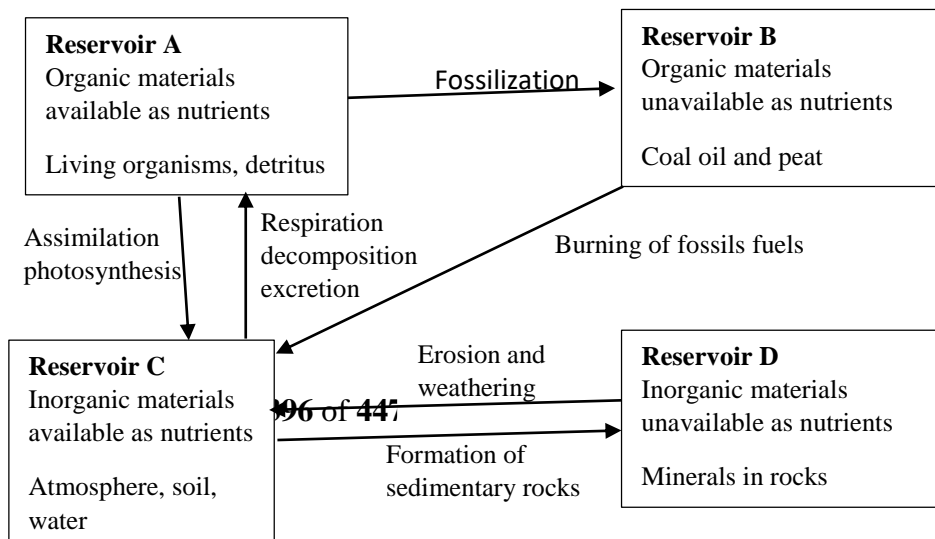

BS page 301 fig 10.3	<p>These cycles driven directly or indirectly by incoming solar energy and gravity include the carbon, nitrogen, phosphorus, oxygen, Sulphur and hydrological (water) cycles, but a few have been considered below. The earth's chemical cycles also connect past, present and future forms of life. Just imagine:</p> <p>i) Some of the carbon atoms in your skin may once have been part of a leaf.</p> <p>ii) Some of the oxygen molecules you just inhaled may have been inhaled by a person at Jesus' time!</p>
----------------------	--

1. Hydrological (water) cycle

The water cycle is powered by energy from the sun and by gravity, and it involves the following main processes:

- Evaporation (conversion of water into water vapour)
- Transpiration (evaporation from leaves of the water extracted from soil by roots and transported throughout the plant)
- Condensation (conversion of water vapour into droplets of liquid water)
- Precipitation (rain, hail, snow and sleet)
- Infiltration (movement of water into soil)
- Percolation (downward flow of water through soil and permeable rocks to ground storage areas called aquifers)
- Runoff (downslope surface movement back to the sea to resume the cycle)

2. Carbon cycle

- The carbon cycle is based on carbon dioxide gas, which makes up 0.036% of the volume of the troposphere and is also dissolved in water.
- Carbon fixation involves the reduction of carbon dioxide to large organic molecules during photosynthesis and chemosynthesis.
- During aerobic respiration, the carbon in glucose and other complex organic compounds is converted to carbon dioxide into the atmosphere or dissolves in water.
- Over millions of years, buried deposits of dead plant debris and bacteria are compressed between layers of sediment to form the carbon-containing fossil fuels e.g. coal, oil and natural gas, which when burnt release carbon dioxide into air. In natural ecosystems the carbon in the carbon-containing fuels would be lost from the cycle. It should be noted that the production of fossil fuels is a very slow process and there is a limit to the rate at which man draw upon them. The so-called energy crisis results from this obvious ecological fact.
- In aquatic ecosystems, carbon dioxide may
 - remain dissolved
 - be utilised in photosynthesis
 - react with water to form carbonate ions (CO_3^{2-}) and bicarbonate ions (HCO_3^-).
- As water warms, more dissolved carbon dioxide returns to the atmosphere.
- In marine ecosystems, some organisms take up dissolved carbon dioxide molecules, carbonate ions (CO_3^{2-}) and bicarbonate ions (HCO_3^-) and these ions react with calcium ions (Ca^{2+}) to form calcium carbonate (CaCO_3) to build their shells and skeletons.
- When the animals with calcium in shells and skeletons die and drift into deep bottom sediments of oceans, immense pressure causes limestone and chalk to form after a very long period of time.
- Weathering processes release a small percentage of carbon dioxide from limestone into the atmosphere

[Roberts pg 532 fig 32.12]

How human activities affect the carbon cycle

- i) Clearing of trees and other plants that absorb CO₂ through photosynthesis results in its increased concentration.
- ii) Burning of fossil fuels and wood adds large amounts of CO₂ into the troposphere.

3. Nitrogen cycle

- Nitrogen is the atmosphere's most abundant element, with chemically unreactive nitrogen gas making up 78% of the volume of the troposphere. However, nitrogen gas cannot be absorbed and metabolized directly by multicellular plants and animals.
- Atmospheric electrical discharges in the form of lightning causes nitrogen and oxygen in the atmosphere to react and produce oxides of nitrogen, which dissolve in rainwater and fall to the ground as weak acidic solutions e.g. nitric acid.
- Nitrogen fixation occurs when the nitrogen in soil is reduced to ammonium ions, catalysed by nitrogen-fixing bacteria which may be free-living e.g. *Azotobacter*, symbiotic in root nodules e.g. *Rhizobium* or cyanobacteria e.g. *Nostoc* or by nitrogen-fixing blue-green algae in water bodies.
- Nitrification occurs when ammonium compounds in soil are converted first to nitrite ions by *Nitrosomonas* bacteria and later to nitrate ions by *Nitrobacter* bacteria.
- Ammonification (putrefaction) occurs when decomposers e.g. some bacteria and fungi convert nitrogen-rich organic compounds, wastes like urea and dead bodies of organisms into ammonia and ammonium ion-containing salts.
- Assimilation occurs when inorganic ammonia, ammonium and nitrate ions are absorbed by plant roots to make DNA, amino acids and protein.

- Denitrification occurs when mostly anaerobic bacteria e.g. *Pseudomonas denitrificans* and *Thiobacillus denitrificans* in water logged soil and deep in ocean, lake and swamp bottoms convert ammonia and ammonium ions back into nitrite and nitrate ions, and then into nitrogen gas and oxygen. Nitrogen gas is released into the atmosphere while oxygen is used for the respiration of these bacteria.

Soper page 311 fig 10.11

How human activities affect the nitrogen cycle

<p>1. Burning of fuels forms nitric oxide, which reacts with atmospheric oxygen to form nitrogen dioxide gas that reacts with water vapour to form acid rain containing nitric acid. Nitric acid together with other air pollutants;</p> <ul style="list-style-type: none"> a) damages trees b) corrodes metals c) upsets aquatic ecosystems. <p>2. The inorganic fertilizers applied to soil are acted upon by anaerobic bacteria to release nitrous oxide into the stratosphere, where it;</p> <ul style="list-style-type: none"> a) contributes to ozone depletion b) contributes to greenhouse effect. 	<p>3. Nitrogen is removed from top soil when we;</p> <ul style="list-style-type: none"> a) harvest nitrogen-rich crops b) irrigate crops c) burn or clear grasslands and forests before planting crops <p>4. Adding nitrogen compounds to aquatic ecosystems e.g. sewage algal blooming, which upon death, their decomposition causes oxygen shortage resulting into death of aerobic organisms e.g. some fish.</p> <p>5. The accelerated deposition of acidic nitrogen containing compounds e.g. NO₂ and HNO₃ onto terrestrial ecosystems stimulates growth of weeds, which outcompete other plants that cannot take up nitrogen as efficiently.</p>
---	--

QN. Describe the role of microorganisms in the nitrogen cycle.

3.0 POPULATION AND NATURAL RESOURCES

Population, population growth and population growth curves

Population density is the number of organisms per unit of space/area.

Population size: is the number of organisms of the same species sharing the same habitat at a certain time.

Population size change as a result of four factors natality (**birth**), mortality (**death**), migration in (**immigration**) and out (**emigration**) of the population.

Types of population

(a) Open population

This is the one in which density changes as a result of the interaction of mortality, natality, migration and emigration. It occurs in a natural environment.

(b) Closed population/cultured populations

This is one in which density changes are the result of natality and mortality with neither food nor wastes being allowed to enter or leave the given environment. It occurs in laboratory settings and game reserves/cultured populations

Biotic potential.

The **maximum rate** at which a population can **increase** under ideal conditions i.e. when population density is low and resources are plentiful.

The biotic potential depends on the **age structure** and **male: female** ratio existing in the population. It is also influenced by the age at which the individual first reproduces, the frequency at which reproduction occurs, the reproductive life span and the number of the offsprings the individual is capable of producing.

Factors that tend to increase or decrease population the size of a population

Factors that cause a population to grow (Biotic potential)	Factors that cause population size to decrease (Environmental resistance)
i) Favourable light – mostly for plants. ii) Favourable temperature. iii) Favourable chemical environment (optimal level of critical nutrients and toxic wastes). iv) High reproductive rate. v) Adequate food supply vi) Ability to compete for resources. vii) Ability to hide from or defend against predators. viii) Ability to resist disease and parasites. ix) Ability to adapt to environmental changes. x) Ability to migrate and live n other habitats. xi) Suitable habitat. xii) Generalised niche	i) Too much or too little light, mostly for plants. ii) Too much or too little temperature. iii) Unfavourable chemical environment (too much or too little of critical nutrients and high waste accumulation). iv) Low reproductive rate. v) Inadequate food supply vi) Too many competitors for resources. vii) Insufficient ability to hide from or defend against predators. viii) Inability to resist disease and parasites. ix) Inability to adapt to environmental changes. x) Inability to migrate and live n other habitats. xi) Unsuitable or destroyed habitat. xii) Specialised niche

Population Histograms

Population growth curves only show how populations change over time but don't tell or show the age distribution of the members. The population histograms show or represent population of an organism in terms of its age structure and the proportion of males and females at a specific instant in time (sex ratios).

Note, the study of vital statistics of populations and how they change over time is called demography. Such statistics include birth rate and how they vary among individuals and death rate

Age distribution/structures

It's the proportion of the individuals of different ages in their population. It is an important factor because it influences mortality and natality. It's determined by:

- i) Observing the teeth and bones of organisms.

- ii) Observing horns, claws, rings and scales, etc. depending on different types of animals or organisms or plants. E.g. some animals or organisms show annual increment in rings e.g. scales in fish and horns in cattle.
- iii) In invertebrates and some vertebrates, weight and size are used to determine the age of an individual.

Types of ecological ages

1. Pre-reproductive age; represent organisms that are below the reproductive age (between 1-14 years).
 2. Reproductive age; shows organisms of the population able to mate or reproduce.
 3. Post-reproductive age; represent members that are old enough to reproduce e.g. 65+ years in humans.
- The relation duration/time of each one age varies with different species. Age structure is studied using the age sex graph or population pyramids. It deals with relationships in number between males and females of age groupings.

Population growth

Natural populations start with small size and gradually increases to a climax/carrying capacity where it is no longer growing/increasing. At this point the population undergoes a number of changes as a result of the changes in the environmental factors.

Carrying capacity of a population refers to the maximum number of the individuals of a population which the resources in a particular environment can support maximally at a given time. At carrying capacity, changes in environmental factors such as food supply decline/reduced rainfall fluctuation in temperature or an outbreak of epidemics, temperature, etc. results in an increased death rate which over powers the birth rate hence leading to a fall in the population. This is known as a decline phase

Population growth curve of organism in a given habitat (sigmoid curve)

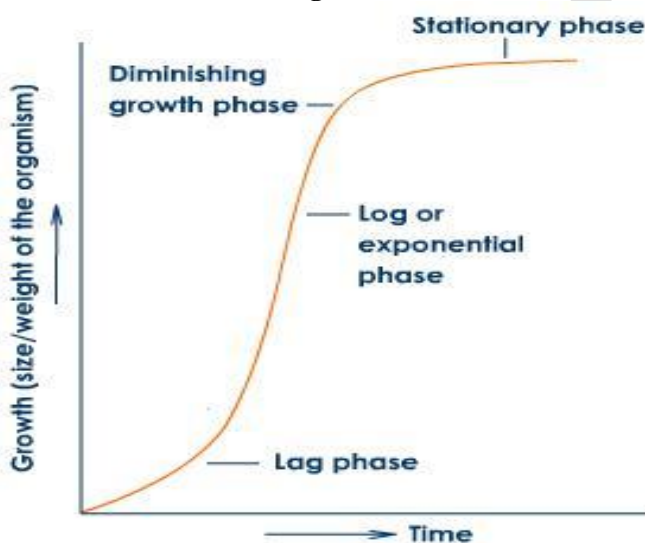

Lag phase:

This is the period of low growth rate because the reproducing organisms are few and the members are still adjusting to the environmental conditions. There is plenty supply of nutrients, space, oxygen and low or few wastes. At this point the decrease in the population is directly proportional to the group members/individuals that are reproducing.

Exponential/log phase:

This is the phase of fast increase in the population/increased rate of growth because the individuals are used to the environment, majority have reached their reproductive potential and there is no limiting factors such as food, space, oxygen hence the organisms are able to grow and reproduce at fast rate i.e. non environmental resistance.

Stationery phase:

This is also called the **equilibrium stage**. This occurs as a result of low growth rate. The birth rate decreases while the death rate increases as a result of shortage of food nutrients, over-crowding, accumulation of toxic waste products, predation and competition for the above resources amongst the death rate and birth rate are equal and the population size becomes stable or attains its climax which is called the stationery phase or **the carrying capacity** of the population i.e. **environmental resistance** is evident.

Environmental resistance

Refers to the sum total of limiting factors, both biotic and abiotic which affect together to prevent the biotic potential from being obtained or all the factors that tend to reduce population numbers, such as predation, food supply, heat, light, space, regulatory mechanisms like intraspecific competition and behavioral adaptation.

Mac Arthur and Wilson (1967) estimated population growth using the logistics equation i.e.

Population increase = Biotic potential (reproduction per individual) X No. of individuals X Relationship between carrying capacity and resources available

$$I = \frac{rN(K-N)}{K} \quad \text{Or} \quad rN(1-N/K) = dN/dt$$

For sigmoid growth curve
Where:

- t- Time
- r- biotic potential/maximum rate of increase of the population
- N- No. of individuals in the population
- K- Carrying capacity
- I- population change

Where the population is low, the I value is close to NVR

When the population increase and resources become depleted, I decrease sharply to zero where N=K.

The Logistic Growth Model According to the logistic equation $dN/dt = r_{max}N(K - N)/K$, growth levels off as population size approaches the carrying capacity.

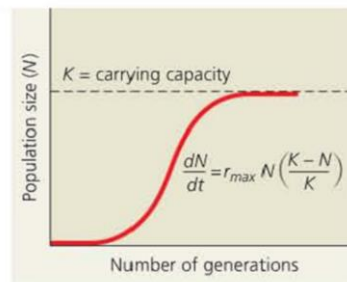

What happens when population size exceeds the carrying capacity?

The population suffers a dieback or crash, unless the excess individuals switch to new resources or move to an area with more favourable conditions.

Note. When a population reaches equilibrium it does not remain absolutely constant but fluctuates because of variations in the environment resistance. For a give species in a particular environmental situation there is a certain optimum population which the environment can support. This can be called the **norm** or **set point**. If the population rise above the set point, competition or predation takes place to such an extent that the population falls. If it falls below the set point environmental resistance if temporary relieved so that the population rises again. In the normal course of events populations fluctuate on either side of the set point, but the fluctuations are not excessive a clear case of **negative feedback**.

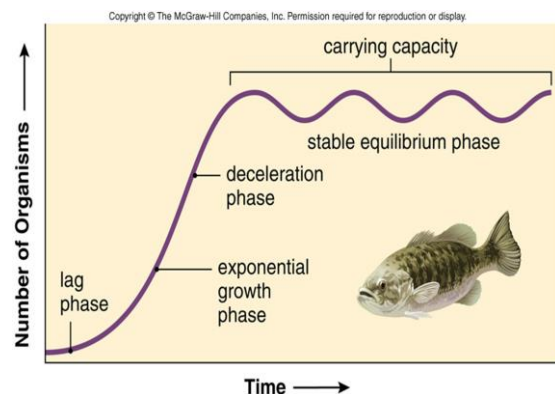
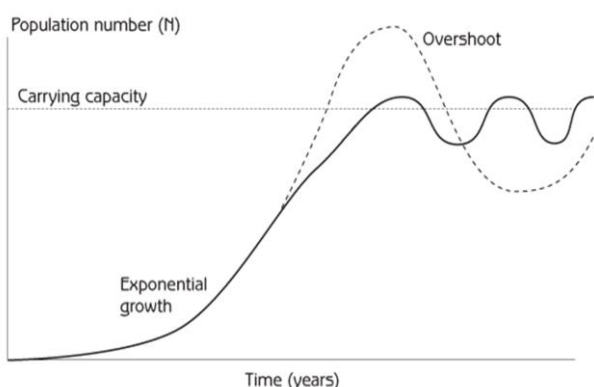

Control of the human population

The homeostatic control of the population breaks down if some factor of the environment is suddenly changed. Such factors could be removal of the predators for a given prey or decrease in competition for food, this would shift the set point which would increase the birth rate, reduction in the death rate. All this leads to an exponential increase in the population.

In the case of man, the environmental changes responsible for raising the set point have been created by man himself, and inevitably brings in problems such as food shortage and sheer physical over-crowding. Man’s

population has exploded due to (1) improvement in hunting and food gathering techniques i.e. tool making revolution (2) improvements in agriculture i.e. agricultural revolution (3) improvement in food production, industry and medicine i.e. the scientific-industrial revolution.

The only humane way of curbing the exponential increase in the human population is by **birth control**. This includes behavioural means such as abstinence, the rhythm method, coitus interruptus, contraceptives e.g. condoms, hormonal methods e.g. the contraceptive pill, various intra-uterine devices (IUDs), sterilization of male and female and abortion.

Types of growth curves

There are two basic forms, i.e. **J-shaped growth curve** and **S-shaped (sigmoid) growth curve**.

The above curves where there is a lag phase, exponential, stationary and declining phase describes a sigmoid curve or logistic population growth or S-shaped curve as a result of changes in both density dependent and density independent factors.

Population growth starts out slowly and then proceeds faster to a maximum (carrying capacity) and then levels off. Population then fluctuates slightly above and below the carrying capacity with time.

The population stabilises at or near the carrying capacity (K) of its environment due to environmental resistance

Exponential population growth (J-shaped curve)

This describes a situation in which after the lag phase/population growth continues in an exponential form 'boom' until when it stops abruptly and due to environmental resistance. The crash 'bust' (abrupt stoppage) may be caused by factors like seasonality i.e. end of breeding season of the organism or of prey species. The crash may also be due to human interaction like application of insecticides to control pests, herbicides to control weeds.

Growth is **density independent**.

It occurs when resources are unlimited and the population can grow at its intrinsic rate of growth. However this is rare in nature because of limiting factors (environmental resistance). E.g. (1) Algal blooms (2) some insect species e.g. long horned grasshoppers (3) *Bidens pilosa* (black jack) (4) If cats totally fed on prey/rats. The removal of prey results in the crash of the predator/cat population.

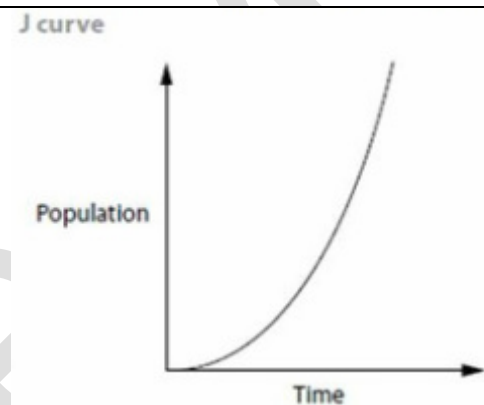

B.S pg 323 fig 10.19 (b)

Factors that influence population growth size

Collectively the factors which limit population growth are termed as environmental resistance and are grouped into two.

1. Density dependent (biotic) factors

These include diseases, competition for food, light, shelter, etc. assume there is a fixed food supply available for the organisms, the larger the population, the less the food available for each individual hence the slower the growth rate of the organism. However, a small population can expand more rapidly or exponentially.

2. Density independent (abiotic) factors

These affect the population regardless of the number of individuals within the community such as temperature, natural calamities, e.t.c.

<p>a. Climatic factors</p> <p>(1) Light: this affects the population growth and the distribution of organisms move so the plants. It is essential for (i) photosynthesis (ii) chlorophyll formation (iii) stomatal opening, hence gaseous exchange (iv) phototropism (v) flowering stimulants (vi) seed germination (vii) broadness of leaves and (viii) ripening of fruits. (ix) induces flowering in long-day plants e.g. barley, but (x) inhibits flowering in short day plants. In animals light enables (xi) hibernation, (xii) vision and (xiii) migration (xiv) Courtship; with some animals preferring light so as to carry out courtship while others prefer darkness (xv) Stimulates synthesis of vitamin D in mammals</p> <p>(2) Water/rain fall.</p> <p>(i) Habitat for many aquatic organisms e.g frogs, fish e.t.c. (ii) Raw material for photosynthesis High thermal capacities (iii) cooling agent for terrestrial organisms (iv) Agent for fruit, seed, spore, larva and gamete dispersal (v) Condition for germination (vi) Highly transparent; therefore allowing light to reach aquatic organisms, for photosynthesis; and aquatic predators to locate their prey (vii) Important factor in decay and decomposition ; therefore increases in recycling of nutrients in an ecosystem.</p> <p>(3) Air and wind: wind brings about changes in the weather and it directly affects the organisms. (i) wind enables seed and spore dispersal (ii)wind affects the rate of transpiration (iii) determines the distribution of many plant species (iv) Because of wind, plants have strong deep roots (v) Wind also enables mixing of nutrients and pollutants in water.</p> <p>(4) Humidity: affects transpiration rates in plants, number of stomata in the leaves and rate of evaporation in animals more so the small invertebrates like earth worms, snails hence distribution of plant and animal populations.</p> <p>(5) Temperature: (i) temperature is vital because it affects the enzymes in plants and animals (ii) temperature also enables fruit ripening (iii) transpiration rate, wilting of leaves. (iv) Low temperatures break dormancy of some plants (v) stimulate flowering in some plants e.g cabbage (Vernalisation) (vi) In animals it affects humidity and available water in the habitat which factors affect the distribution of organisms.</p>	<p>b. Edaphic factors</p> <p>These are soil factors such as;</p> <p>(1)Texture: This is the proportion of soil particles (sand, silt, clay). It influences the water holding capacity of the soil which in turn influences the number of individuals in a population since plants need water for growth.</p> <p>(2) Humus: These are the dead remains and decaying organic matter of living organisms. Humus acts as sponge in retaining water as so to reduce soil erosion, humus also holds soil particles together, further reducing on the rate of soil erosion. Humus decomposes to release minerals which add nutrients to the soil enabling the plant number to increase. Humus is a habitat for some soil organisms. Its dark colour retains heat in the ground.</p> <p>(3) Air: Oxygen is required by roots in the soil and most soil animals. Therefore well aerated soils support a number population/community. Water logged soils are due to compacted soil particles like clay has less air which leads to anaerobic conditions and hence cause death of most aerobic plants, animals and fungi hence reducing their population.</p> <p>(4) Water: Water is an important metabolic and a medium of transfer of gametes/dispersal of fruits/seeds thus its availability supports the growth of populations. This explains the presence of xerophytes and halophytes (normal soils) and hydrophytes (aquatic).</p> <p>(5) Mineral/inorganic salts: Different species of organisms (plants) require different mineral salts and their qualities and so the distribution and number of any population is pH influence the type of plants in a particular area. It also affects the physical properties and uptake of the mineral salts hence affects growth. Some plants require alkaline soils yet others acidic soils.</p> <p>(6) Soil organisms: These are the macro-organisms/population of organisms which influence aeration, drainage tunnels and also soften soil thus exposing the mineral content to plants. Saprophytes/bacteria/fungi break down plant tissue and dead animals to release humus or mineral salts. The symbiotic association in the soil such as root nodule bacteria and plant roots enable fixation of gases/nitrogen in the soil for proper plant growth.</p>
--	--

Other factors include:

- Man's activities like immigration, pollution, drainage.
- Predators.
- Accumulation of toxic substances.
- Epidemic out break/diseases.
- Migrations in and out.

c. Biotic factors (interactions within the population)

This is the way how organisms deal with each other in their habitats and the relationship influence their distribution and abundance in the habitat. The interactions could be positive or negative.

The negative interactions enable the growth rate of individuals affected by the presence of related organisms or species to decline as a result of over predation, competition, parasitism, symbiosis, mutualism, commensalism.

Population growth and survivorship curves

Population grows and declines in size. The size of population increase is determined by the reproductive potential of the concerned organism and by environmental resistance.

The biotic **potential/reproductive potential** is the maximum number of off springs that can be produced by a species under ideal conditions or is the rate of reproduction given unlimited environmental resources.

Factors affecting biotic potential	Factors hindering biotic potential
❖ Off spring; the maximum number of off springs per birth.	❖ Loss of food.
❖ Capacity for survival; the chances the organisms' off springs will reach reproductive age.	❖ Increased predator population.
❖ Procreation; the number of time per year the organisms reproduces.	❖ High pollution in the environment.
❖ Maturity; the age at which reproduction begins.	❖ Fire out break; destroys organisms, breeding sites, nest, eggs, slow moving organisms.
❖ Male to female ratios in the population.	❖ Man's activities of man e.g. encroaching on swamps, wet lands, forests, road construction(separates ecosystems)
❖ Age structure; age at which reproduction is high e.g. in man is 45, chances of producing become minimal.	❖ Diseases, parasites and pests

K and r population strategies

Most natural population fall between two extremes called r-selected and K-selected population as were used in the equation for population growth.

Note: r-species/r-strategists species produce rapidly and have a high value of r.

Characteristics of r-selected populations

- ❖ They are found in habitat/environments which undergo many changes.
- ❖ The individuals are small in size.
- ❖ Have a short life span i.e. they attain reproductive potential very early.
- ❖ Have a high mortality rate not density dependent.
- ❖ Reproduce at a high rate.
- ❖ Off springs grow rapidly with little parental care provided.
- ❖ Favourable conditions favour rapid explosion of population growth hence no or less competition. Thus selection pressure in such species favours high reproduction rate and short generation.
- ❖ A sudden environmental change results in a massive number of deaths. But their rapid birth rate and short life span favour the ability to adapt to a changing habitat e.g. insects, seeds, spores, bacteria, annual plants, paramecium.
- ❖ They are opportunist pioneer species of new and disturbed habitats. Migration and dispersal are key factors of their strategy.
- ❖

K-selected populations

These are associated with specific habitat conditions or fairly stable environmental conditions with fewer fluctuations, relatively undistributed habitats and even the changes of the seasons are regular and predictable and where competitive ability rather than reproductive speed is a major survival attribute/factor.

They tend to be more typical of the later stages of succession and such species are not very adapted to recover from population densities significantly below their equilibrium level (K-value or carrying capacity).

Characteristics of K-selected population

- ❖ Reproduce slowly (low fecundity, long generation time) therefore low value of r.
- ❖ Reproduction rate is sensitive to population density, rising rapidly if density falls.
- ❖ Population size stays close to equilibrium level determined by K.
- ❖ Species are persistent in a given area.
- ❖ Disperse slowly
- ❖ Large in size e.g. woody stems and large roots if plants.
- ❖ Individuals live long
- ❖ Habitats stable and long lived (forests for monkeys).
- ❖ Good competitors
- ❖ Many become dominant.
- ❖ Less resistant to changes in environmental conditions e.g. butterflies, birds, humans and trees.

Comparison between r-selected and K-selected (equilibria) populations

Characteristic	r-selected species	K-selected species
Body size	Small	Large
Lifespan	Short	Long
Competitive abilities	Poor	Good
Defensive strategies	Lacking	Well developed
Dispersal	Disperse or migrate widely and in large numbers	Disperse slowly. Species generally persistent in the habitat
Degree of specialisation to the habitat	Poorly specialised (more adaptable to changes in environmental conditions)	Highly specialised (less adaptable to changes in environmental conditions)
Age at first reproduction	Early	Late
Number of reproductions per life time	Usually one	Several
Number of offsprings per reproductive episode	Many; reproductive rate not sensitive to population density	Few; reproductive rate is density-dependent
Size of offspring/egg	Small	Large
Parental care	None	Extensive
Mortality rate	High	Low
Examples	Bacteria, aphids, flour beetles, annual plants, weeds, cockroaches	Humans, owls, large trees, whales, large marine birds

Survivorship curves

This is a graph that shows the proportion or numbers of individuals in a group will still be alive at a given age. For any population size to remain constant at least two off springs from each male and female pair on average must survive to reproductive age.

The percentage of individuals that die before reaching reproductive age, pre-reproductive mortality (infant mortality), is a major factor determining population size. Knowledge of survivorship enables ecologists to study population growth

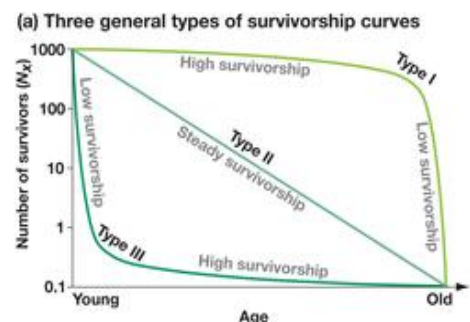

Survivorship curve & Typical examples of organisms	Explanation
Late loss curves (Type I) Humans, elephants, rhinoceroses, mountain sheep	<ul style="list-style-type: none"> • These are organisms with stable populations close to carrying capacity of the environment (K). • They produce few young ones which are cared for until reproductive age, thus reducing juvenile mortality and therefore enabling high survivorship to a certain age, then high mortality at later age in life.
Constant loss (Type II) Many song birds, lizards, small mammals and hydra	<ul style="list-style-type: none"> • This is characteristic of species with intermediate reproductive patterns with a fairly constant rate of mortality in all age classes and thus a steadily declining survivorship curve. • There is an equal chance of dying at all ages. • These organisms face a fairly constant threat from starvation, predation and disease throughout their lives.
Early loss curves (Type III) Most annual plants, most invertebrates and most bony fish species	<ul style="list-style-type: none"> • These are organisms with a high intrinsic rate of increase. • They produce many offspring which are poorly cared for resulting into high juvenile mortality. • There is high survivorship once the surviving young reach a certain age and size.
<p>Question: which population I and III would need the highest reproductive rate to maintain a stable population?</p> <p><i>It is population III because a high percentage of individuals would die before reproductive age is reached. Population I would have to combine its high survival rate with low reproductive rate to maintain a stable population size.</i></p>	
<p>Most populations have survivorship curves which are a combination of the three types. For example, herring gull starts out with survivorship type III (when newly-hatched chicks are most vulnerable) but once the chicks are independent, the survivorship curve resembles type I.</p>	

Determination of population size of organisms

Importance of estimating population size

- It enables monitoring of population growth.
- It enables determination of habitat requirements of a species.
- It enables determination of carrying capacity of the area i.e. to determine whether existing populations are likely to be sustainable
- It enables determination of age structure and sometimes sex ratio of the population.
- It enables projection of how population size is likely to change with time for proper planning e.g. determining the peak populations of pests enables control measures to be prepared.

Factors to consider before counting organisms

- The area of land or volume of water or air under study must be determined.
- The nature of vegetation cover of the habitat.
- Size of the organisms under study.
- Facilitation in terms of equipment to be used.
- Behaviour of the organisms e.g. their hostility and level of excitement when disturbed.
- Topography of the area.
- Whether the habitat is terrestrial or aquatic.
- Risks expected to be faced during the exercise.
- The duration the exercise is expected to last.

Methods of determining population size of organisms

<p>1. Total count/Census This is the physical counting of every individual of a population in a specified area of ground. Examples: a. census of people after every ten years b. aerial counting from a low flying aircraft of large, sessile, slow moving animals and mobile but large animals e.g. giraffes, elephants, lions, e.t.c. Accurate results obtained from conducting several aerial counts in the area and then the average is computed and expressed as numbers per unit area of ground.</p>	<p>2. Counting by sampling This is when the number of organisms is determined in several sample plots that represent a known fraction of the total area under investigation from which estimation of the total population size of the whole area is made by simple calculations. Sample counting is applied when the number of the organisms is large, covers a large area or where the behaviour of organisms does not allow easy contact.</p>
---	---

A survey of sampling methods

Quadrant

Quadrant sampling is suitable for slow moving animals and plants.

A metallic, plastic or wooden frame of known area e.g. 1m² or 0.25m² is randomly thrown several times in the area under investigation and all individuals within the quadrant are counted each time.

Population density is expressed as an average figure per metre squared. Total population is got by multiplying the average with the total area under investigation.

<p>Advantages: (1) The method is relatively accurate (2) It enables comparison of species density in different areas (3) It provides an absolute measure of abundance.</p>	<p>Example: Three counts of 103, 46 and 20 of a plant species, were made using a quadrant of 25cm². The population density of the plant per m² is? $\text{Population density} = \frac{103 + 46 + 20}{3} = 56.3$ 25cm² contain 56.3 ∴ 1cm² contains $\frac{56.3}{25}$ plants 100cm² contain $\frac{56.3}{25} \times 100 = 225$ plant</p>
<p>Disadvantages: It is: (1) time consuming (2) not suitable for fast moving animals (3) not suitable for large sized animals. (4) Grass in tussocks appear indistinguishable and may disturb.</p>	

Line transect

A line or string is laid along the ground in a straight line between two poles. Sampling is confined to only those organisms touching the line. Line transect is useful in studying transition of one community to another

Capture-recapture (Lincoln index) method

<p>This method is used on highly mobile animals like fish, small mammals e.g. rats, birds, and arthropods e.g. insects like butterflies, grasshoppers, cockroaches. It involves capturing and counting the organisms (N₁), marking them in a way that causes no harm, and returning them to the natural environment. After allowing sufficient time for the population to mix thoroughly, a second catch (N₂) is made and the number of marked individuals recaptured is recorded as N₃ Estimated total population (P) = $\frac{N_1 \times N_2}{N_3}$</p>	<p>Assumptions which the method bases on:</p> <ul style="list-style-type: none"> • That organisms mix randomly within the population. • That the time allowed for random mixing is enough. • That changes in population size due to immigration, emigration, death and birth are negligible. • That the movement of organisms is restricted geographically. • That there is even dispersing of organisms within the study area. • That the mark does not hinder the movement of the organisms or make them conspicuous to predators.
--	---

<p>Example: In estimating the number of fish in a small lake, 625 fish were caught, marked and released. After one week, 920 fish were caught and of these, 150 bore marks. What was the estimated size of fish population?</p> $P = \frac{N_1 \times N_2}{N_3}$ $P = \frac{625 \times 920}{150} = 3833$	<p>Disadvantages / Limitations:</p> <p>(1) It is only reliable when the organisms' range of movement is relatively restricted and defined (2) Animals often move in groups whose members recognise one another and avoid mixing with those of other groups (3) Many animals have particular localities (home ranges) where they confine, so the marked animals may not spread widely (4) Loss of marked individuals reduces those recaptured and this causes inaccuracy.</p>
---	---

QN. Suggest and describe the suitable methods for estimating the population size of the organisms below. Give reasons for your choice of each method and outline the associated limitations.

- Fish in a pond
- Terrestrial plants

Estimating population density

Population size can be estimated in various ways which include;

- a) Quadrat method
- b) Transect method
- c) Capture-mark release recapture method (the Lincoln index)

How population density affects population growth

- a) **Density-dependent population control;** involves factors whose effectiveness depends on the number of individuals present in a unit of space i.e. the more individuals there are in the population, the greater the percentage of the population that dies or fails to reproduce. Examples: Competition for resources like food, disease, predation, parasitism (biotic factors mainly)
- b) **Density-independent population control;** involves factors whose effectiveness is not related to the density of the population. Any change in the factor affects the same proportion of the population regardless of population density. Examples: temperature, rainfall, light, floods, soil nutrients, pollution, fires, drought, hurricanes, habitat destruction e.g. clearing a forest or filling in a wetland, pesticide spraying etc. (mainly abiotic factors)

Kinds of population change curves in nature

Causes and Examples

<p>a) Stable population growth curve: Trees in a tropical rain forest where there is little variation in temperature and rain fall from year to year.</p> <p>b) Irruptive population growth curve: Some algal populations in freshwater habitats, raccoon and feral house mouse. This is caused by some factor that temporarily increases the carrying capacity e.g. more food, favourable weather, or fewer predators.</p>	<p>c) Irregular population growth curve This is partly attributed to chaos in such systems but causes and interactions are not clearly understood.</p>
	<p>d) cyclic population growth curve Lemmings (small rodents whose populations rise and fall every 3-4 years), grouse, lynx and snowshoe hare (whose populations generally rise and fall on a 10-year cycle). The actual causes are poorly understood, although predators sometimes are blamed.</p>

Distribution of organisms (population dispersion)

Dispersion refers to the structure/distribution of individuals or organisms within an area

Dispersal is the movement of individuals/organisms or their seeds, parts into or out of the population or habitat to a different locality/area.

Importance of dispersion in animals

- ❖ Individuals acquire a home/nest/habitat within which they can live and breed.
- ❖ Individuals are spread out such that resources like food, breeding grounds become enough.
- ❖ Chances of obtaining a mate is increased since males attract females into their territories.
- ❖ Reduces distances moved away from home to search for food, mate, etc. this saves energy, time and prevents exposure to predators.

- ❖ New or depopulated areas are colonized.
- ❖ It increases the rate of gene exchange/gene mixing between populations via mating.
- ❖ It may prevent extinction and or speed up population growth.
- ❖ Natural barriers like rivers and rift valleys restrict animals in particular areas e.g. bush backs, chimps and elephants.

Dispersal mechanism of the population supplements natality and mortality in shaping population growth form and density.

There are 3 forms of dispersion:

1. Uniform/regular distribution

This occurs where intraspecific competition is severe. However, man artificially can induce it through agricultural practices e.g. planting of seeds or birds nesting on a small island

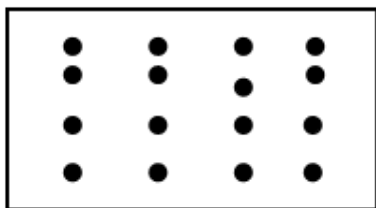

3. Random dispersion/distribution

This is relatively rare in nature. It occurs where the environment is very uniform in terms of resources and there is no tendency of organisms to aggregate. There is equal and even distribution of resources. There is low or no competition. For example herbaceous plants in a garden

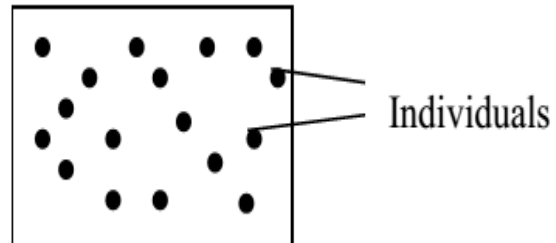

2 Clumped distribution/aggregate/clustered

It's the naturally occurring type of distribution where individuals tend to aggregate at a particular point on the habitat. It's due to; **Distribution of resources** that are not regularly distributed due to climate and soil factors.

Social behaviour like termites and bees have division of labour among members, animals that live in colonies like buffalos, baboons, monkeys, etc. clumps could be irregular or regularly distributed.

Regular pattern:

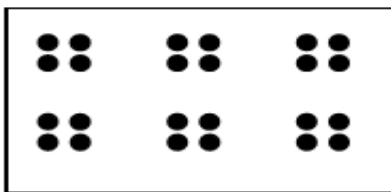

Irregular pattern or random:

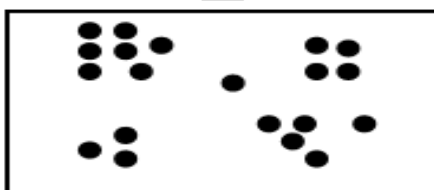

Many communities are dominated by clumped patterns of distribution for several reasons:

- i) Effects of parent plant i.e. seeds may not be dispersed far from the parent plant hence plant seedlings are usually found near the parent plant.
- ii) Distribution of environmental factors. These are not uniform for all areas.
- iii) Species interrelations i.e. a species may be depending on another directly e.g. epiphytes. Animals exhibit dispersion in form of territorial behaviours. A territory is a defined area owned by a group of animals/family and defended against other members of the same species.
- iv) Natural barriers like rivers and rift valley restrict animals in particular areas e.g. bush backs, chimps and elephant

4.0 INTERDEPENDENCE

Interaction within the populations

Competition

Within a population, individuals compete with each other for food, water, mineral salts, territory, shelter, mates, resting sites, etc. therefore competition is the interaction that occurs between two or more organisms, populations or species that share resources.

Types of competitions

1. Interspecific competition; is competition among individuals from other species for resources.
2. Intraspecific competition; is competition among individuals of the same species for essential resources.

The closer the ecological niches of the competing organism, the fiercer are the competition.

Co-existence between two species which compete is impossible. To avoid severe/stiff competition and extinction the two different species occupy different ecological niches. This is called *competitive exclusion principle*.

It states that, “no two organisms can occupy the same ecological niche when they compete for the same resources. If they did so, one would become extinct or will be out-competed thus becomes extinct.”

Organisms develop structural features and behavioral patterns to enable them succeed in the exploitation of natural resources.

The successful organism has a **faster rate of reproduction** and a **higher tolerance** to waste materials e.g. seedlings in forests show rapid growth due to competition to gain access to sunlight for photosynthesis.

Consequences of competition

- ❖ Weak competitors are eliminated or extinction of species or migration.
- ❖ It results in feeding habits/feed on food nutrients which they used not to feed on.
- ❖ It affects pollination between certain plants and specific insects.
- ❖ Gene loss or change in gene frequency.

The competitive exclusion principle (Gause's exclusion principle)

Two species (populations) that require identical resources cannot coexist indefinitely in the same habitat. G. F Gause (1932), a Russian microbiologist and ecologist was one of the first to make laboratory investigations on competitive systems

Experiments with Paramecia

Two closely related species of single-celled, *bacteria eating Paramecia* were grown, first separately and then together in culture tubes.

Lemna (duckweed) species also show similar results when grown in mixed cultures. The results of this classic experiment are reflected in the graphs below

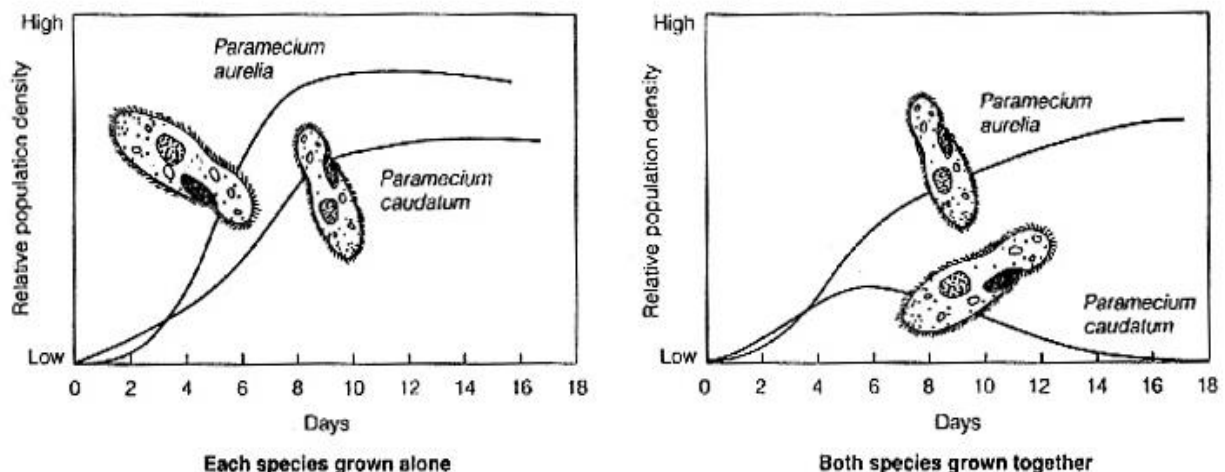

Figure 6-3 The results of G. F. Gause's classic laboratory experiment with two similar single-celled, bacteria-eating species of *Paramecium* (that reproduce asexually) support the competitive exclusion principle that similar species cannot indefinitely occupy the same ecological niche.

<p>The research revealed the following;</p> <ol style="list-style-type: none"> i. Pure population of <i>Paramecium caudatum</i> and <i>Paramecium aurelia</i> grown in full-strength concentration of food had a high carrying capacity (of 195). ii. Pure population of <i>Paramecium aurelia</i> grown in half-strength concentration of food had a low carrying capacity (of 105). iii. Pure population of <i>Paramecium caudatum</i> grown in half-strength concentration of food had a low carrying capacity (of 64). iv. Pure population of <i>Paramecium caudatum</i> grown in full-strength concentration of food showed a high carrying capacity (of 137) v. When grown together, <i>Paramecium aurelia</i> survived, while the population of <i>Paramecium caudatum</i> rapidly decreased. vi. At a full-strength food concentration, the decrease in the <i>Paramecium caudatum</i> population was approaching exclusion by 16 days but exclusion was not complete. vii. At half-strength food concentration, <i>Paramecium caudatum</i> had been entirely eliminated by day 16. 	<p>Other observations</p> <ol style="list-style-type: none"> i. The maximum population density of <i>P. aurelia</i> attained in separate cultures is higher than that of mixed cultures. ii. The rate of population density increase for both organisms is higher in separate cultures than in mixed cultures. iii. The initial population density of <i>P. aurelia</i> in both experiments is lower than that of <i>Paramecium caudatum</i>. iv. The decrease in population density of <i>P. caudatum</i> is very gradual in separate cultures in comparison with mixed culture. v. The population density of <i>P. caudatum</i> in mixed cultures decreases to extinction but that in separate culture remains higher even at carrying capacity. vi. <i>P. aurelia</i> out-multiplied and eliminated <i>P. caudatum</i> when grown together.
Observations	Explanations
Experiment; each species grown alone	
<p>Population density of <i>Paramecium Aurelia</i></p> <ul style="list-style-type: none"> • Increases very gradually for the first 2 days, very rapidly to a maximum on the 9th day, remains relatively constant till the 12th day, then decreases very gradually thereafter. • Grew faster than that of <i>Paramecium caudatum</i> 	<p>There is rapid growth of population densities of both organisms because of:</p> <ol style="list-style-type: none"> i. Abundance of food. ii. Absence of interspecific competition for food.
<p>Population density of <i>Paramecium caudatum</i>:</p> <ul style="list-style-type: none"> • Increases gradually but later increases rapidly for the first 9 days, increases very gradually till the 14th day and then declines very gradually thereafter. • Increase less rapidly when compared with <i>P. aurelia</i>. • Remains lower than that of <i>P. aurelia</i>, except for the first three days. 	<p>Stable populations are established afterwards for both organisms because of intraspecific competition for food.</p> <p>Population density of <i>P. aurelia</i> grew faster than that of <i>P. caudatum</i> because the former used the available food supply more efficiently than the latter.</p>
Experiment; Species in mixed culture	
<p>Population density of <i>Paramecium aurelia</i>:</p> <ul style="list-style-type: none"> • It is lower than that of <i>P. caudatum</i> for the first 3½ days. • Increases gradually for the first two days, very rapidly till day 7 and then gradually thereafter. <p>Population density of <i>Paramecium caudatum</i>:</p> <ul style="list-style-type: none"> • Remains higher than that of <i>P. aurelia</i> for the first 3½ days only. • Increases rapidly to a maximum in the first 5½ days, decreases gradually till day 15, and more gradually to extinction at day 17. 	<p>The population density of <i>P. caudatum</i> decreased to extinction because of being out-multiplied and outcompeted for food by <i>P. aurelia</i>. This is attributed to the smaller size of <i>P. aurelia</i>.</p>

How species reduce or avoid competition through resource partitioning

Resource partitioning is the dividing up of scarce resources so that species with similar needs use them (i) at different times (ii) in different ways or (iii) in different places.

Over a time scale long enough for evolution to occur, some species that are in competition for the same

resources evolve adaptations that reduce or avoid competition or an overlap of their fundamental niches. Resource partitioning decreases competition between two species leading to increased niche specialisation

Examples of resource partitioning

- i. When living in the same area, lions prey mostly on larger animals while leopards on smaller ones.
- ii. Hawks and owls feed on similar prey, but hawks hunt during the day and owls hunt at night.
- iii. Each of the five species of common warblers (insect-eating birds) minimises competition with the others by;
 - a) spending atleast half its feeding time in a different part of spruce tree branches e.g. some hunt at the extreme top, others at the lower portion, some mid-way e.t.c
 - b) Consuming somewhat different insect species.
- iv. Different species of eagles in a forest feed at different times of the day e.g. bald headed eagles are most active early mornings and evenings while the white-breasted eagles feed vigorously towards noon.
- v. *Paramecium aurelia* and *paramecium bursaria* can coexist in a tube containing yeast because the former feeds on yeast suspension in the upper layers of the fluid whereas the latter feeds on the bottom layers.
- vi. When three species of ground finches of Galapagos Islands occur on separate islands, their bills tend to be the same intermediate size, enabling each to feed on a wider range of seeds, but where they co-occur, there is divergence in beak size to suit each finch species to feeding on seeds of either small, medium or large size, but not all sizes.
- vii. Various bird species in a coastal wetland feed in different ways e.g. flamingos feed on tiny mud organisms, brown pelicans form air dives for fish, herons wade into water to seize small fish, herring gulls are tireless scavengers, piping plovers feed on insects and tiny crustaceans on sandy beaches.
- viii. In an abandoned field, drought tolerant grasses with shallow, fibrous root system grow near the soil surface to absorb moisture; plants with a taproot system grow in deeper soil while those with a taproot system that even branches to the topsoil and below the roots of other species grow where soil is continuously moist.
- ix. Two species of barnacles do not occupy as much area of the intertidal zone as possible. The upper intertidal zone is the realised niche of the smaller barnacle *Chthamalus stellatus* since it is drought resistant while the larger *Balanus balanoides* being poorly adapted to drought lives on the lower intertidal zone. Interestingly, *C. stellatus* can also grow very well in the lower zone only in the absence of *B. balanoides*, suggesting that *Balanus* barnacles when present either forces the smaller *Chthamalus* individuals off the rocks or grows over them. This indicates that the entire intertidal zone is the fundamental niche of *Chthamalus*, but competition for space restricts it to the upper intertidal zone.

Note:

- a) The more two species in the same habitat differ in their use of resources, the more likely they can coexist.
- b) Two competing species also may coexist by sharing the same resource in different ways or at different times
- c) The tendency for characteristics to be more divergent when populations belong to the same community than when they are isolated is termed character displacement.

Predation

Predation is a feeding relationship where one organism of a given species, the predator, hunt, kill and feeds on another, the prey of another species.

The growth and decline of the population of such organisms depend on the number of each group in an ecosystem. Initially prey population grows at a faster rate than the predator. The predators feed on the prey, thus increasing in production.

A reduced prey population triggers off competition for density dependent factors like food, space, mates among the increased predator population and also increased accumulation of wastes. These will check the increase in predator population hence predator number will start to decrease in number due to starvation.

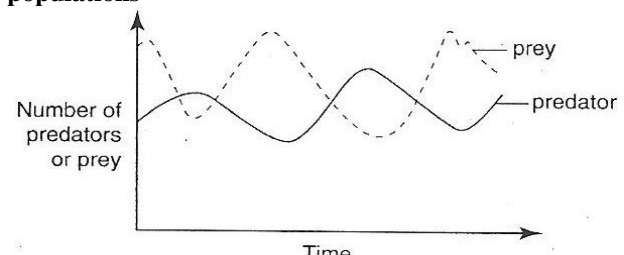
<p>When predator populations decrease, prey will reproduce and multiply in number and increase. Therefore, large numbers of preys provide food and therefore food becomes available. Thus the population of prey and predator affects each other which bring about fluctuation in the growth of their populations. Note: normally the numbers of predators tend to lag behind than those of prey because predators being larger have a slower rate of increase.</p>	<p>Graph showing relationship between predator-prey populations</p> 
---	---

Importance of predation

- Predation maintains populations within the carrying capacity of their habitats and lessens the sudden explosion of prey species within a population.
- Predation is a mechanism by which excess animal productivity is re distributed by conversion to other animal tissues at higher trophic levels.

Examples

- The graph below show the relationship between a predator, *Didinium* and prey, *paramecium* in a culture medium.

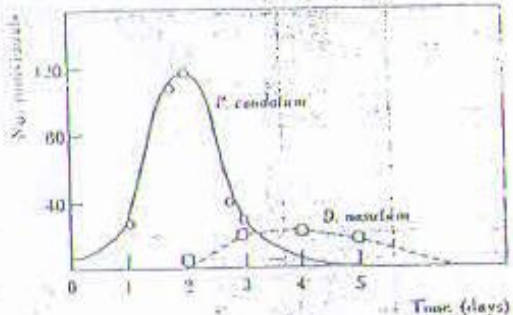
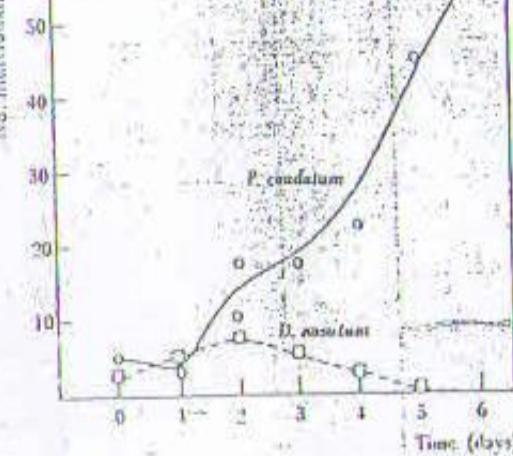
	<p>Description of the trend for;</p> <ul style="list-style-type: none"> Paramecium From 0 days to 1 days the <i>Paramecium</i> population increases gradually. From 1 day to 2 days the <i>Paramecium</i> population increases rapidly to a maximum. From 2 days to 3 days the <i>Paramecium</i> population decreases rapidly From 3 days to 4½ days the <i>Paramecium</i> population gradually decreases up to 0 Didinium From 2 days to 3 days the population of <i>Didinium</i> increases gradually From 3 days to 5 days, the population <i>Didinium</i> remains almost constant From 5 days to 6 days the population of <i>Didinium</i> gradually decreases up
	<p>Description of the number of individuals for:</p> <p>From 0 days to 1 day the <i>Paramecium</i> population decreases from 1 day to 5½ days the <i>Paramecium</i> population increases to a maximum. From 0 days to 2 days the <i>Didinium</i> population increases to a peak From 2 days to 5 days the <i>Didinium</i> population decreases to a extinction</p> <p>Explanation Both <i>Paramecium</i> and <i>Didinium</i> were introduced on same day in an oat medium with sediment in which some, but not all of the <i>Paramecium</i> hid from the predator. The <i>Paramecium</i> population slightly higher than that of <i>Didinium</i>.</p>
<p>Explanation. <i>Paramecium</i> population decreases for the first day because all of it that was in the clear-fluid medium was preyed upon by <i>Didinium</i>, which increases and later starves to death. The increase in <i>Paramecium</i> population is because of its emergency from the sediment after death of the <i>Didinium</i></p>	

How predators are suited for capturing prey

- i) Herbivores simply walk, swim, or fly up to the plants they feed on.
- ii) Some carnivore like cheetah and lions have muscular limbs for running very fast to catch prey.
- iii) Other carnivores like bald eagles, hawks, lions e.t.c. have keen eyesight for locating prey.
- iv) Carnivores like wolves and African lions cooperate in capturing prey by hunting in packs.
- v) Other predators have characteristics that enable them to hide and ambush their prey e.g. praying mantises sit in flowers of similar colour and ambush insects, alligators lie at stream bottom and dangle worm-like tongue to entice fish into its powerful jaws, a chameleon has a cryptic colouration that enables walk to prey unnoticed.
- vi) Some predators have a highly developed sense of smell for locating prey e.g. meerkat locates insects by smelling.
- vii) Some nocturnal predators like bats and owls have a highly developed sense of detecting sound made by prey.
- viii) Electric fishes such as *Malapterurus* (cat fish) and electric rays produce high voltage discharge of up to 350v that stun their prey while the electric fish *Gymnarchus* produces a low electric potential of less than 0.1v to detect prey.
- ix) Web-spinning spiders use their silky webs to catch small sized ground walking or flying insects.
- x) Ant-lions (lacewing fly larvae) lay traps by making pits in the ground where preys fall.
- xi) Some snakes e.g. puff adder, cobra, Naja and mamba, *Dendroaspis* have glands that secrete poison (venom), which the fangs inject into the prey to immobilise it.

How prey are suited for avoiding predation (strategies of protection by prey against predation):

- i) Ability to run, swim or fly fast.
- ii) Possession of highly developed sense of sight or smell for alerting the presence of predators.
- iii) Possession of protective shells e.g. turtles and snails for rolling into armour-plated ball
- iv) Possession of spines (porcupines) or thorns (cacti and rose-bushes) for pricking predators.
- v) In some lizards tails break off when attacked, giving the animal enough time to escape.
- vi) Some prey camouflage by changing colour e.g. chameleon and cuttlefish, or having deceptive colours that blend with the background e.g. arctic hare in its winter fur blends into snow.
- vii) Some prey species discourage predators with chemicals that are poisonous (e.g. oleander plants), irritating (e.g. bombardier beetles), foul smelling (e.g. stinkbugs and skunk cabbages) or bad tasting (e.g. monarch butterflies and buttercups)
- viii) Some prey species have evolved warning colouration – contrasting pattern of advertising colours that enable predators to recognise and avoid such prey e.g. the poisonous frogs, some snakes, monarch butterflies and some grasshoppers.
- ix) Some species gain protection to avoid predation by mimicking (looking and acting like) other species that are distasteful to the predator e.g. the non-poisonous viceroy butterfly mimics the poisonous monarch butterfly. **Batesian mimicry** occurs when the palatable species mimics other distasteful species viceroy butterfly mimics the poisonous monarch butterfly, the harmless hoverfly mimics the painful stinging wasp while **Mullerian mimicry** occurs when both the mimic and mimicked are unpalatable or dangerous e.g. the five spot Burnet and related moths.
- x) Other preys gain some protection by living in large groups e.g. schools of fish, herd of antelope, flocks of birds.
- xi) Some prey scare predators by puffing up e.g. blowfish, or spreading wings e.g. peacock.
- xii) Coiling as seen in millipedes

Note: Plants have poor hosts for invertebrate parasites because;

- plants have strong cellulose cell walls so that are too difficult to be penetrated by parasites as invertebrate parasites lack cellulose enzyme to dissolve such walls

- plants store insoluble food that is undigested e.g. starch yet invertebrates absorb already digested food and so cannot provide suitable conditions for survival
- plants do not locomote to spread the parasites to other hosts
- plants have limited cavities where the parasites can be sheltered against climatic extremes
- some plants are seasonal which limits the dependence of parasites on them

Note: Benefits of predator-prey relationships to both the prey and the predator

- maintains both populations at carrying capacity as they regulate their number interdependently
- They eliminate the weak and aged predators and preys thereby maintaining a healthy populations
- They allow evolution of better adapted predators and preys via natural selection
- They allow nutrient cycling and energy flow
- These relationships avail resources to both predators and preys by maintaining carrying capacity

Note: precautions taken before the predator is introduced in an area

- Careful matching of climatic conditions to ensure that they favour the survival of the predator especially when the prey population is at the peak
- Monitoring of interactions of the natural enemy with native species to ensure that the predator is not preyed upon by other unsuspected organisms. This also allows identification of the prey organisms which may be presented by the predator instead of the targeted prey
- The predators must be released when the prey populations have reached large numbers to provide sufficient food for the predators. Otherwise the predator may get wiped out prematurely via starvation resulting into resurgence of the prey population.

Parasitism

An organism called **parasite** obtains part or all its nutrients from the body of another organism of different species called **host**. The parasite is usually smaller than its host in size. Parasites do not usually kill their hosts, but the host suffers harm. Many parasites live permanently on (ectoparasites) or in their hosts (endoparasites) while some visit their hosts only to feed. Some parasites are **facultative**, live on or in the host for some time e.g. *Pythium* (a fungus) that causes damping off seedlings, on killing the seedlings, lives as a saprophyte on their dead remains and others are **obligate** (live in or on the parasite for their entire time).

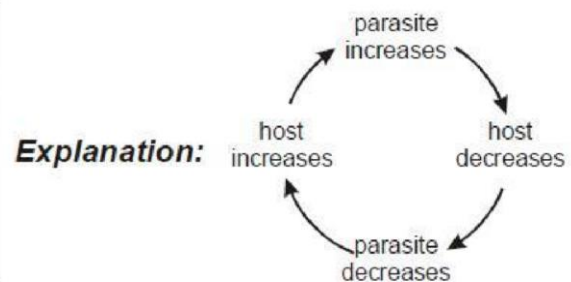
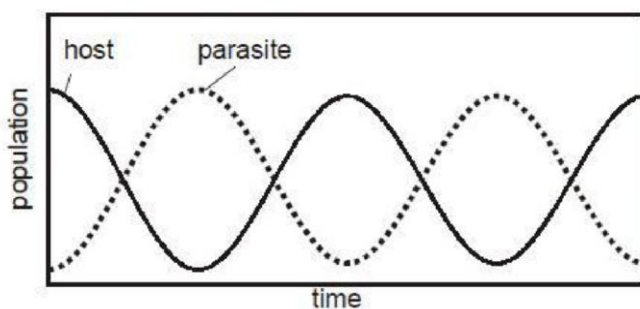

Note: In most cases, the parasites don't directly kill the host. However, by weakening its host, a parasite rises the host's susceptibility to other forms of environmental characteristics e.g. a severe fall in temperature during winter is more likely to kill parasitized organisms than healthy one, and a predator is more likely to catch parasitized animal than a healthy one.

Parasites which are introduced into a new habitat can cause disastrous effects on their host population e.g they can cause death on the host organism. However, given time, the relationship between a parasite and its host

evolves to minimize the harm to the host e.g. when the myxomatosis virus was introduced into Australia, all rabbits died in a short time of infection; however, after some time, infected rabbits were found to survive longer.

5.0 EFFECTS OF HUMAN ACTIVITIES ON ECOSYSTEMS

POLLUTION

It is the release of substances or energy into the external environment in such quantities and for such duration that they cause harm to living organisms or their environment.

Pollutants include noise, heat and radiation as different forms of energy, many chemical compounds and elements and excretory products.

The parts of the external environment affected include air, water and land.

Harm caused by pollutants

- Disruption of life support systems for living organisms
- Damage to wildlife, human health and property.
- Nuisances such as noise and unpleasant smells, tastes and sights

Categorization of pollutants basing on their persistence in the environment

a) Degradable (non-persistent) pollutants:

These are pollutants that are broken down completely or reduced to acceptable levels by natural physical, chemical and biological processes.

Biodegradation is the breakdown of complex chemical pollutants into simpler chemicals by living organisms (usually specialised bacteria) e.g. sewage is a biodegradable pollutant.

b) Slowly degradable (persistent pollutants):

Are those that take a longer time to degrade e.g. DDT - an insecticide, and plastics.

c) Non-degradable pollutants:

These cannot be broken down by natural processes e.g. the toxic elements lead, mercury, arsenic, selenium

AIR POLLUTION

Pollutant and its sources	Effects on living organisms	Control measures
Carbon monoxide [CO] <ul style="list-style-type: none"> • Motor vehicle exhausts • Incomplete combustion of fossil fuels • tobacco smoking 	i) Prevents oxygen usage by blood by forming carboxy-haemoglobin, which may cause death. ii) Small concentrations cause dizziness and headache	i) Efficient combustion of fuels in industry and homes ii) Avoid smoking. iii) Vehicle exhausts gas control e.g. in USA.
Sulphur dioxide [SO₂] Combustion of Sulphur containing fuels, oil, coal gas	i) Causes lung diseases, irritation of eye surface, and asthma resulting into death if in high concentrations. ii) Forms acid rain which increases soil PH. iii) Reduces growth of plants and kills lichens. Lichens are indicator species for SO ₂ pollution. The presence of many lichen species indicates low level of SO ₂ pollution in that area.	i) Use of Sulphur free fuel e.g. natural gas. ii) Installation of SO ₂ extraction units in industrial flues and chimneys.
Ozone, O₃ <ul style="list-style-type: none"> • Motor vehicle exhausts • combustion of fossil fuels to form nitrogen dioxide which decomposes to form oxygen atoms that combine 	<u>Low level</u> (tropospheric) ozone causes i) Internal damage to leaves hence reducing photosynthesis. ii) Eye, throat and lung irritation which may result into death. iii) Greenhouse effect by absorbing and radiating heat which raises the temperature at the earth's surface.	Vehicle exhausts gas control e.g. in USA.

with oxygen molecules to form ozone	High level (stratospheric) ozone offers protection against excessive solar heat by absorbing solar ultraviolet radiation which would reach the earth's surface	
Smoke i) House coal, smoke, soot ii) Motor vehicle exhausts iii) Tobacco smoking iv) Incomplete combustion of refuse in incinerators and bonfires	i) Causes lung diseases when inhaled ii) Sunlight barrier, hence reducing photosynthesis. iii) Stunted growth of plants iv) Stomatal blockage hence reducing photosynthesis.	i) Usage of smokeless fuels ii) Efficient combustion iii) No smoking iv) Vehicle exhausts gas control
Dust Solid fuel ash, soil, quarrying, mining, e.t.c.	i) Lung diseases ii) stomatal blockage iii) Stunted growth of plants. iv) Smog – forms when temperature inversion occurs (layer of warm air traps cool air containing dust and smoke close to the earth's surface)	i) Installation of dust precipitators in industrial chimneys. ii) Efficient combustion. iii) Wearing of face masks by factory workers.
Carbondioxide [CO₂] i) Motor vehicle exhausts ii) combustion of fossil fuels	i) Causes Greenhouse effect ; warming up of the earth's atmosphere as a result of the blanket of some atmospheric gases e.g. CO ₂ preventing escape of solar radiation higher into space. ii) Increased atmospheric CO ₂ levels results in global warming – the observed average global temperature rise of 0.8°C since 1900	Planting more green plants, reduction in combustion of fossil fuels by relying on alternative sources of energy e.g. solar energy
Nitrogen oxides Car exhaust emissions and industrial flue gases	Acid rain formation, contribute to greenhouse effect.	Car exhaust control
Chlorofluorocarbons [CFCs] Aerosol propellants, refrigerator and air conditioner coolants, expanded plastics. E.g. bubbles in plastic foam used for insulation and packaging	Enters stratosphere, the chlorine reacts with ozone hence reducing the ozone layer and permitting greater penetration of UV light to cause global warming.	Ban on the use of CFCs
Noise Discos, road traffic, engines, machines, aeroplanes, firearms	Hearing impairment, total deafness, and nervous disorders.	Effect laws against excessive noise, put on ear muffs and plugs while in industry.
Radioactive fallout from explosion Nuclear weapons and nuclear power fuels	Ionizing radiation causes cancer	Nuclear power controls

GREEN HOUSE EFFECT AND GLOBAL WARMING

Greenhouse effect

This is a description of the condition which results when greenhouse gases i.e. gases in the troposphere (atmosphere's inner most layer extending about 17km above sea level) like **carbon dioxide**, water vapour, **methane** and nitrous oxide allow mostly visible light, some infrared radiation and ultraviolet radiation from the sun to pass through the troposphere to the earth, which transforms this solar energy to longer-wavelengths - infrared radiation (heat), which then rises into the troposphere. Molecules of greenhouse gases absorb and

emit this heat into the troposphere as even longer-wave length infrared radiation, which causes a warming effect of the earth's surface and air. The tropospheric gases act like a glass of large green house surrounding the earth.

Global warming

This is the observed average global temperature rise of 0.8°C since 1900 as a result of the enhanced natural greenhouse effect.

Origins/sources of greenhouse gases	Effects of global warming
<ul style="list-style-type: none"> i) combustion of fossil fuels by motor engines and industries releases carbondioxide and methane into the troposphere ii) deforestation and clearing of grasslands reduces the uptake of carbondioxide in photosynthesis iii) ruminant fermentation produces methane, which is released into the troposphere iv) use of aerosol propellants, which contain CFCs that are 105 times worse than carbondioxide as greenhouse gases v) cultivation of rice in swamps and paddy fields causes anaerobic fermentation , which produces methane vi) use of inorganic fertilisers causes the release of nitrous oxide 	<ul style="list-style-type: none"> i) Rise in sea level due to melting of polar ice and thermal expansion of seas. ii) Altered temperature gradients cause cyclones and heavy rains as water evaporates quicker. iii) Species migrations which are likely to cause pests/diseases to extend their ranges. iv) Reduced crop yields due to drier weather. v) Increased crop yields because of more rainfall and longer growing seasons in some regions. vi) Flooding low-lying islands and coastal cities. vii) Extinction of some animal and plant species. viii) Increased death of the human population. ix) Greatly increased wild fires in areas where the climate becomes drier.

ACID RAIN

Formation

Combustion of fossil fuels releases **sulphurdioxide** and **nitrogen oxides** into the atmosphere. Catalysed by ammonia and unburnt hydrocarbons, these oxides react with water in the clouds to form solutions of sulphuric acid and nitric acid, which make up acid rain.

Effects

- i) Hydrogen ions bound to soil particles are displaced into runoff water by the SO_4^{2-} ions from sulphuric acid, causing formation of soft exoskeletons, which results into death of invertebrates
- ii) Aluminium ions are displaced from soil by SO_4^{2-} ions into water where it interferes with gill functioning in fish causing their death.
- iii) Aluminium ions displaced from soil by SO_4^{2-} ions into water are toxic when absorbed by plants
- iv) The leaching action of acid rain removes calcium and magnesium ions from soil causing poor formation of middle lamella and chlorophyll in leaves.
- v) Contributes to human respiratory diseases such as bronchitis and asthma.
- vi) Can leach toxic metals such as lead and copper from water pipes into drinking water.
- vii) Damages statues and buildings
- viii) Decreases atmospheric visibility, mostly because of sulphate particles
- ix) Promotes the growth of acid-loving mosses that can kill trees.
- x) Loss of fish populations when the PH lowers blow 4.5

Prevention

- i) Installation of SO_2 extraction units (wet scrubbers) in chimneys of industries.
- ii) Cleaning up exhaust emissions by encouraging several pollutants to react with one another to give less harmful products in catalytic converters.
- iii) Reduce coal use.
- iv) Increase use of renewable resources.
- v) Tax emissions of Sulphurdioxide i.e. "Polluter pays principle" should be adopted everywhere

Why high-altitude lakes quickly become acidic than low-altitude lakes?

Low-altitude lakes are richer than high-altitude lakes in limestone which buffers against the effects of acid rain, and also the surrounding soils to low-altitude lakes are deeper.

MAJOR CATEGORIES OF WATER POLLUTION

A) Sewage discharge into rivers

Sewage is liquid waste (composed of faeces, urine, water, detergents and other substances) from industries and or homes carried through pipes called sewers.

Effects of sewage discharge into rivers - changes in abiotic (a and b) and biotic (c and d) conditions

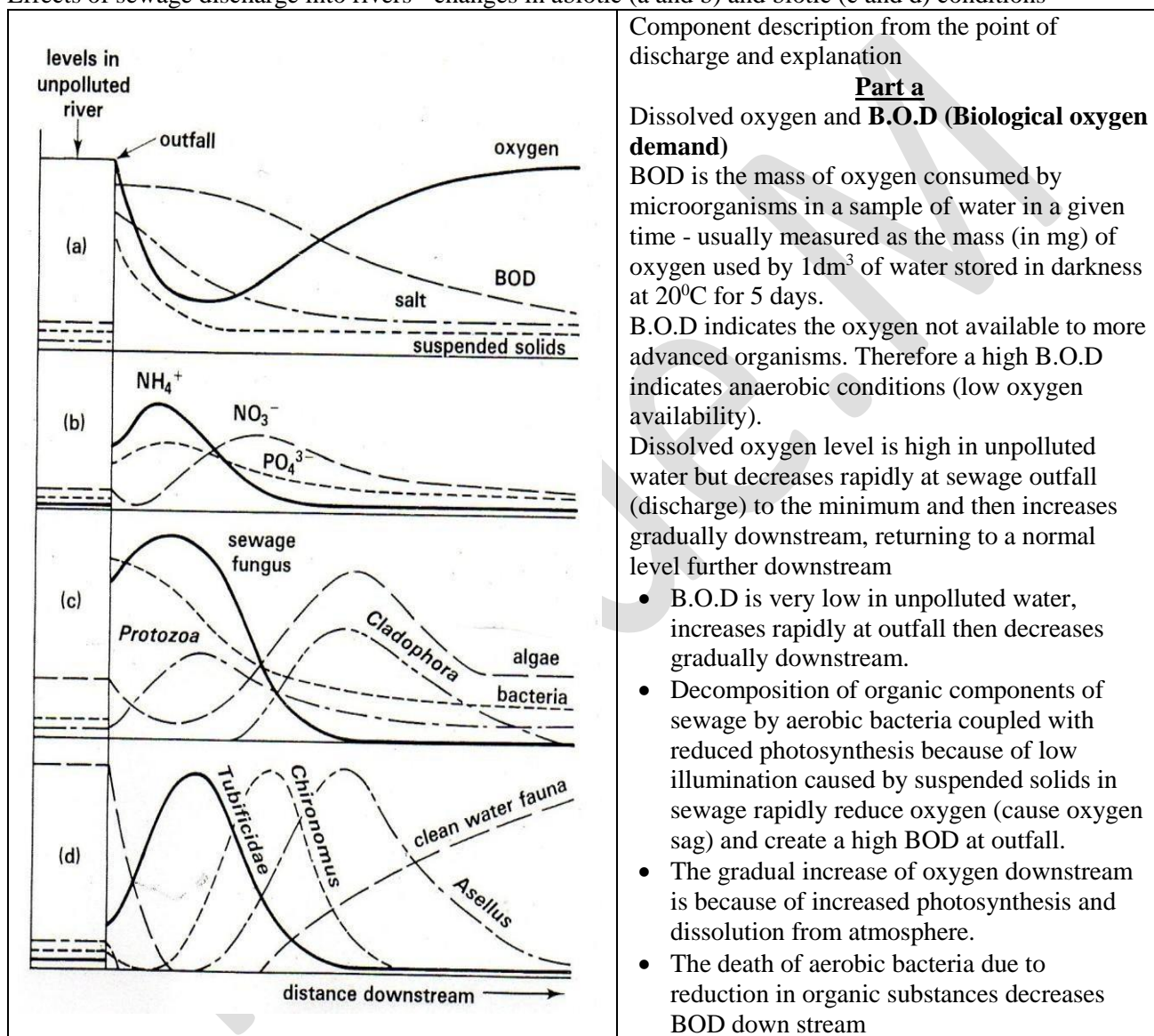

Suspended solids

- Suspended solids are very few before outfall, increase rapidly at the sewage discharge but progressively decrease downstream
- Sewage discharge adds decomposable organic matter into the water at the point of discharge, the progressive decrease downstream is due to bacterial consumption and dilution by water.

Part b

NH₄⁺, NO₃⁻ and PO₄³⁻ (Ammonium, nitrate and phosphate ions)

- NH₄⁺, NO₃⁻ and PO₄³⁻ ion concentration is very low before outfall

- NH_4^+ ions increase rapidly at discharge, then very rapidly to a maximum just after outfall, then decreases first rapidly and later gradually to a very low level downstream.
- NO_3^- ions first decrease gradually to a minimum concentration after outfall, gradually increase to a maximum a short distance downstream, then decreases gradually further downstream.
- PO_4^{3-} ion concentration increases (1) rapidly at discharge, (2) gradually just after outfall to a maximum, then decreases gradually to a very low level downstream.
- ❖ Sewage contains NH_4^+ ions. Putrefying (ammonifying) bacteria convert organic nitrogen-containing compounds in sewage to NH_4^+ just after outfall. Downstream, NH_4^+ ions are converted to NO_3^- by nitrifying bacteria and further downstream there is dilution by water.
- ❖ NO_3^- ions first decrease due to consumption by sewage fungus abundant at outfall, then gradually increase because NH_4^+ ions are converted to NO_3^- by nitrifying bacteria, then decrease gradually due to consumption by plants and algae.
- ❖ Sewage contains PO_4^{3-} ions from (1) detergents and (2) decomposition of organic matter, yet the consumption by autotrophs is very low at outfall, accounting for the high PO_4^{3-} ion concentration.
- ❖ PO_4^{3-} ion gradual decline downstream is caused by (1) absorption by the progressively increasing populations of autotrophs (2) storage in sediments.

3 INTRODUCTION TO ECOLOGY

Figure 3.23 Aspects of the pollution of a river by raw sewage: **a** and **b** physical and chemical changes to river water below a sewage outfall; **c** changes to microorganisms, protoctista and fungi; **d** changes to animals

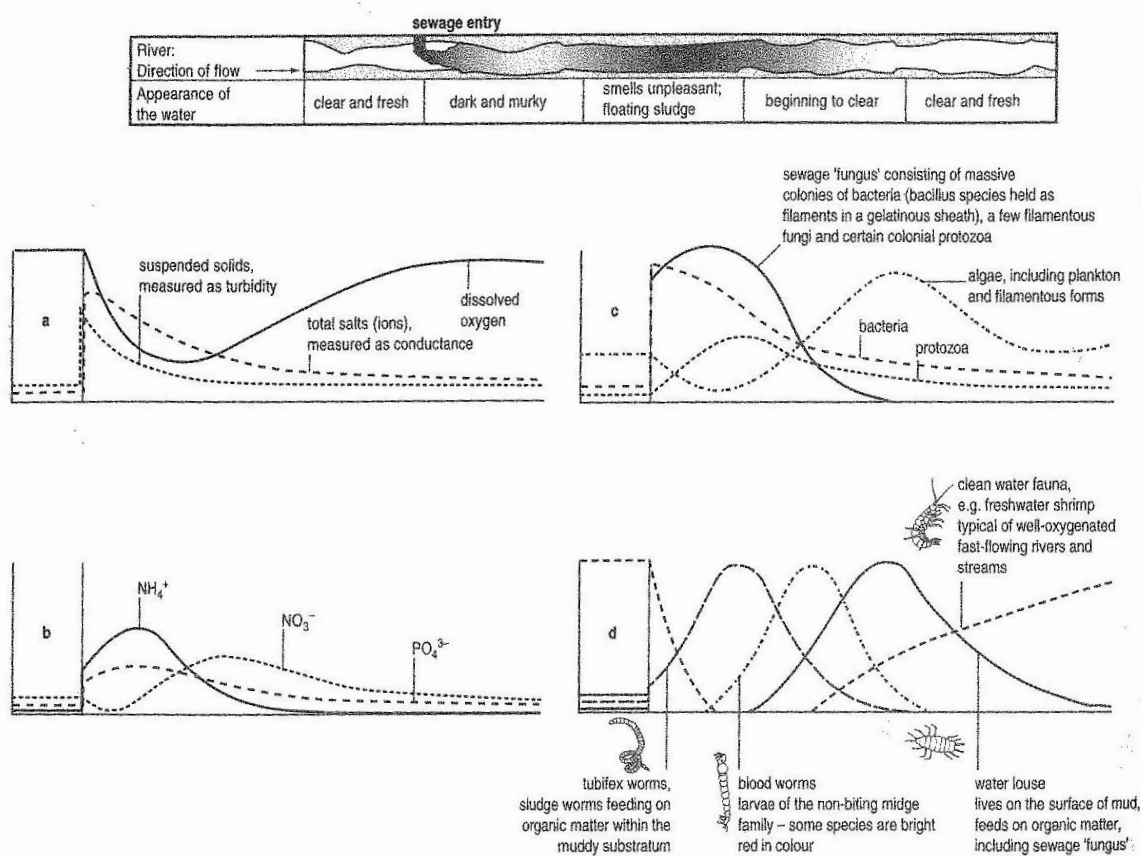

❖

Part c

Aerobic bacteria, sewage fungus, algae and higher plants

- Aerobic bacteria are very few before, but very many at outfall, then their population decreases rapidly immediately and gradually after out fall downstream.

- Sewage fungus is contained in sewage population, increases to a maximum immediately after outfall, but decreases rapidly downstream to very low level.
- Algae and higher plant populations decrease rapidly to a minimum at outfall but increase rapidly a short distance downstream and return to normal further downstream.
- Sewage contains aerobic bacteria that feed on organic substances, but population falls as availability of oxygen and nutrients diminishes.
- Population increases at outfall because the sewage fungus thrives in anaerobic conditions and is very tolerant of high ammonia concentrations.
- The rapid decrease in populations results from reduced photosynthesis because of the turbidity caused by suspended solids, the rapid increase is because of the high concentrations of NO_3^- (nitrate) ions and increased illumination because suspended solids reduce and water becomes clearer.

Part d

Clean water fauna (e.g. stonefly nymphs, may fly larvae, perch, trout), Asellus (fresh water louse), Chironomus (bloodworm), rat tailed maggot and Tubifex

(not indicated on the graph but it can be sketched basing on tolerance to pollution)

- The populations of clean water fauna are high before outfall, decrease rapidly to zero at outfall only appearing and increasing to normal with distance downstream.
- Asellus population decreases rapidly to zero at outfall, only appearing and increasing rapidly to a maximum a short distance downstream after which it decreases rapidly.

Tubifex population increases rapidly to a maximum at outfall and then decreases rapidly downstream. Rat tailed maggots' population increases rapidly to a maximum a short distance after outfall and then decreases rapidly downstream and Chironomus population increases rapidly to a maximum at a slightly longer distance from outfall and then decreases rapidly downstream.

- Clean water species cannot tolerate anaerobic conditions at outfall, populations increase downstream because oxygen and food become available.
- Asellus cannot tolerate anaerobic conditions at outfall and therefore dies and/or migrates to the relatively less polluted water downstream where it thrives. The decrease thereafter is due to consumption.

Tubifex, rat tailed maggots and Chironomus are (i) relatively inactive to reduce oxygen demand and (ii) have respiratory pigments with very high affinity for oxygen enabling them to be tolerant to anaerobic conditions. The increase in their population downstream indicates the level of pollution in the water. Tubifex, is the most tolerant to anaerobic conditions, followed by rat tailed maggots and Chironomus. The decrease in population downstream is partly due to predation.

Note:

Flowing rivers naturally undergo self-purification to recover from pollution through a combination of dilution and biodegradation, but the recovery time and distance depend on;

- volume of incoming degradable wastes in sewage
- flow rate of the river
- temperature of the water
- PH level of the water

Addition of inorganic chemicals, plant nutrients and sediments into lakes

Pollutant	Examples	Main human sources	Harmful effects
Plant nutrients	Nitrate (NO_3^-), phosphate (PO_4^{3-}) and ammonium (NH_4^+) ions. The nutrient enrichment of water bodies is	Raw sewage discharge, detergents and other chemical release from industries, leaching of	(1) Rapid growth of algae and green protists (algal blooming) (2) reduces light penetration in water leading to (3) Death and decay of algae, which depletes water of dissolved oxygen, killing fish and other aerobic animals. (4) Excessive levels of NO_3^- if drunk in water lowers the oxygen carrying

	termed eutrophication	inorganic fertilizers e.g. NPK from farmland.	capacity of blood and kills unborn children and infants (“blue baby syndrome”)
Sediment	(1) soil (2) silt	Land erosion	(1) cause turbidity / cloudiness in water and reduce photosynthesis, (2) settle and destroy feeding and spawning grounds of fish, (3) clog and fill water bodies, shortening their lifespan (4) disrupt aquatic ecosystems (5) carry pesticides, bacteria and other harmful substances into water.
Inorganic chemicals	Acids, compounds of toxic metals like lead (Pb), mercury (Hg), arsenic (As) and selenium (Se) and (3) salts e.g. NaCl in ocean water	Surface runoff, industrial effluents and household cleaners.	(1) Drinking water becomes unusable for drinking and irrigation (2) Lead and Arsenic damage the nervous system, liver and kidneys (3) they harm fish and other aquatic life (4) they lower crop yields (5) they accelerate corrosion of metals exposed to such water.

Heat (thermal) pollution:

Main human sources

Water cooling of electric power plants and some types of industrial plants

Harmful effects

- 1) Lowers dissolved oxygen levels since solubility of most gases reduces with temperature.
- 2) Makes aquatic organisms more vulnerable to disease, parasites, and toxic chemicals
- 3) When a power plant shuts down for repair or opens, fish and other aquatic organisms adapted to a particular temperature range can be killed by the abrupt change in water temperature. This is known as **thermal shock**.
- 4) Some aquatic animals may migrate to waters with favourable temperature.

Note:

Effects of eutrophication are more severe in water bodies where thermal pollution occurs because of (1) increased decomposition of organic matter and metabolism, which raises the demand for oxygen by higher organisms, (2) reduced dissolved oxygen levels in water.

Chemical pest control

Properties of an **ideal pesticide**, should;

- i) be biodegradable / non-persistent so that toxic products are not left in or on crop plants
- ii) be specific so that only pest species is killed.
- iii) not accumulate either in specific parts of an organism or as it passes along food chains.
- iv) effectively control the pest under field growing conditions.
- v) be easy to apply at the correct dosage.

<p>Problems of using insecticides</p> <ol style="list-style-type: none"> 1. Bioaccumulation (some molecules of the pesticide may be stored in specific organs or tissues at levels higher than would be expected) and biological magnification (the pesticide may get more concentrated as it passes along the food chains and webs) may occur. See the figure on the right: (Soper page 336 fig 10.32) 2. Many are non-specific, killing non-target species, particularly natural predators of the pest species i.e. by killing pests, the natural enemies of the pests will lack food hence they too will die. 	<p>Bioaccumulation</p> <p>Biomagnification</p>
---	--

3. Accidental misuse of toxic chemicals results in death of humans and domestic animal.
4. Effect on the cycling of materials
5. **Pest resistance** occurs i.e. genetic variation enables a few individuals in the pest population to survive and may quickly reproduce.
6. Effect on the cycling of materials
7. There is **pest replacement** i.e. since most crop are susceptible to attack by more than one pest species, and the pesticide may be more deadly to one species than another, elimination of one species may simply allow another species to assume major pest proportions.
8. **Pest resurgence** may occur i.e. non-specific pesticides may kill natural predators as well as pests, and so a small residual pest population may multiply quickly without being checked.

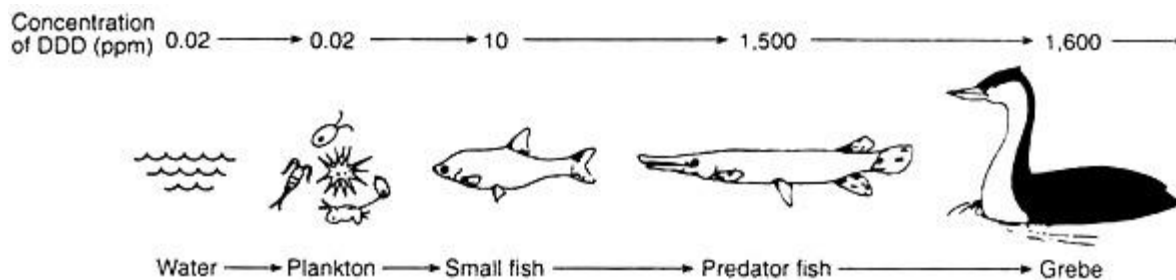
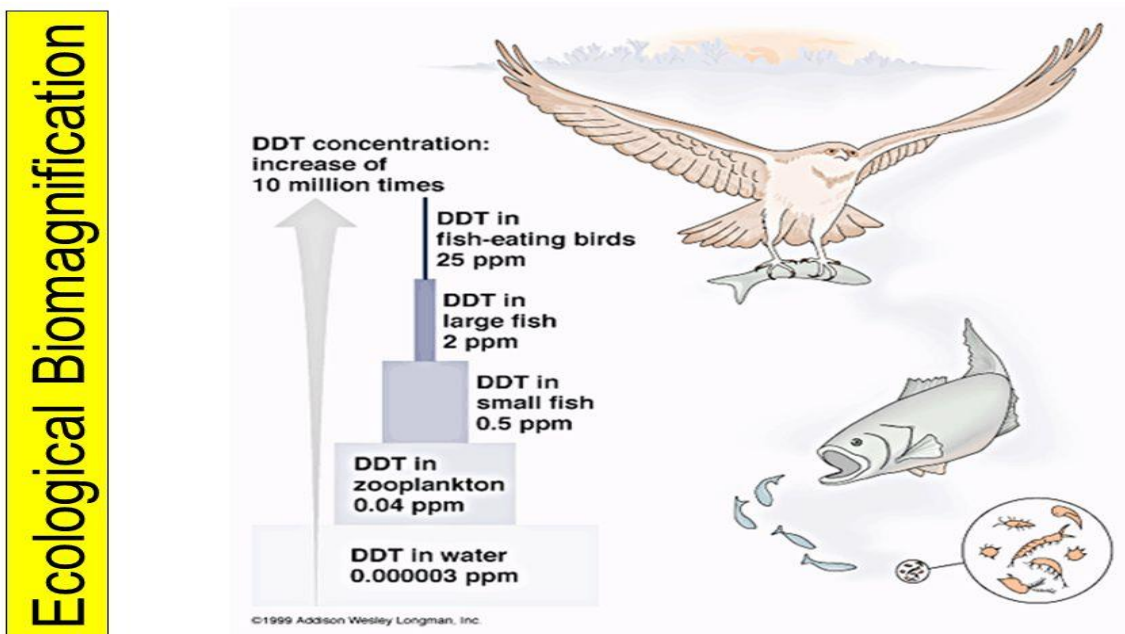

Fig. 4.12 : Biomagnification of DDD in Clear Lake, California

Dichlorodiphenyltrichloroethane (DDT)

Concentration of DDT in water = 0.000003 parts per million (ppm)

Concentration of DDT in ospreys = 75ppm

DDT concentration in osprey compared to water = $75/0.000003$

DDT therefore was magnified by magnified by a factor of 2.5 million times

Effects of DDT	Effects of other pesticides in general
i) Inhibits cytochrome oxidase enzyme. ii) Limits reproductive success, especially by causing formation of thin eggshells in birds of prey. iii) Kills organisms.	i) Inhibition of enzyme activity ii) Kill organisms. iii) Reduce species diversity iv) It increase productivity at lower levels of the ecosystem v) It increase productivity at higher levels of the ecosystem

Fig 32.18 page 540 Roberts

Biological pest control

Control of a pest population using its natural predator, parasite or pathogens

Steps involved in biological control:

- a) Identifying the pest and tracing its origins, i.e. where it came from.
- b) Investigating the original site of the pest and identifying natural predators, parasites or pathogens of the pest.
- c) Testing the potential control agent under careful quarantine to ensure its specificity.
- d) Mass culturing of the control agent.
- e) Development of the most effective distribution / release method for the control agent.
- f) Use procedures which make it impossible for the pest to complete its life cycle

Several human activities which directly destroy the environments are:

1. Deforestation; forests are important for:

Have most species and diverse wild life communities. Their destruction will lead to extinction of numerous species and less of genetic variety and potential resources.

Forests protect the soil. Deforestation leads to soil erosion, clear water supply are destroyed and silting of reservoirs.

Timber harvest, poles, food, fuel, honey, fruits and herbs

Forests catch large amounts of rain and release the water slowly into streams and rivers. Their destruction cause floods in areas down-hill.

Forests release large amounts of oxygen and absorb carbon dioxide (lock it up) during photosynthesis. Deforestation has led to increased global carbon dioxide hence causing global warming.

Forests influence the amount and frequency of rain fall received in an area.

2. Poor agricultural methods:

These include Monoculture, shifting cultivation, use of artificial fertilizers and pesticides. Excess fertilizers and pesticides leads to eutrophication of water bodies giving rise to build up of toxic by-products by leaching and draining. Pesticides/herbicides/fungicides draining away from fields enter water ways are connected through the food chain. This leads to poisoning of top carnivores.

- 3. Poor methods of mining;** such as open cast mining destroy habitats. Mineral elements mined cause destruction of the environment around the mine. Heavy metals like lead and mercury drain into water bodies causing severe destruction of aquatic fauna, poison water for human consumption; sulphides destroy vegetation altering the structure of plant and animal communities.
- 4. Urbanization/human settlement;** e.g. aggregation of people, food and water supply, garbage disposal.
- 5. Fires;** burning of fossil fuel
- 6. Cement manufacture**

NATURAL RESOURCES

From a human stand point, a resource is anything obtained from the environment to meet human needs and wants. Natural resources are those not made by man.

While some resources are directly available for use e.g. solar energy, fresh air, wind, fresh surface water, fertile soil, wild edible plants others become available after processing has been done e.g. petroleum, metallic elements like iron, ground water, modern crops.

CLASSIFICATION OF NATURAL RESOURCES

Type of resource	Example
Perpetual resources Resources that are replaced (renewed) continuously on human time scale	Solar energy, wind, tides.
Renewable resources Resources that are replenished (replaced) fairly rapidly (hours to decades) through natural processes as long as the usage is not faster than the replacement	Fresh water, fresh air, fertile soil, animals and plants (Forests, grasslands)
Nonrenewable resources Resources that exist in a fixed quantity or stock in the earth's crust. On the shorter human time scale, they depleted much faster than they are formed i.e. the energy crisis	Fossil fuels (e.g. coal, oil, natural gas), metallic minerals (e.g. copper, iron, aluminium), non-metallic minerals (e.g. salt, clay, sand, phosphates)

Further terms associated with natural resources

Sustainable yield

The highest rate at which a renewable resource can be used indefinitely without reducing its availability supply.

In spite of the renewability, renewable resources can be depleted or degraded.

Environmental degradation

The process when the resource's natural replacement rate is exceeded resulting into a decline in its availability.

Urbanization of productive land, excessive soil erosion, deforestation, ground water depletion, overgrazing of grasslands by livestock, reduction in the earth's forms of wildlife by elimination of habitats and species, pollution, water logging and salt buildup in soil.

Sustainable yield

The highest rate at which a renewable resource can be used indefinitely without reducing its availability supply.

In spite of the renewability, renewable resources can be depleted or degraded.

Reusing of resources

Using of resources over and over in the same form.

Glass bottles of alcoholic and soft drinks can be collected, washed and refilled many times.

Wildlife

This includes plants and animals that occur in their natural environment such as forests and wild animals

WHAT IS BIODIVERSITY (BIOLOGICAL DIVERSITY)?

The different life forms and life-sustaining processes that can best survive the variety of conditions currently on earth.

Kinds of biodiversity

- Genetic diversity** – variety in the genetic makeup among individuals within a species.
- Species diversity** (species richness) – number of species present in a habitat.
- Ecological diversity** – the different biological communities e.g. forests, deserts, lakes etc.
- Functional diversity** – biological and chemical processes or functions such as energy flow and matter cycling needed for the survival of species and biological communities.

Species abundance refers to the number of individuals of each species

Term	Definition/ explanation
Immigration	Movement of individuals into a population from neighbouring populations.
Emigration	Departure of individuals from a population.
Rare species	Species with small populations either restricted geographically with localized habitats or with widely scattered individuals.
Endangered species	Species with low population numbers that are in considerable danger of becoming extinct.
Extinct species	Species, which cannot be found in areas they previously inhabited nor in other likely habitats.

Factors that affect species diversity on land and in water

- Latitude** (distance from equator) **in terrestrial communities**; species diversity decrease steadily with distance from the equator toward either pole, resulting in the highest species diversity in tropical areas e.g. tropical rain forests and lowest in polar areas such as arctic tundra. The main effect of latitude is on temperature, which later affects life.
- Depth in aquatic systems**; in marine communities, species diversity increases from the surface to a depth of 2,000 metres and then begins to decline with depth until the deep-sea bottom is reached. This change is attributed to light penetration which affects photosynthesis, availability of oxygen and availability of dead organisms at the sea bottom.
- Pollution in aquatic systems**; increased pollution kills off or impairs the reproductivity of various aquatic species hence reducing species diversity and abundance.
- Increased solar radiation** increases species diversity in terrestrial communities.
- Increased precipitation** in terrestrial communities increases species diversity.
- Increased elevation** decreases species diversity.
- Pronounced seasonal changes** increase species diversity.

FACTORS THAT AFFECT SPECIES DIVERSITY IN AN ISLAND ECOSYSTEM

Robert MacArthur and Edward O Wilson (1960s) studied communities on islands after which they proposed the species equilibrium model or the theory of **island biogeography**.

- According to this model, the number of species found on an island is determined by a balance between two factors:
 - The rate at which new species immigrate to the island and**

b) The rate at which species become extinct on the island.

- The model predicts that at some point the rates of immigration and extinction will reach an equilibrium point that determines the island's average number of different species (species diversity)
- The model also predicts that immigration and extinction rates (and thus species diversity) are affected by two important features of the island;

a) Size of the island.**b) Distance of the island from the nearest main land.****Size of the island**

Larger islands tend to have higher species diversity than Small islands because of two reasons:

- Small islands generally have lower immigration rates since they are a smaller target for potential colonizers
- Smaller islands should have a higher extinction rate because they generally have fewer resources and less diverse habitats for colonizing species.

Distance of the island from the nearest main land:

For two islands of about equal size and other factors remaining constant, the island closest to the main land source of immigration species will have the higher immigration rate and thus a higher species diversity (assuming that extinction rates on both islands are about the same)

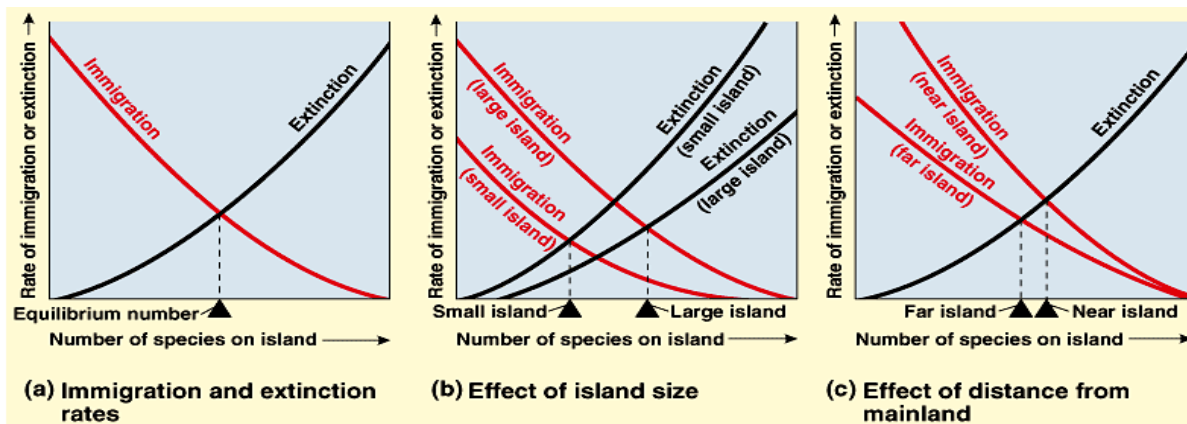
**Explanations from the observations made from the graphs****a) Immigration and extinction rates**

- The rate of immigration decreases with increase in species number, while the extinction rate increases with increase in species number on the island.
- The equilibrium number of species on the island is reached when immigration rate and extinction rate equal.
- Extinction rate increases with increasing species number because of interspecific and intraspecific competition.

b) Effect of island size on immigration and extinction rates

- The rate of extinction increases with increase in species number on the island on both small and large islands, but it is higher on small islands than on large islands. The higher extinction rate on small islands is because of the fewer resources and less diverse habitats for colonizing species.
- The rate of immigration decreases with increase in species number on both small and large islands, but with a large island having a higher immigration rate than a small island. Small islands have lower immigration rates because they are a smaller target for potential colonizers.

c) Effect of distance from mainland on immigration and extinction rates

- For both near and far islands, immigration rate decreases with increase in species number, but immigration rate is higher on near island than on the distant island. The higher immigration rate on near island is because of the easy reach by organisms enabled by its proximity to the main land.
- Since extinction rate increases with increasing species number that exert interspecific and intraspecific competition, extinction rate is far higher on small islands due to the fierce competition caused by the higher immigration rate because of easy reach by organisms enabled by its proximity to the main land.

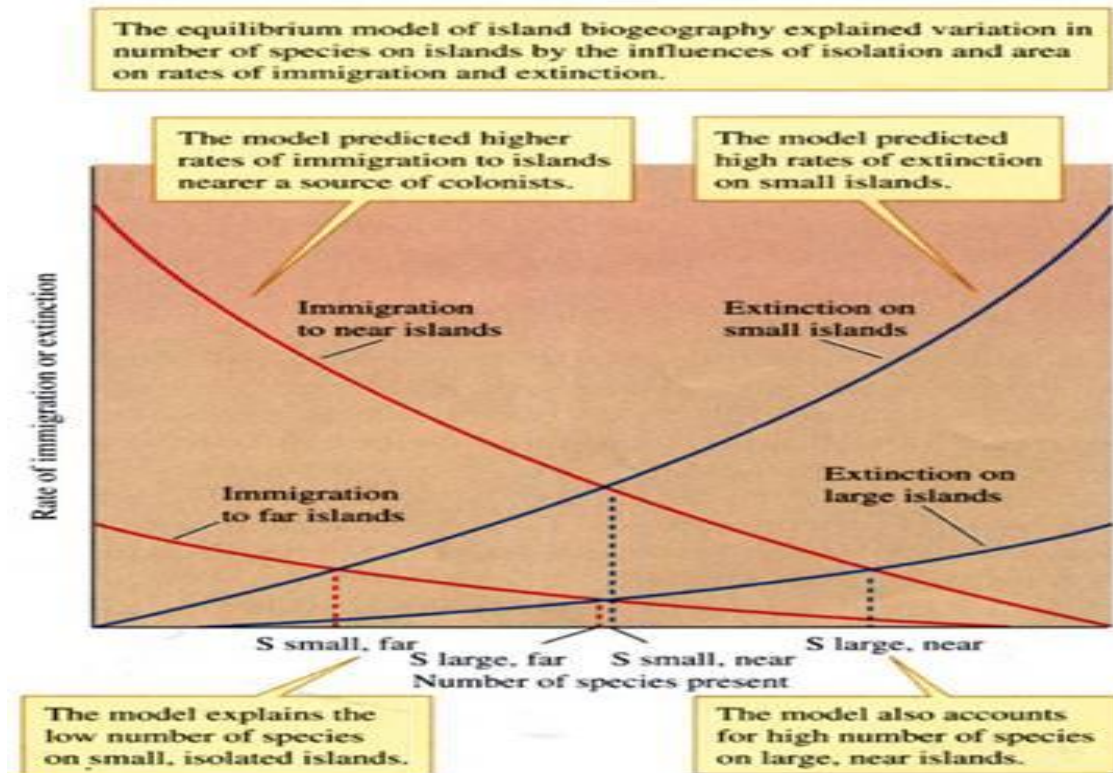

Conservation of natural resource

Ecosystems contain natural biological resources which are useful for (1) food (2) medicine (3) raw materials for industries (4) biological control of pests and diseases (5) biogeochemical cycling (6) pleasure i.e. ecotourism.

Some of the conservation methods employed include;

(a) restricting urban and industrial development	(f) establishing conservation areas such as national parks, zoos, botanical gardens, nature reserves and sanctuaries
(b) implementing recycling programmes	(g) effective pollution control methods, especially when wildlife species are vulnerable to pollutants
(c) legislating the protection of endangered and keystone species, and enforcement of the law	(h) creating corridors that connect habitat fragments
(d) carrying out breeding programmes and establishing sperm/seed banks to maintain high biodiversity	(i) bioremediation i.e. using organisms e.g. fungi and prokaryotes to detoxify polluted ecosystems
(e) implementing sustainable development programmes	

SAMPLE QUESTIONS

1. The graph in figure1 table shows the rate of decomposition of the same plant material with depth below the soil surface in forest habitat. Study the figure and table and answer the questions that follow.

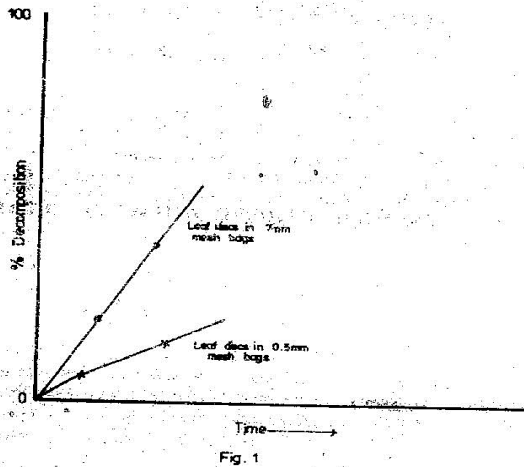

Depth (cm)		1	2	3	4	5	6	7	8	9	10
%decomposition	7mm	95	80	65	50	35	20	8	2	0	0
	0.5mm	40	35	20	10	6	3	1	0	0	0

- Using the same axes plot graphs of percentage decomposition against soil depth.
- Explain the relationship between
 - The mesh size
 - Soil depth and rate of decomposition of the leaf discs.
- Copy out figure 1 and extrapolate both graphs in the figure to Show the trend of decomposition of the leaf discs with time.
- What is the ecological significance of leaf decomposition in a natural habitat?

2. Analysis of oxygen dissolved and PH in the upper layer of water together with productivity of the entire water body was carried out in one of Uganda’s most productive lakes. The results of this analysis are shown in the table below. Study the tables and answer the questions that follow.

Table 1: OXYGEN DISSOLVED AND PH.

	Night			Day			Night		
Time/hrs	24:00	3:00	6:00	9:00	12:00	15:00	18:00	21:00	24:00
%saturation of oxygen	65	55	35	65	85	115	105	85	75
PH	6.6	6.5	6.4	6.6	6.8	6.8	7.0	6.8	6.7

TABLE 2: PRODUCTIVITY.

Time Depth/m	Still air			Windy air		
	Day	Dark	Net productivity/ gm ⁻³	Day	Dark	Net productivity/ gm ⁻³
Limnetic 100	3.30	1.30	2.00	2.70	0.30	2.40
Littoral 300	7.50	1.50	6.00	7.80	2.00	6.80
Profundal 500	4.70	0.40	4.30	5.30	600	4.70
Benthic 700	0.30	0.10	0.20	0.40	0.20	0.20

- Plot a graph of net productivity in the different zones/layers of the lake under still and windy conditions.
- Describe and explain the pattern of variation of productivity in still and windy conditions in the different layers of the lake.

- (c) Explain the pattern of oxygen content dissolved and PH in the upper layer of the lake for a period of 24 hours.
- (d) Explain what would happen to the above three factors in the water body if organic fertilizers were added to the system after a long period of time.
- (e) Apart from the factors mentioned above, state any other factors that would determine the percentage saturation of oxygen in a lake.

3. Figures 1, 2 and 3 show the immigration and extinction of species on different categories of virgin islands.

Figure 1 shows the rate of immigration of new species on an island nearby the shore and one that is far from the shore.

Figure 2 shows the rate of extinction of species on a large island and on a small island.

Figure 3 shows the rate of immigration and extinction of species on an island.

Study the information and use it to answer the questions that follow.

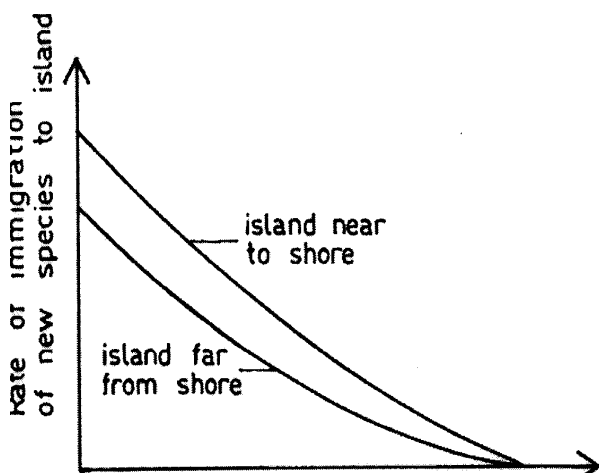

Fig. 1 Number of species

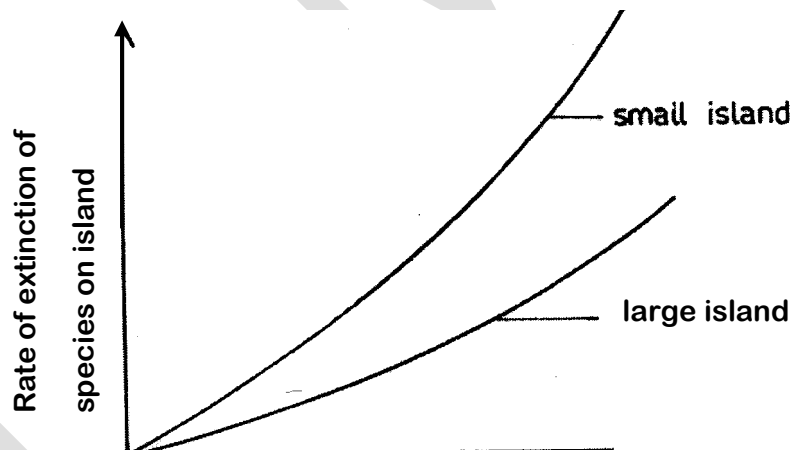

Fig. 2 Number of species

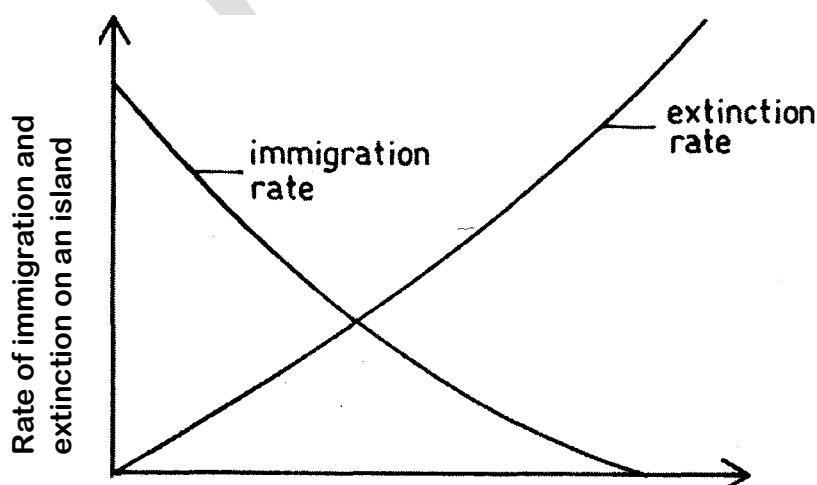
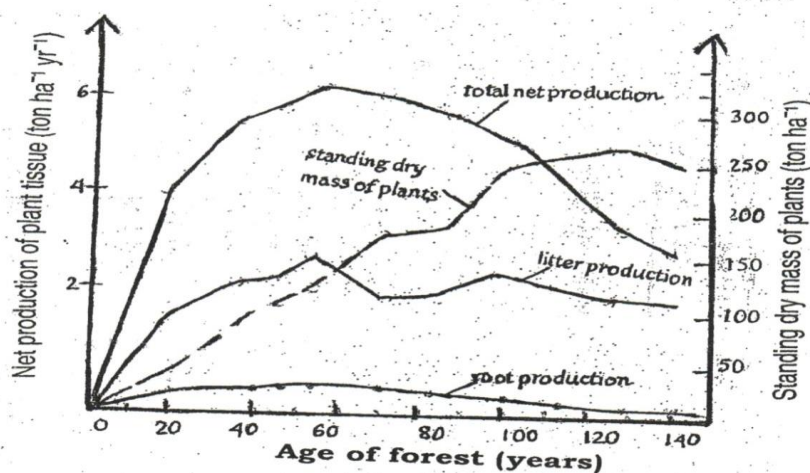

Fig. 3 Number of species

(a) Explain the rate of

- (i) immigration of new species on an island that is near to the shore and one that is far from the shore (figure 1). (10 marks)
- (ii) extinction of species on a small island and on a large island (figure 2) (09 marks)
- (iii) immigration and extinction of species on an island. (figure 3) (07 marks)
- (b) From figures 1, 2 and 3 what conclusions can you draw about what determines the number of species on an island? (05 marks)
- (c) Describe how factors other than those depicted in the information provided, may affect the immigration of new species on an island. (04 marks)
- (d) Suggest the factors that would cause immigration of new species to a virgin island. (05 marks)
4. (a) Give the characteristics of predator-prey interactions in nature (05 marks)
- (b) In what ways do the predator-prey interactions compare with parasite-host interactions (07 marks)
- (c) Explain how predator-prey interactions influence the formation of a new species (08 marks)
5. Discuss the effects the following might have if
- a) Untreated sewage entered a slow flowing river (07 marks)
- b) Hot water from a cooling tower of a power station entered a slow flowing river (06 marks)
- c) A forest is cleared to establish an industrial park (07 marks)
6. (a) Discuss the various forms of population dispersion in ecosystems
- (b) Explain the various phases of the following population growth curves in ecosystems
- Sigmoid curve
 - Boom and burst curve
 - T-shaped curve
- (c) (i) Sketch a curve to illustrate population changes in island biogeography
- (ii) Explain the rate of extinction and immigration curves in a bigger and small island shown in your sketch
- (e) Discuss the various methods of estimating population sizes of small animals and plant, stating the advantages and disadvantages of each method
7. (a) (i) How might thermal pollution cause the death of fish such as tilapia? (02 marks)
- (ii) Explain why the addition of nitrogen fertiliser to sea water can accelerate the cleanup of an oil spill (02)
- (b) For each of the following agricultural practices, state two benefits and two adverse environmental or human consequences. (16 marks)
- Deforestation
 - Applying nitrogenous fertiliser to crops
 - Growing crop plants with genetically engineered plants which are resistant to herbicides
 - Burning agricultural waste such as coffee husks
8. The graph below shows the changes in total net production, standing dry mass of a plant litter and root production in a freshly planted forest over the years



- (a) Compare the total net production with litter production of plants (06 marks)
 - (b) Describe the changes in the four variables shown in the graph (15 marks)
 - (c) Account for the changes described in (b) above (12 marks)
 - (d) Predict the likely changes in each variable if the study is repeated and the climate remains constant
9. (a) What is meant by endangered species? (02 marks)
- (b) Describe how organisms become endangered (08 marks)
- (c) How would you ensure that organisms that are endangered get conserved (08 marks)
- (d) Suggest reasons why large mammals are more prone to extinction than small mammals. (02 marks)
10. (a) What is an ecosystem?
- (b) Describe the flow of energy and recycling of carbon and nitrogen in any named ecosystem
11. (a) How are the following organisms adapted to their modes of life
- (i) *Schistosoma mansoni* (iv) Puccinia
 - (ii) *Ancylostoma duodenale* (v) Tick
 - (iii) *Ascaris Lumbricoides* (vi) Phytophthora infestans
- (b) Give a brief description of the major types of interspecific associations in nature
- (c) Outline the life cycle of:
- (i) Plasmodium (iii) Schistosoma
 - (ii) Tapeworm (iv) Filarial worm
- (d) Rhizobia lives a symbiotic life with legume plants
- (i) What is meant by symbiotic life
 - (ii) What are the benefits of the symbiotic associations between rhizobia and the legume
12. The data below shows the number of larvae in the sprayed and unsprayed areas with varying concentration of DDT for given months of application. **Table 1** shows the changes after three applications of DDT in June, July and August. **Table 2** shows changes after one application of DDT in August.

Table 1

Months		June				July				August		
Concentration of DDT (ppm)		3	5	7	9	11	13	15	17	19	21	23
Number of larvae	Sprayed	2	4	6	10	16	34	72	104	114	118	120
	Unsprayed	6	6	6	8	10	16	30	46	56	60	60

Table 2

Month		August							
Concentration of DDT (ppm)		20.0	20.8	22.2	23.4	24.6	26.0	28.0	30.0
Number of larvae	Sprayed	0	2	10	30	60	92	106	112
	Unsprayed	0	6	18	18	78	92	98	100

- (a) Using graph papers draw graphs for;
 - i. One application of DDT in August
 - ii. Three applications of DDT in June, July and August
 - (b) Using bar graphs and the graphs you have drawn in (a) (i) and (ii), describe the changes in the number of larvae for sprayed and unsprayed after
 - i. One application of DDT in August
 - ii. Three applications of DDT in June, July and August
 - (c) (i) Explain the terms non-targets and pesticide resurgence
 - (ii) Using your knowledge of pesticides, explain the results obtained in the experiments for both one application and three applications of DDT in the sprayed and unsprayed areas
 - (d) (i) Why is DDT considered to be a potentially bad pesticide?
 - (ii) What are the quantities of a good parasite?
13. In shallow water bodies, e.g. ponds and lakes, the water temperature varies with depth. In deep waters of lakes in temperate regions, a thermocline forms during summer. A thermocline is a middle layer in a lake where temperature changes rapidly with depth.

The table below shows the seasonal changes in temperature and oxygen content with depth

Depth/m	Temperature/°C		Oxygen concentration/ppm	
	Winter	Summer	Winter	Summer
0	0	25	12	15.0
1	2.5	24.5	12	15.0
2	3.5	23.3	12	15.0

3	4.0	23.0	12	14.5
5	4.0	22.0	12	13.0
7	4.0	15.0	12	9.0
9	4.0	15.0	12	3.5
11	4.0	8.0	11.5	3.5
13	4.0	5.0	11.5	0.0
15	4.0	5.0	11.5	0.0

- a. Represent the data in a graph form on the same axis
- b. From your graph, determine the depth range at which the thermocline forms in summer
- c. (i) In summer, organic matter tends to collect, i.e. accumulate at the lake bottom. Explain the role of the thermocline in this phenomenon
- (ii) Where and when the thermocline persists, the warm layers can support a very limited biomass
- 14. (a) What is meant by the term ecological succession?
- (b) Describe the stage involved in succession on an abandoned farm land?
- (c) How does biomass, specie number and biodiversity vary with the several stages of succession?
- (d)
- 15. (a) What is meant by;
 - (i) Greenhouse effect (02 marks)
 - (ii) Eutrophication (02 marks)
- (b) To what extent have human activities contributed to the enhanced greenhouse effect? (10 marks)
- (c) Suggest practical remedies to the greenhouse problem (06 marks)
- 16. Antelopes are common in E. Africa grasslands. Outline the inter-relationship which may exist between the antelopes and;
 - a) Other mammals
 - b) Insects
 - c) Green plants
- 17. The table below shows the characteristics of pastures under varying grazing intensities in Rwenzori National Park in Uganda.

QUALITY OF PASTURE	GRAZING INTENSITIES		
	Under grazed	Moderate over grazing	Heavily overgrazed
Number of sample surface quality (% of sample)	158	60	110
With vegetation	24.1	31.1	17.6
Bare but protected (with shade)	72.1	15.7	17.0
Completely bare with soil erosion	3.8	52.6	65.4
Composition of vegetation occurrence	0.0	6.1	50.8
Palatable grasses	71.3	36.3	0.4
Unpalatable grasses	5.3	34.5	28.9
Shrubs	0.0	4.7	33.1

Study the table above and answer the questions below;

- (a) (i) Describe quality of the surface in Rwenzori National Park
 - (ii) Account for the quality of the surface from the composition of the vegetation
- The figure below illustrates the pattern of changes of flora and mammals faced with increasing levels of overstocking in a game reserve

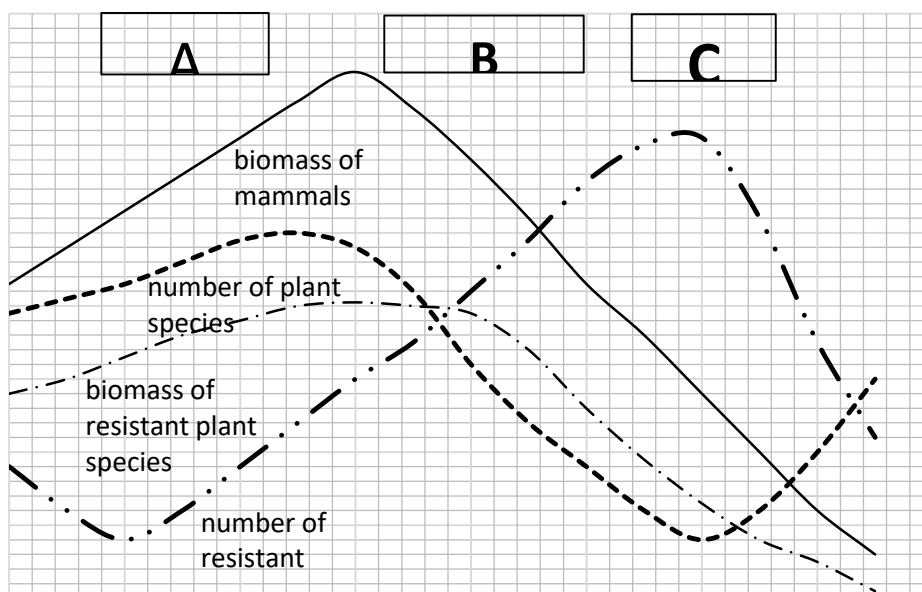

- (b) (i) State the level of overstocking in A, B and C.
- (ii) Explain the relationship between the number of plant species, number of species of mammals and biomass of resistant plant species
- (iii) State five criteria that can reflect the presence of over grazing
- (c) What factors should be taken into account for proper management of range in a game park?

- 18. (a) What is meant by the term parasite?
- (b) With examples, describe the adaptations of parasites to their mode of nutrition
- 19. In nature, organisms of the same kind rarely occupy the same niches at the same intervals, studies carried out around Natete Market showed four species of fresh eating birds occupying the same niches. These birds were found when either packing feathers, resting, soaring or feeding. The feeding patterns of all species of birds were recorded over time on a daily basis and the average of the numbers feeding in each species was computed for a period of one month. The results are shown in the table below;

	Time	7am	8am	9am	10am	11am	12pm	1pm	2pm	3pm	4pm
Bird species	Marabou stock	5	6	8	10	9	8	6	5	3	2
	Kites	10	11	13	20	15	10	13	12	10	10
	Bald headed eagle	25	27	24	16	11	5	5	18	19	20
	White breasted eagle	3	10	18	26	37	47	38	30	21	26

The sizes of these birds from the smallest are arranged as in the table above;

- (a) Plot a graph of the diurnal feeding patterns of these birds on the same axes
- (b) (i) Describe the nature of the graphs
- (ii) Suggest explanations for the patterns described in (b) (i) above
- (iii) Identify the curve which behaves abnormally and account for the strange behaviour of the bird it represents
- (c) (i) From your graph, suggest how organisms of the same kind can occupy the same niche
- (ii) What would happen to the organisms if they do not adopt to the mechanisms in (c) (i) above
- (d) (i) What is the importance of vultures in nature?
- (ii) What would happen to the habitat if all the vultures were poisoned?
- (e) (i) Outline the method which was used to obtain the data above
- (ii) Suggest two advantages of the method given in (e) (i) above and give reasons for your answer
- (e) How does the relationship in (d) compare with that in (a)
- 20. A study was carried out on the effect of fire on a savannah grassland. The figure below shows temperature recorded during a period of 5 minutes while a front of fire passed through a stand of dry grasses.

figure 1

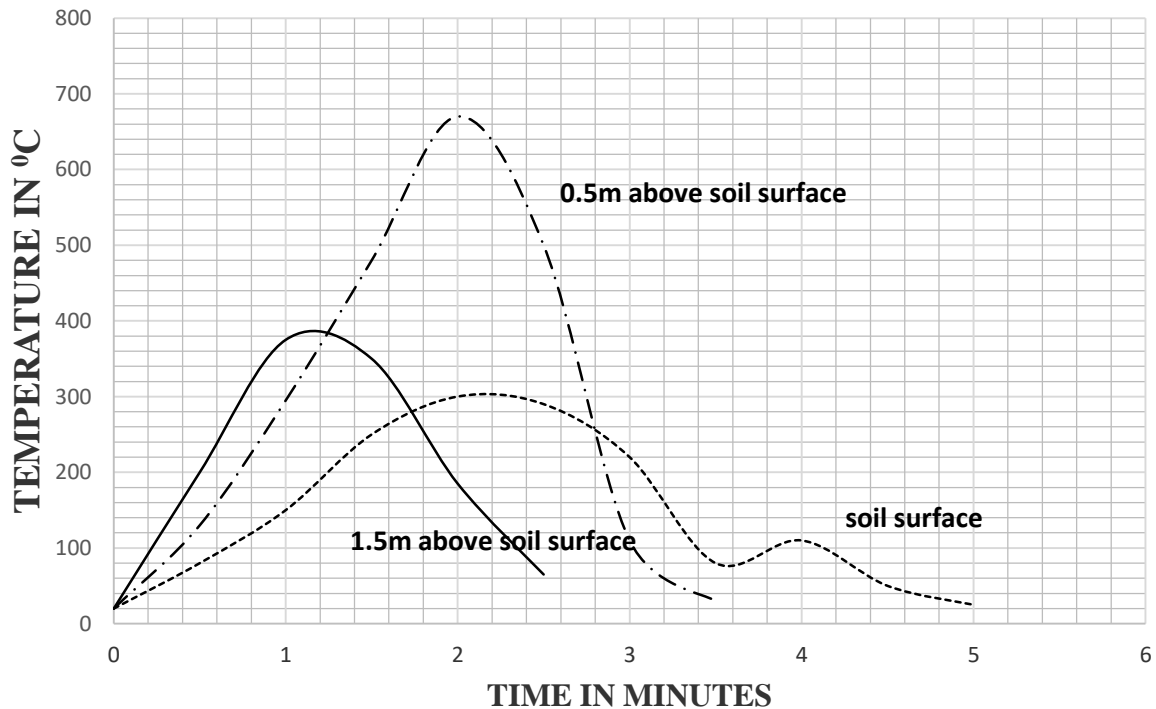

Table 1 below shows the effect of grass fire upon biomass and numbers of arthropods per 100cm³ in grassland plots studied.

	Eve of fire	One day after fire	% reductions	One month after fire
Biomass Nos.	60.1	19.5	67.6	19.8
Grasshoppers	135	9	93.3	200
Caterpillars	83	23	72.3	30
Mantids	84	39	53.6	36
Aphids e.t.c.	331	11	96.7	17
Large Hemiptera	201	53	73.6	64
Cockroaches	104	86	17.3	29
Arachnids mostly spiders	1341	1273	5.1	533
Total	2688	1710	36.1	1044

Study figure 1 and table 1 carefully and then answer the questions that follow;

- (a) (i) Comment on the temperature changes recorded during the study
 - (ii) What would have most likely
 - (b) (i) What was the effect of the grass fire on the arthropods?
 - (ii) Explain the recovery from the effect of such fire upon other fauna?
 - (c) Explain the recovery from the effects of fire in the grassland
 - (d) In what other ways is fire important in a grassland?
 - (e) Outline the ways in which a grassland community may be modified?
 - (f) Which arthropods are most affected by fire
 - i. Immediately after the fire
 - ii. One month later
 - (g) How would you explain each of these observations?
 - (h) Why is grassfire less likely to destroy birds and small animals?
21. (a) Explain the causes and effects of destruction of the stratosphere marks) (07)
- (b) Compare oligotrophic and eutrophic lakes (10 marks)
- (c) By giving an example, explain the term indicator species (03 marks)
22. (a) (i) How might thermal pollution cause the death of fish such as tilapia? (02 marks)

- (ii) Explain why the addition of nitrogen fertiliser to sea water can accelerate the cleanup of an oil spill
- (b) For each of the following agricultural practices, state two benefits and two adverse environmental or human consequences. (16 marks)
 - v. Deforestation
 - vi. Applying nitrogenous fertiliser to crops
 - vii. Growing crop plants with genetically engineered plants which are resistant to herbicides
 - viii. Burning agricultural waste such as coffee husks

- 23. (a) Distinguish between primary and secondary succession
- (b) Describe the process of primary succession on bare rock
- (c) Describe how energy flows in an ecosystem

- 24. How are the following plants adapted for their habitats
 - a. Xerophytes
 - b. Hydrophytes
 - c. Halophytes
 - d. Mesophytes

- 25. Discuss the various methods of estimating population sizes of small animals and plant, stating the advantages and disadvantages of each method

- 26. In an ecological study of an aquatic habitat, a researcher carried out experiments on a small stagnant water body which had been left behind a swamp during a long drought. He observed a surface which contained some decomposing leaves and grass. After carrying out his experiments, the results on the saturation of oxygen and pH of water at the various depth of the water body were put in a table as shown below.

Depth below water surface (cm)	00	05	10	20	40	60	80	100	In mud
Oxygen saturation by percentage	86	90	80	40	10	08	04	02	00
pH	8.0	7.6	7.0	6.0	5.8	4.5	3.0	2.7	2.0

- (a) Represent the above information on a graph paper
 - (b) From the graphs above, explain your observations about variation of
 - i. Oxygen saturation and depth
 - ii. pH and depth
 - iii. pH and oxygen saturation
 - (c) Give an account of the effect of pH and oxygen concentration on aquatic organisms
 - (d) How the aquatic organisms in (c) above are adapted to their environment
 - (e) Briefly describe an experiment on how the researcher obtained the pH at various depths
- 27. The graph below shows the changes in total net production, standing dry mass of a plant litter and root production in a freshly planted forest over the years

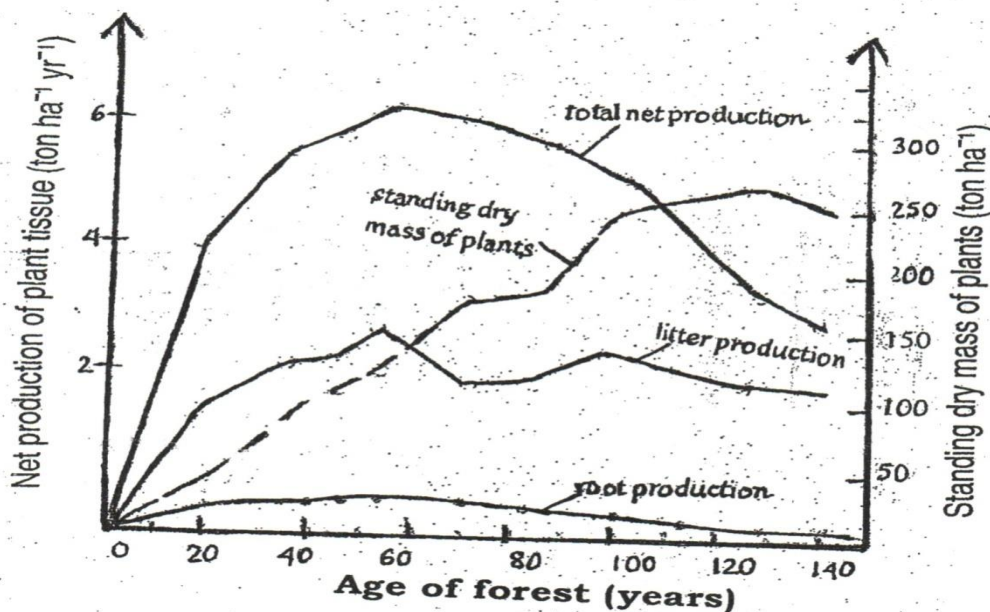

- (a) Compare the total net production with litter production of plants (06 marks)
- (b) Describe the changes in the four variables shown in the graph (15 marks)
- (c) Account for the changes described in (b) above (12 marks)
- (d) Predict the likely changes in each variable if the study is repeated and the climate remains constant (05 marks)
- (e) What factors can deflect the changes occurring in the forest (05 marks)

Figure 2 shows the change net primary productivity and biomass above the ground in a forest following an ecological fire.

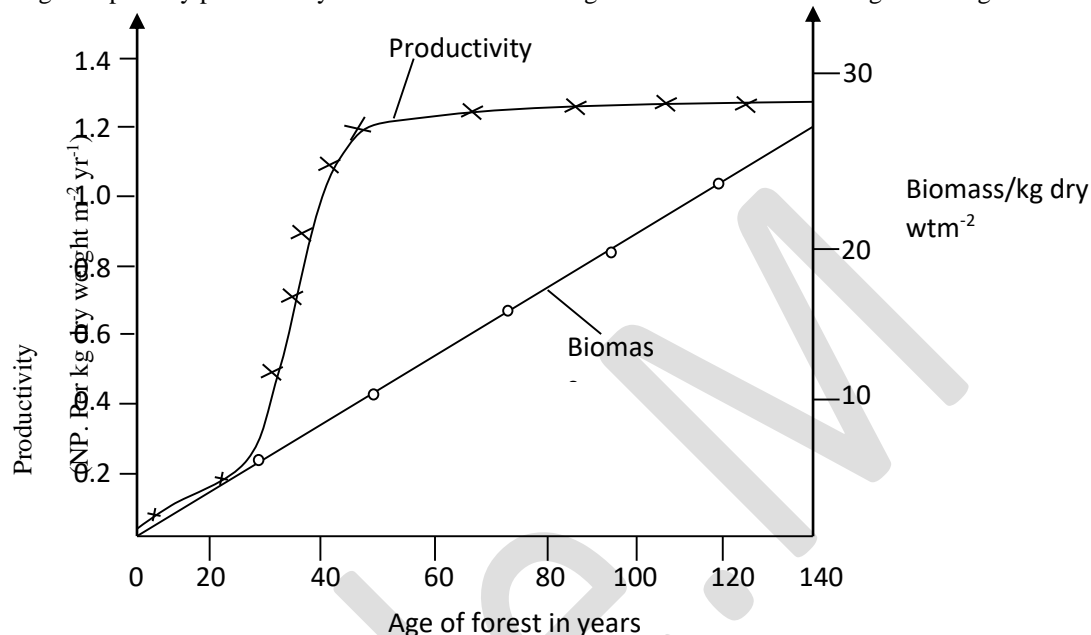

- (i) Describe the changes in each of the variables shown on figure 2. (05 marks)
- (ii) Account for the changes described in b (i) above. (07 marks)
- (iii) Sketch a curve on **figure 2** to show the productivity; biomass ratio would change with time.
 - (iv) Suggest an explanation for the curve drawn in (iii) above. (05 marks)

28. (a) Outline the major adaptations of plants to survive;
- i. In fresh water
 - ii. On dry land
- (b) How do these adaptations compare with those of animals in similar habitats?

29. *Echnococcus granulosis* is a tapeworm commonly found in domestic animals, and man gets infected when he eats meat containing viable larval stages of the parasite. An investigation was carried out to determine the incidence of the parasite at a Kampala City abattoir. Table 1 shows the results of the investigation. Study the table carefully and then answer the questions that follow

Month		Jan	Feb	Mar	Apr	May	Jun	Jul	Aug	Sep	Oct
Cows	Total slaughtered	1099	1014	947	1201	940	1070	1050	768	1253	1091
	No. of infected livers	10	1	8	0	4	7	8	8	8	5
	No. of infected lungs	18	18	45	71	59	74	112	65	81	55
	% infection	2.7	1.8	5.6	5.9	6.7	7.6	11.4	9.5	7.1	5.5
Goats	Total slaughtered	1074	1481	1055	1053	60	1239	1209	1150	851	649
	No. of infected livers	5	3	4	0	0	5	12	5	3	2
	No. of infected lungs	15	8	39	0	29	42	89	41	37	22
	% infection	1.9	0.7	4.1	0.0	4.8	3.8	8.4	4.0	4.7	3.7

- (a) What conclusions can you draw from the results in the table?
- (b) (i) Plot histograms of percentage infection against time of infection for goats and cows
 - (ii) What do you observe concerning the patterns of infections of goats and cattle?
 - (iii) What explanation can you suggest for these patterns?
- (c) Suggest three ways by which the risk of infection to man could be reduced
- (d) Describe how you would conduct an experiment to determine the incidence of *E granulosis* in goat populations in a district in Uganda

30. Describe how you would conduct experiments to determine changes in population of the following organisms:
- A species of plant in a grassland
 - A small mammal such as a rodent also in a grassland area
 - Protozoa in a water pond
31. (a) Outline the effects of large mammals in a national park
- Using a suitable method, describe how their population size may be determined
 - Explain the management of such mammals for a suitable ecosystem
 - What are the values of National Parks to Uganda
 - What problems are often encountered in the management of National Parks?
32. (a) Insects are known to be the most successful animals in colonising a wide area on land. Discuss the adaptations which have made them successful.
- Some insect species are known to be very serious pests and vectors of disease to man and his crops. Outline the various ways available to control them and their effects.
 - Describe the systematic operation of an insect's heart
33. (a) Plants occupy the most important niches in an ecosystem.
- Explain the above statement
 - How do plants avail energy to the next trophic level
 -
- Explain why trophic levels do exceed six
 - Describe the process of primary succession leading to the climax community
 - Discuss man's activities that have led to the formation of endangered species

34. (a) Explain the effect of predation on population size of organisms
- How has man affected the balance between predator and prey in a negative way?
 - Giving examples, explain the various ways in which variation may arise
35. An investigation into the composition and number of arthropods found in forest and shrub savannah habitats was carried out. The table below gives the profile of the results. Study the table and answer the questions that follow;

Type of arthropod	Forest habitat	Savannah habitat
Arachnids other than mites	25	10
Mites	180	25
Winged insects other than mosquitoes	140	39
Mosquitoes	30	10
Larvae of winged insects	81	12
Millipedes	82	10
Centipedes	11	11
Wood lice	52	10
Beetles	30	130

- Using the same axes, represent the information on a graph paper
 - Comment briefly, on the relative abundance of the arthropods in both the forest and savannah habitats
 - Account for the habitat preference shown by
 - Beetles
 - Millipedes
 - (i) Suggest two suitable methods which could possibly have been used to determine the number of winged insects in the forest habitat and describe in detail the procedure used for both of them
 - State the advantage of the methods used in (d) (i) above
36. (a) (i) Explain the effect of predation on population size of organisms (05 marks)
- How has man affected the balance between predator and prey in a negative way (05 marks)
- (b) (i) How can the population of tilapia fish in a pond be determined by the Lincoln index (Capture-mark-recapture) method? (07 marks)
- State the assumptions made in (b) (i) above (03 marks)
37. (a) Give the characteristics of predator-prey interactions in nature (05 marks)
- In what ways do the predator-prey interactions compare with parasite-host interactions (07 marks)
 - Explain how predator-prey interactions influence the formation of a new species (08 marks)

38. Discuss the effects the following might have if
- d) Untreated sewage entered a slow flowing river (07 marks)
 - e) Hot water from a cooling tower of a power station entered a slow flowing river (06 marks)
 - f) A forest is cleared to establish an industrial park (07 marks)
39. (a) Discuss the various forms of population dispersion in ecosystems
 (b) Explain the various phases of the following population growth curves in ecosystems
- i. Sigmoid curve
 - ii. Boom and burst curve
- (c) (i) Sketch a curve to illustrate population changes in island biogeography
 (ii) Explain the rate of extinction and immigration curves in a bigger and small island shown in your sketch
40. A factory emitting smog containing sulphur dioxide and carbon dioxide was cited in a rural district. The table below gives distance and directions of :
- iii. Number of moths and
 - iv. Concentration of sulphur dioxide in smog in different directions from the factory chimney

Table 1

Distance from factory in a south-south West direction (miles)	1	2	4	8	12	16	28
Number of moths species	0	1	2	3	7	9	12
Sulphur dioxide concentration/parts per million	28	27	26	23	19.5	16	2

Table 2

Distance from factory in a north north east direction (miles)	1	2	4	8	12	16	28
Number of moths species	1	2	3	4	4	5	5
Sulphur dioxide concentration/parts per million	27	26.5	25	24	23	22	19

- f) Plot the information to show the relationship between the moth species distribution and the sulphur dioxide concentration the same X-axis and Y-axis. (12 marks)
 - g) Explain the difference in results between obtained for the south-south west direction and those obtained for the north-north east direction (02 marks)
 - h) Fully explain why the number of moths increase with increasing distance from the factory (04 marks)
 - i) The results obtained give evidence of present day evolution. Explain fully this evidence and its significance in evolution (10 marks)
 - j) What are the environment effects of sulphur dioxide and carbon dioxide? (08 marks)
41. The figure below shows some of the effects of sewage and waste copper discharge into a river.

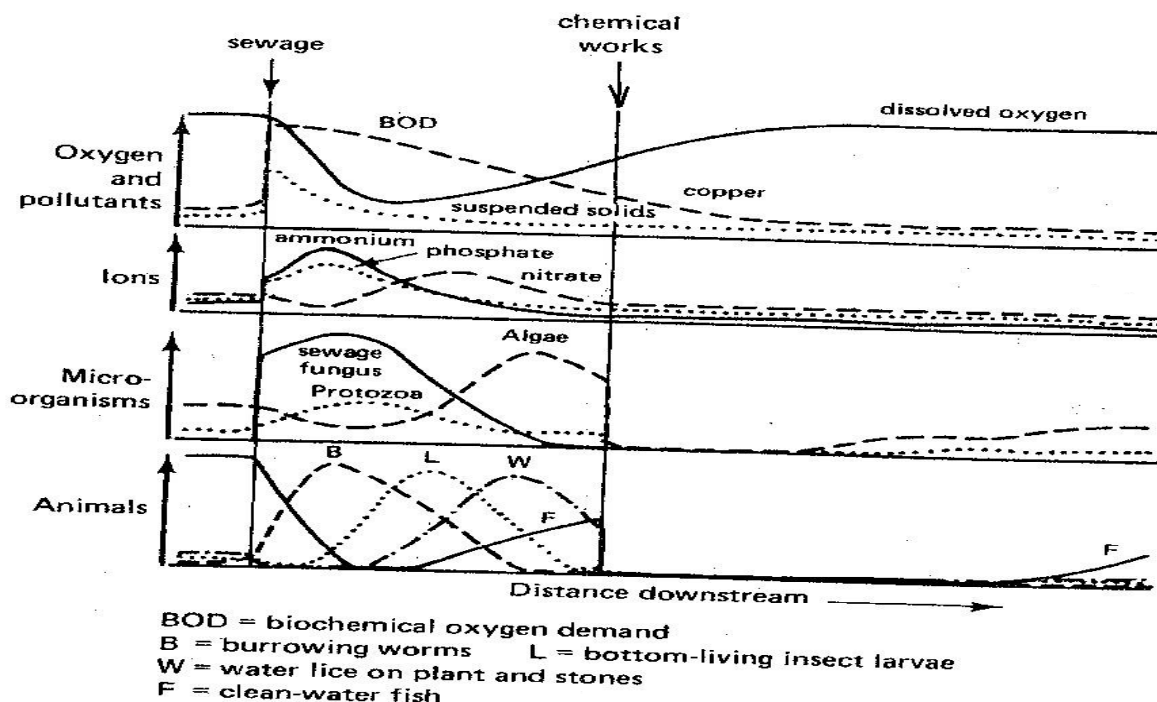

- (a) What is meant by the term **biochemical oxygen demand** (BOD)?
 - (b) Account for the changes in:
 - (i) BOD.
 - (ii) ion concentration
 - (iii) Population of micro-organisms
 - (iv) Population of fresh water fish
 - (c) Compare the populations of sewage fungus and algae.
 - (d) (i) Using evidence from the diagram, suggest the method by which an organism might be used as a pollution indicator
 - (ii) Suppose that the chemical works also discharged thermal pollution, suggest one possible effect on the river's chemical content and one possible effect on its biological content.
42. (a) State the advantage of complete metamorphosis over incomplete metamorphosis (03 marks)
- (b) Account for the physiological changes that occur during pregnancy up to lactation (10 marks)
- (c) Explain the effect of photoperiod on metamorphosis in a named arthropod or amphibian (07 marks)
43. (a) What do you understand by the term global warming?
- (b) To what extent global warming affected your country? Discuss with the aid of examples from your country and the globe at large.
- (c) Give ecological impacts of global warming on ecosystems
- (d) How can the nations work to alleviate the impact of global warming?
- (e) Discuss the impacts of non-degradable pollutants like polythene papers on living organisms
- (f) Describe with specific examples how different animals conceal themselves from their enemies
44. In an experiment to study the effect of DDT towards the cabbage pest, *Pieris rapae* which feeds on cabbage leaves, two adjacent farm yards were prepared. *Pieris* was introduced in each of them and left for some time. After spraying one farm with DDT for three consecutive times, the number of eggs that survived and hatched into larvae at the sprayed and non-sprayed farm yards were determined as shown in **graph A**
- In another experiment, *Pierisrapae* was exposed to birds as its control agents and the changes in the population of both, with time, was determined as indicated by **graph B**

GRAPH A

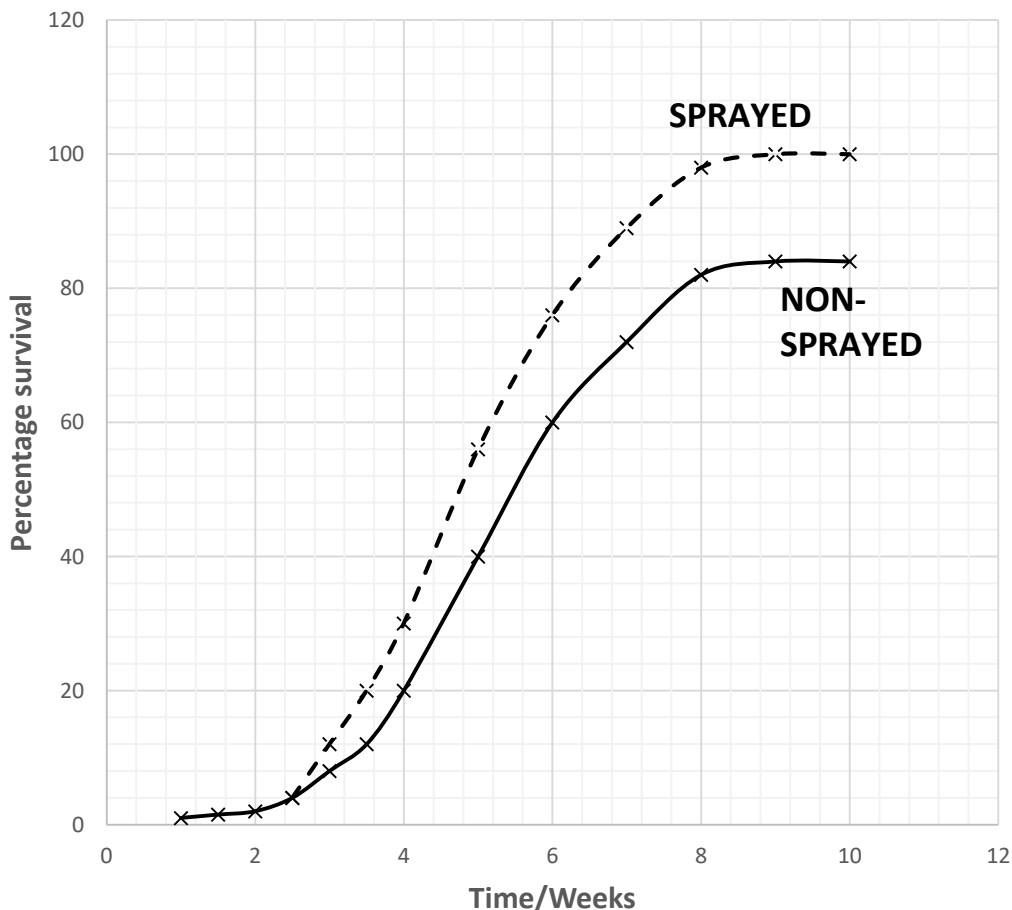

GRAPH B

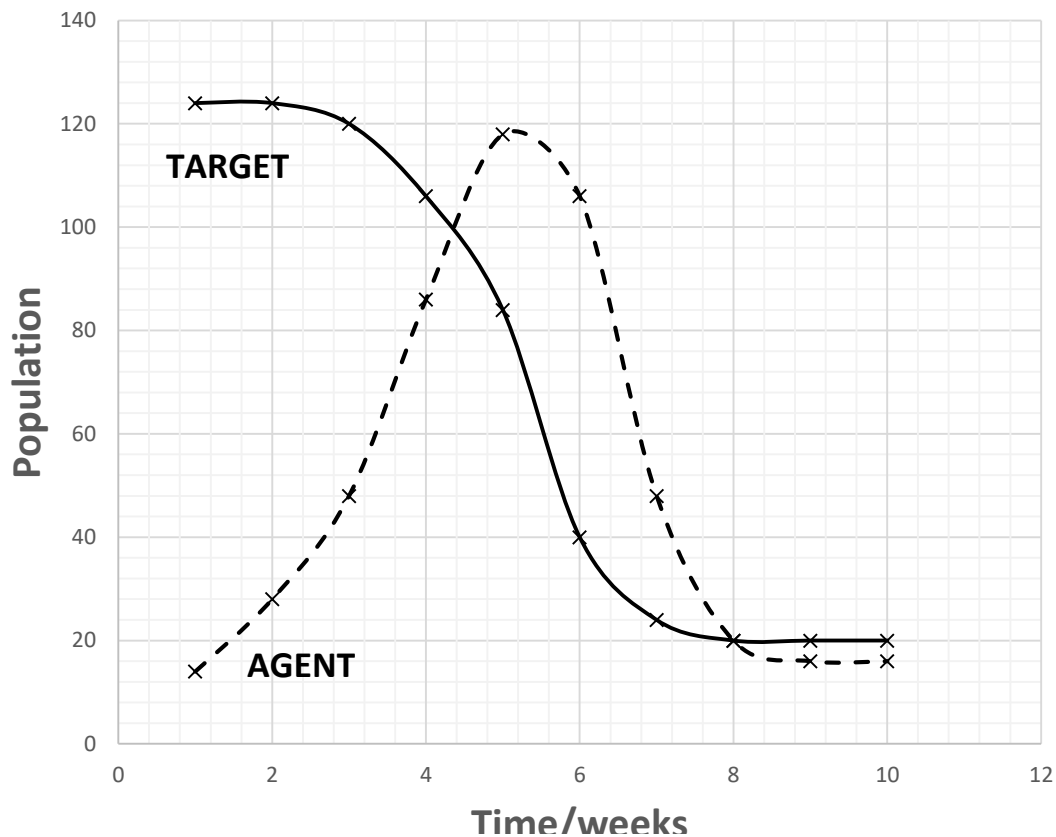

- a) (i) Compare the number of eggs of *Pieris* between the sprayed and non-sprayed farm yards (04 marks)
(ii) Account for the differences in the number of eggs of *Pieris* at the sprayed and non-sprayed farm yards (08)
(iii) Explain any one property of DDT other than the one shown above, which renders it unsuitable for environmental use (08)
- b) (i) Compare the populations of the target organism and the control agent (06 marks)
(ii) What term is normally given to such controls?
(iii) Describe the changes in the population of the control agent (05 marks)
(iv) Explain the changes in the population of the control agent and the target organism (10 marks)
(v) From the graph, what seems to be the ultimate aim of this type of controls?
(vi) What would happen if the control agent completely eradicates the prey?
(vii) What should be taken into account in selecting such as a controlling agent?
- c) Outline any three advantages of the method in Graph B to that in Graph A

45. (a) What is meant by the term **ecosystem**?
(b) Describe the flow of energy and cycling of carbon and nitrogen in any named ecosystem
(c) Suggest reasons why felling and removal of forest trees result in changes in the levels of nutrients in the soil
(d) In an investigation of a fresh water pond, 35 water bugs (*Notonecta*) were caught, marked and released. Three days later 35 water bugs were caught and 7 were found to be marked.
- What is the approximate size of population of water bugs in the pond? Show your working.
 - Give three reasons why capture-recapture is unlikely to be an accurate way of assessing the size of a water bug population

46. The figure shows the amount of DDT at different levels on a food chain. The figure below represents the amount of DDT in parts per million (ppm)

Concentration of DDT/ppm	Trophic level	Example
75	Carnivore 2	Osprey
50	Carnivore 1	Large fish
10	Herbivore	Small fish
0.04	Producer	Algae

- a) Calculate the concentration factor of DDT in passing from into;
 - i. The primary producer
 - ii. The carnivore 1
 - iii. The herbivore

If the concentration of DDT in the water was 0.02ppm (show your working)

- b) What conclusions can be drawn from the answers in (a) above?
- c) At which trophic level;
 - i. Is DDT likely to have the most marked effect?
 - ii. Would DDT be most easily detected?
- d) Penguins inhabiting an island far away from the area where DDT was applied were found to contain DDT. Suggest the way in which the penguins might have come to contain DDT?
- e) Analysis of the small fish showed levels of DDT of 1-200ppm in the flesh and 40-200ppm in the fatty tissue. Suggest a reason why animals die of DDT poisoning in times of food shortage.
- f) When DDT was used, the first and second application killed 99% of the pests. Their numbers quickly recovered and the third application had little effect on the population. Explain why DDT did not eradicate the pests and why their number recovered quickly
- g) Suppose you are to develop a new pesticide, what qualities would you want it to have?

47. The graph below shows the variation of leaf area index for *Trifolium fragiform* and *Trifolium repens* with time

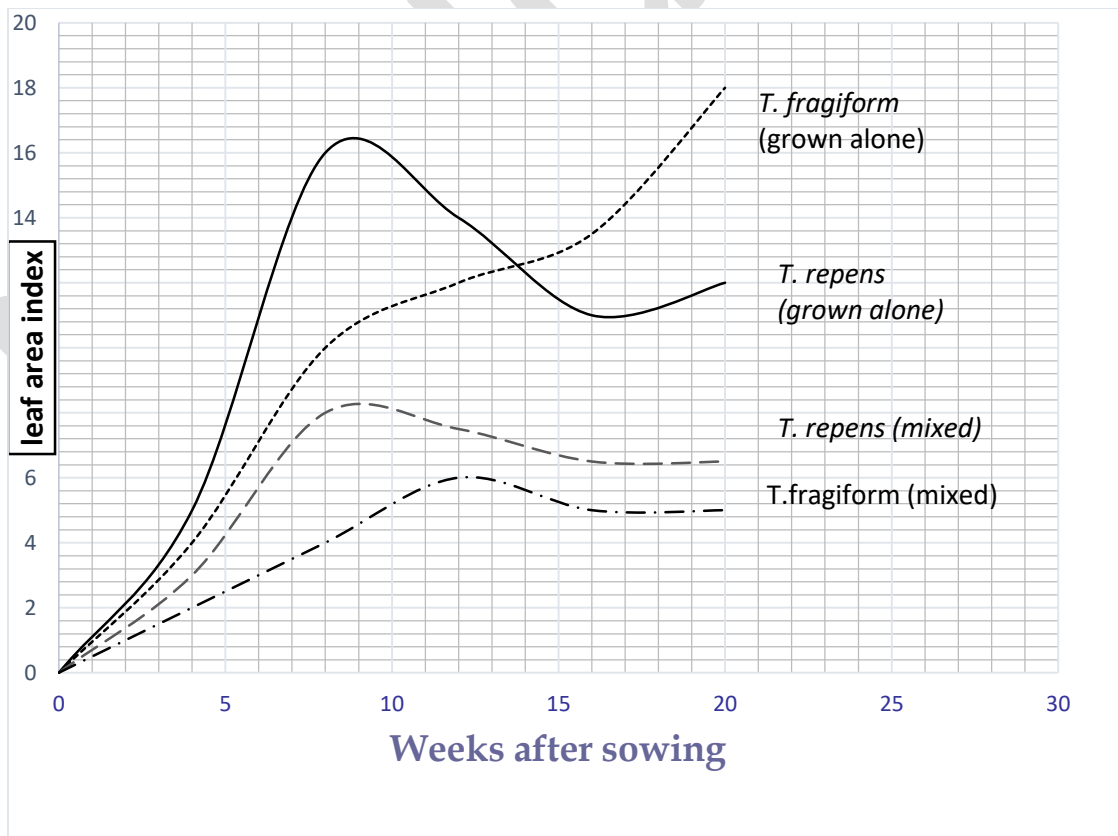

- a) Compare the;
 - i. Growth of *Trifolium* species grown separately
 - ii. Growth of *Trifolium* species grown together
- b) Why did the *Trifolium* species grown together not behave like the case of beetles above? Give evidence for your answer from the graph.
- c) State other factors that may affect the population of the beetles and clover in an ecosystem
- d) Explain the variation in other abiotic factors between the surface water and that at the lake bottom

A scientist carried out a research on two species of flour beetles (*Tribolium*) and clover (*Trifolium*). In research, she grew the beetles in the same medium and different media under different climatic conditions. On the other hand, she grew the plants together and separately. The following are her findings

Climate	Temperature /°C	Relative humidity/%	Results of interspecific competition	
			<i>Tribolium castaneum</i>	<i>Tribolium confusum</i>
Hot-wet	34	70	100	0
Hot-dry	34	30	10	90
Warm-wet	29	70	86	14
Warm-dry	29	30	13	87
Cool-wet	24	70	31	69
Cool-dry	24	30	0	100

- e) Comment on the effect of changing temperature and relative humidity on the population of *Tribolium* species
- f) Explain the observed behaviour of the *Tribolium* species over time
- g) What biological principle is demonstrated by the results in the table above
- h) Describe how interspecific competition may lead to speciation?

43. (a) State advantages of using biological agents to control pests over chemical pesticides (02marks)
 (b)The figure below shows percentage of leaves of strawberry occupied by two-spotted mites (prey) and predatory mites over a period of 16weeks.

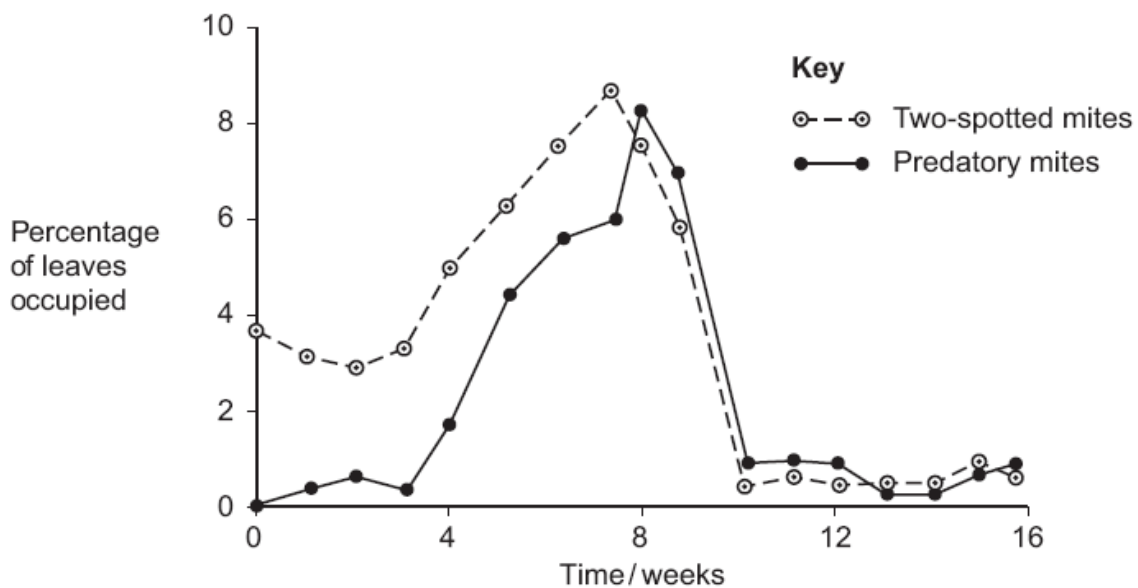

- i) Describe how the percentage of leaves occupied by predatory mites changes during the experiment. (02 marks)
- ii) Explain how the graph supports that the control of two spotted mites by a biological agent was successful (02 marks)
- c) Farmers who grow straw berry might decide not to use predatory mites. Suggest two reasons why. (02 marks)
- d) If the experiment was to be repeated, but after 10 weeks a chemical pesticide was sprayed on straw berry. Suggest and explain what would happen after 16 weeks (03 marks)

48. The table below shows characteristics of the principal seral stages in succession from an abandoned farm to mature forest.

Seral stage	Duration (years)	Canopy height (m)	Biomass (tones)
Farm growth	0-2	1-5	5-20
Secondary thicket	2-10	8-20	15-100
Secondary forest	10-80	15-50	100-150
Mature forest	>80	40-60	100-150

- (a) (i) What is meant by ecological succession? (2 marks)
- (ii) Describe how succession occurs in each seral stage above and give the general life form in each stage. (13 marks)
- (iii) In what ways is the succession above different from that which begins with a bare rock. (5 marks)
- (b) Phytoplankton consists of single celled photosynthetic organisms which are suspended in the surface water. The graphs show the relationship between the biomass of phytoplankton and depth at which it is found in two different lakes. Lake A has low nutrient concentration. Lake B has a high nutrient concentration.

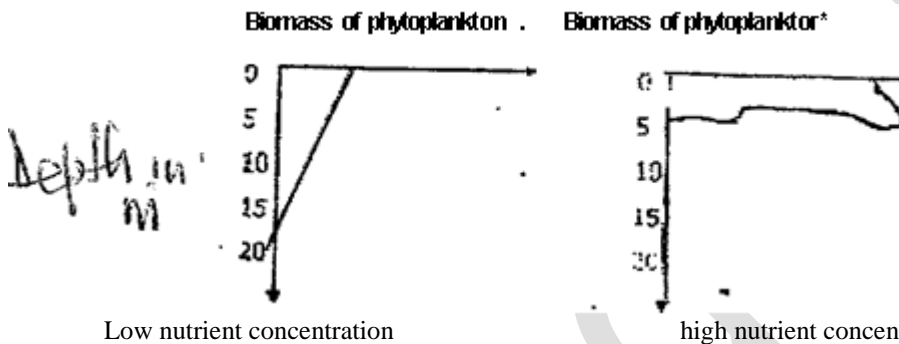

- i) Briefly describe a method by which you can measure the biomass of the phytoplankton. (2 marks)
- ii) Describe the effect of different nutrient concentrations on the distribution of phytoplankton in the two lakes. (04 marks)
- iii) Explain why the rate of biomass production at a depth of 5 metres was much higher in the Lake A than in Lake B. (04 marks)
- (c) Phytoplankton organisms do not live for long. After a short time they die and their remains decay.
 - i) Use this information to explain how application of large amounts of nitrate fertilizer to the land surrounding a lake might affect other organisms living in the lake. (03 marks)
 - ii) Suggest why a period of drought might increase the effect described in your answer in C (i) above. (01 mark)
- (d) Biological techniques may be used to monitor water pollution such as that caused by the addition of fertilizer. Explain used to monitor water pollution.
 - i) The presence or absence of indicator species. (02 marks)
 - ii) An index of diversity (02 marks)
 - iii) Biochemical oxygen demand. (02 marks)

49. In an experiment, the relationship between two insect species was studied by comparing their population over a period of time. *Icerya* is a pest on citrus fruit and *Rodolia* is a carnivore. The two species were simultaneously exposed to an orchard and their populations were determined over time. The results are shown in the table below;

Time/month		0	1	2	3	4	5	6	7
Population in thousands	<i>Rodolia</i>	2	70	200	630	300	70	50	50
	<i>Icerya</i>	700	690	680	545	193	90	68	67

- (a) On the same axis, plot the data in appropriate graph
- (b) (i) Describe the population changes in the two species
- (ii) Account for the relationship between the two populations of these insect species
- (iii) What is the technical term for the kind of relationship between the two populations of these insect species?
- (c) Outline the significance of;

- i. The population in the sixth and seventh months
 - ii. This relationship to humans
- (d) Outline the precautions you would take before introducing the two species simultaneously in the environment

50. The table below shows average mineral contents of sea water, river water and dry matter of marine brown algae. Study the table and answer the questions that follow.

ELEMENT	CONCENTRATION (PPM)		
	SEA WATER	RIVER WATER	DRY MATTER
Sodium	10,500	6.3	33,000
Calcium	1.350	4.10	5,200
Potassium	380	2.30	52,000
Strontium	8	0.08	1,400
Iron	0.01	0.67	700
Magnesium	0.002	0.012	53
Silicon	3	6.5	1,000
Carbon	28	11	345,000
Chlorine	19,000	7.8	4,700
Sulphur	885	3.7	12,000
Bromine	65	0.021	740
Boron	4.6	0.013	120
Fluorine	1.3	0.09	4.5
Nitrogen	0.5	0.23	15,000
Phosphorous	0.07	0.005	2,800

- (a) Comment briefly on the relative concentration of mineral elements in sea water and river water
- (b) Explain the difference in concentrations of elements in the two water bodies
- (c) Suggest why some minerals are more concentrated than others in the marine brown algae
- (d) Comment briefly on the differences in mineral concentrations between seawater and marine brown algae
- (e) (i) What is the source of mineral elements found in sea water?
(ii) Suggest the possible ways by which terrestrial ecosystems obtain minerals

END